

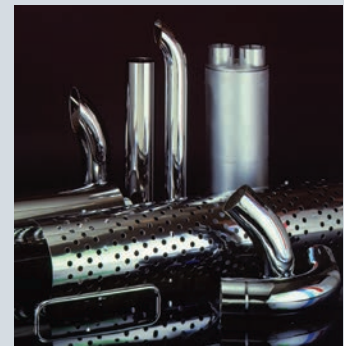

Exhaust Product Guide

for Medium- & Heavy-duty Vehicles
and Equipment

Mufflers • Clamps • Tubing / Connectors • Stacks / Tailpipes • Elbows • Hangers / Brackets • Shields



This publication contains a wide selection of standard mufflers and exhaust components for diesel-powered vehicles and equipment that operate in a variety of conditions. For assistance, contact Donaldson or your local Donaldson distributor.

Distributed by:

Our innovative products solve complex filtration and exhaust system challenges that improve people's lives, enhance engine and equipment performance and protect our environment.

Donaldson has the technical expertise, superior customer support and vast network of locations around the world to meet your toughest needs – from initial system design through replacement products.



Improve



Enhance



Protect

This publication contains a wide selection of standard exhaust components for both original equipment manufacturers and replacement parts for existing diesel-powered vehicles and equipment that operate in a variety of conditions. For assistance with muffler or accessory selection, contact your local Donaldson distributor or dealer.

Overview 2
 Exhaust Product Line..... 2
 Expanded Catalog Content and
 Where to Buy..... 4
 History..... 5
 Diesel Retrofit Emissions Solutions..... 6
 Engine Exhaust Flow & Airflow Calculations . 7
 Engine Aftermarket Exhaust Warranty..... 8

Accessories..... 9
 Exhaust System Components 10
 Common System Configurations..... 11
 Exhaust Joint/Connections 12
 Exhaust Clamps..... 13-17
 Heat Sleeves & Heat Wraps 18
 Flex Tubing & Cut to Length Flex 18-19
 V-Band Clamps for Large Mufflers..... 20
 V-Band Clamps for Flanged Connections..... 20
 V-Band Clamps 20
 Flared Connectors & Adapters..... 21
 Reducers/Expanders..... 22-23
 Connectors 22
 Tilt Cab Ball & Cone Connectors 23
 Y or Wye Adapter Pipe..... 23
 Splitter Tee Adapter..... 23
 Stack Caps..... 24
 Universal Swivel Hanger..... 24
 Universal Mounting Bracket 24
 Pipe Hangers 24
 Universal Pipe Guards & Clamps..... 24
 Elbows & Bent Tubes..... 25-28
 Straight Tubing & Stack Pipes 29-31
 Tailpipes..... 31
 Spark Arrestors..... 32
 Muffler Guards & Accessories..... 33
 Muffler Hangers..... 33
 Heavy-Duty Muffler Mounting Straps..... 33
 Heavy-Duty Hangers
 Grab Handles, Manifold Tube/Flange & Threaded
 Adapters 36
 Exhaust Ejectors & Check Valves 37-38
 Intake Accessories..... 39-51

Muffler Selection & Specifications.. 53
 Attenuation & Backpressure
 By Muffler Style & Inlet/Outlet Size..... 55
 Muffler Specifications by Part Number..... 60
 Muffler Specifications by Style & Inlet 67

Truck Engine Muffler Application 75
 Caterpillar..... 76
 Cummins 86
 Detroit Diesel..... 96
 International..... 102
 Mack..... 107

Cross Reference 113
 Manufacturers' Code Listing 113
 0-9..... 116
 A-Z..... 150

Shoptalk 161
 Shoptalk - Free Subscription! 161
 Purpose of an Exhaust System..... 162
 Muffler Design & Performance 162
 Exhaust Product Materials..... 163
 Noise Sources 164
 Truck Noise Control..... 165
 Rules of Thumb..... 166
 Emissions Devices & Acoustic Silencing... 166
 Familiar Sounds on the dBA Noise Scale... 166
 Emissions Mandates & Timing 166
 Diesel Particulate Matter (PM) Allowed
 per Horsepower-Hour (soot vials) 167
 Cutting & Installation Instructions
 for Flex Tubing..... 168
 Donaldson & Industry Acronyms..... 169
 Engine Brake & Exhaust Silencer 169
 SealClamp™ Installation Instructions . 170-171
 Terms & Definitions..... 172

Reference Material
 Engine Air & Exhaust Flow Guide..... 173

Part Number Index 181

Features and Benefits of Donaldson Mufflers

Low Backpressure

Better fuel economy and efficient engine performance

Aluminized Steel

Delivers long service life and is corrosion resistant

Lightweight Construction

Minimizes stress and vibration on mounting system

High Temperature Paint

Available on select product. Paint adds corrosion resistance and enhanced finish



Donaldson Mufflers

Donaldson exhaust systems are original equipment on most pre-2007 medium- and heavy-duty trucks manufactured in North America. Donaldson engineers work with many OE truck and off-road equipment manufacturers to design and build quality exhaust systems based on the specific performance.

Truck Mufflers for Every Budget

BEST (Part No. M101158 & M101181)



- 1 million mile warranty on M101158 – stainless steel Silent Partner™
- 500,000 mile warranty on M101181 – aluminized steel Silent Partner
- Superior acoustic performance – specifically addresses engine brake noise by silencing engine brake “bark”

BETTER (Part No. M100580)



- M100580 Donaldson muffler
- Meets all OEM back pressure, strength and life requirements
- Exhaust noise level is 4.5 - 7.5 dB(A) quieter than M100465 muffler

GOOD (Part No. M100465)

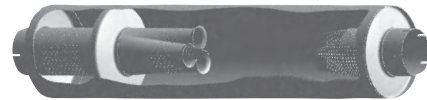

- The M100465 is the most common, most popular service muffler in the industry
- Low back pressure provides good fuel economy and efficient engine performance

What external characteristics differentiate mufflers?

- Shape of muffler (generally round or oval)
- Style (inlet/outlet configurations on the muffler)
- Materials

What internal characteristics differentiate mufflers?

- Wrapped (with insulation) or unwrapped
- Insulation sandwiched between an inner and an outer body
 - Reduces noise/high frequency
 - Lowers outer shell temperature
 - Reduces radiated heat
- Quantity, size, and position of internal baffles and tubes

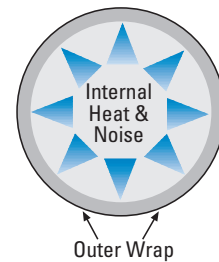

Exhaust System Configurations

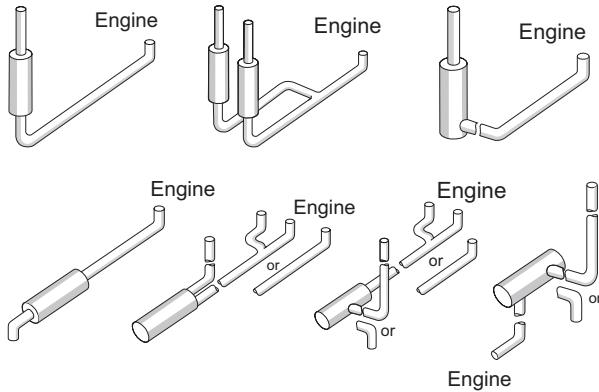

Exhaust Product Materials

A number of different materials are found in exhaust systems. Often different options are available for use in a single application. Since materials vary in strength, corrosion resistance, and price, a particular material may be preferred in individual applications and components. Some of the most common materials, their qualities, and their typical uses are listed in the following table.

Muffler Styles

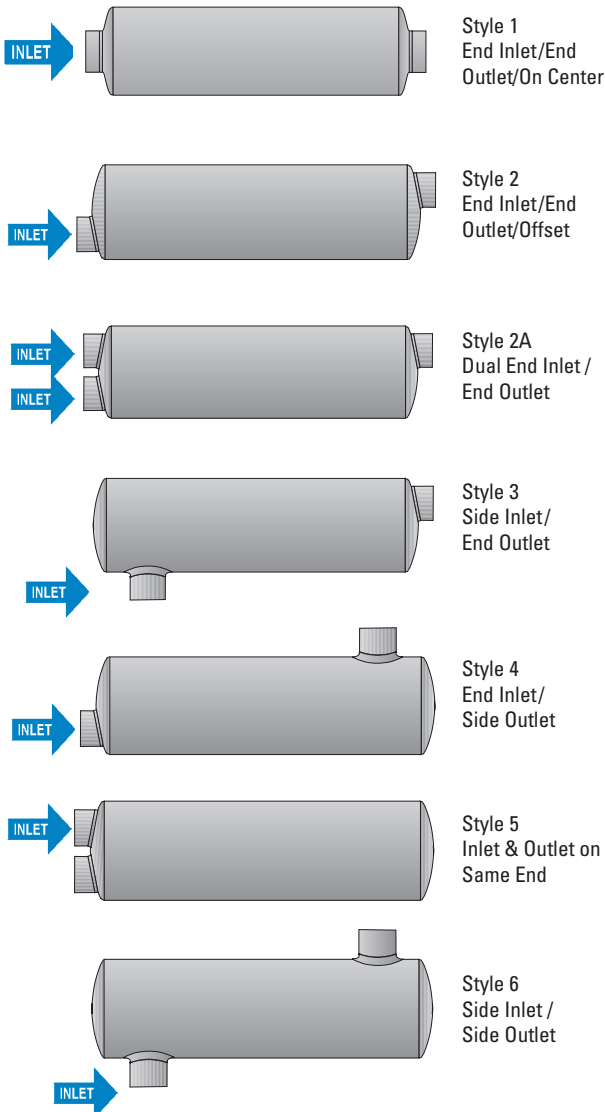

Materials*	Used in	Qualities
Aluminized Mild Steel	Mufflers	Good Corrosion Resistance
	Exhaust Components	
Stainless Steel (with and without aluminized coating)	Flexible Tubing	Stronger Excellent Corrosion Resistance
	Mufflers	
	Exhaust components	
	Emissions Products	
Chrome	Accessories	Bright Mirror Finish
Galvanized	Flexible Tubing	Low Material Cost Temperature Limit 600°F
Cold Rolled	Accessories	Poor Corrosion Resistance Low Cost

* See pg 163 for more further descriptions of materials used by Donaldson in exhaust system products.

New & Expanded Catalog Content

This edition of the Donaldson exhaust catalog includes the following additional information:

OVERVIEW



NEW

New Heavy-Duty Accessories

Newer and/or retrofit emissions systems weigh considerably more than the traditional OE exhaust system and require new mounting hardware to accommodate the extra weight. Our more popular heavy-duty brackets and clamps have been added.

& Specs

The estimated sound reduction (attenuation range in dbA) for all Donaldson mufflers has been added to the muffler selection tables starting page 55. We have also expanded the dimensional section by muffler style to include all muffler dimensions and muffler illustrations.

Muffler Dimensions

Muffler Sound Reduction

Cross Reference

Compared to our previous publication, this section include hundreds of new cross references. We do encourage you to use the Donaldson on-line cross reference for the latest information.

Shoptalk Section

Shoptalk is all about sharing helpful information to become more informed about Donaldson exhaust products and systems. This section includes installation tips for and fact sheets for many exhaust/emissions products and technologies.

Confused About Which Exhaust Clamp To Select or What Clamp Should be Used?

Depending on your exhaust joint and what you're connecting to, it's not always so easy to determine which one of our exhaust clamps is best for your needs.

Take a look at this new information on page 12 of our accessories section the next time you need a replacement clamp.



Where To Buy Donaldson Products?

Donaldson products are available through a variety of distribution outlets: OE dealers, independent warehouse distributors and exhaust-only distributors. Each of these distribution channels have their unique methods of servicing your needs to meet your business requirements.

To find the closest outlet in your region, visit www.donaldson-filters.com. Look in the Where to Buy section of our web site.

From Silencing to Emissions Reduction

1950s

When exhaust was about silencing -- we led the way! Frank Donaldson sold enough mufflers in 1951 to open our first exhaust manufacturing facility in Grinnell, Iowa in 1952.

1960s

In the 1960s, sound meters were used to measure noise levels (see image on right). Donaldson is one of the first manufacturers to introduce the use of aluminized steel in exhaust systems.



1970s

Donaldson introduces mufflers with integrated ejectors and wrapped mufflers. Wrapped mufflers reduced the overall exhaust system noise and the exterior body temperature. Donaldson SealClamp™ band-style exhaust clamp launched into the marketplace. Donaldson expands to Japan. In 1973, U.S. noise regulations went into effect for on-road vehicles – Donaldson offers a muffler line that was effective at noise reduction without loss of horsepower.



1980s

In 1981, Donaldson opens a new technical center. The center included two anechoic chambers which expanded our technical capabilities. Mufflers meet 1988 U.S. EPA truck noise regulations (sonic chokes and floating baffles).

1990s

When engine manufacturers needed help to meet the first U.S. Emissions regulations, innovations continued. In the early 1990s, we pioneered the design of integrated catalytic converter mufflers and diesel particulate solutions for three major U.S. engine and truck manufacturers. In the late 1990s, Silent Partner™ was the first muffler that effectively reduced engine brake noise without loss of power or fuel economy. During this decade, Donaldson expands exhaust manufacturing in Europe (France); Mexico (Guadalajara); and the United States (Alabama).

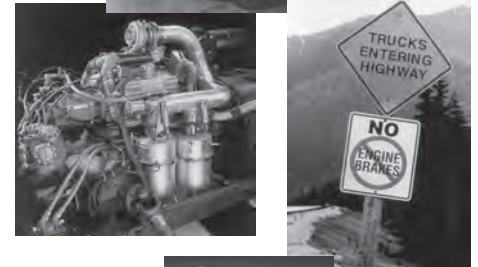

2000s

2001 Donaldson forms a group dedicated to emissions reduction efforts for diesel engines; begins retrofit projects; Spiracle™ crankcase filtration introduced to eliminate emissions from open crankcase vents. Mass production of CCMs for on-road OEs begins.



Since the early 1990s, Donaldson has sold more than a million DOC Mufflers.

2002 First of many CARB and EPA verifications for Donaldson retrofit emissions solutions; first company to verify tailpipe and crankcase solution (patented).

2003 Donaldson expands exhaust manufacturing in Aguascalientes, Mexico.

2004 Donaldson upgrades and expands heavy-duty engine test cell capabilities; U.S. MSHA accepts Donaldson high temp exhaust filter. New web-based Emissions Resource Center (www.donaldson.com/en/erc) established.

2005 DPF Cleaning System and DMF Muffler launched for emissions retrofit market. Donaldson introduces an active, smart DPF emissions solution for the most difficult duty cycles; low temperature, transient and extended idling.

2006 Donaldson expands European emissions staff and Mexico exhaust manufacturing to Monterrey; Donaldson improves Stepped SealClamp™.

2007 Donaldson expands OE emissions support with production of active and passive exhaust aftertreatment systems to meet U.S. EPA 2007 on-road emissions regulations.

2009 Donaldson produces urea and non-urea based NOx reduction systems for OE 2010 and retrofit for in-use vehicles.

Acronym Reference: See Shoptalk Section

Diesel Retrofit Emissions Solutions

www.donaldson.com/emissions



Governmental regulations across the globe are being implemented that reduce diesel emissions. These regulations affect both OE manufacturers and end users. Donaldson works with both OE manufacturers and fleets to design innovative, customized solutions. (See Shoptalk section for Diesel PM limits and global emissions regulations.)

In order to meet retrofit emissions regulations, diesel-powered vehicle owners around the world will be faced with major business decisions to become compliant with current regulations; choices include retrofit, refuel, rebuild, repower or replace.

For older vehicles that have five or more years of useful life available, fleet owners are electing to retrofit their vehicles to extend the life of their current equipment.

Donaldson takes a "total system approach" to retrofit – delivering patented solutions that reduce not just what comes out of your tailpipe, we also offer a solution that eliminates emissions generated from the engine crankcase (Spiracle™ crankcase filtration technology).

Donaldson has California ARB and U.S. EPA-verified solutions, an installation service network, and local Donaldson representatives that are ready to help you select the best solution for your fleet.

Do you have questions about meeting retrofit emissions regulations?

We have a specialized team of emissions experts that can help determine your emission reduction targets and then specify the right Donaldson solution, keeping in mind regulations, budgets and fleet size.

Emission Retrofit Sales Group

Email: emissionssales@donaldson.com

Phone: 866-675-2847

Web site: www.donaldson.com/emissions

Choices for Diesel Retrofit

Retrofit – new emission control devices on existing engines (filters, catalysts)

Refuel – cleaner diesel fuel (ULSD), emulsions or additives

Rebuild – repair/upgrade key components or engine reprogramming

Repower – put new or newer engine in existing equipment or chassis

Replace – vehicle/equipment condition less than the value of new engine

Internet Resource:

Emissions Resource Center

www.donaldson.com/en/erc

Emissions Retrofit Products

Retrofit solutions include cost-effective and high efficiency tailpipe and Spiracle™ crankcase filtration technologies plus our DPF cleaning system (DPF pulse cleaner and DPF Thermal Regenerator).

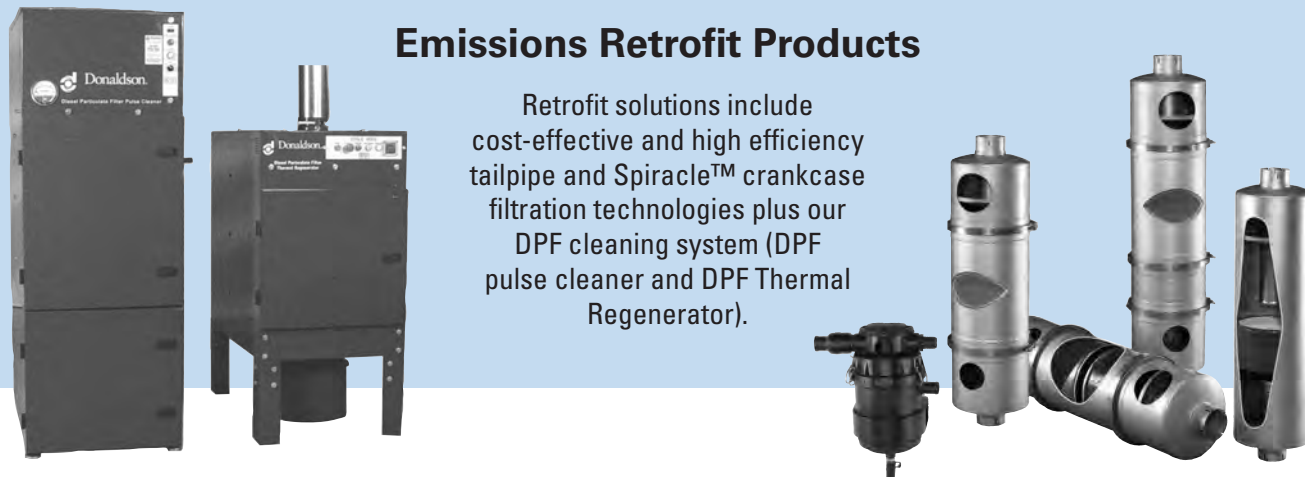

The calculations on the right are provided as a reference and may be helpful as you validate and select Donaldson mufflers and components.

For the most accurate engine airflow and exhaust flow rates, Donaldson recommends using the information supplied by your engine manufacturer.

Looking for Engine Exhaust Flow Guide?

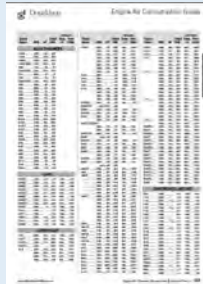

See Exhaust Flow Reference Section of this catalog.



Airflow guide should only be used as a reference document/ For proper muffler application, look to your engine supplier for the most accurate and current information.

Engine Exhaust Flow Rate Calculation

Exhaust flow rate may be calculated using the following formula. Exhaust temperature and intake airflow rate must be determined to calculate the exhaust flow rate. Exhaust temperature and manufacturers maximum backpressure may be approximated using the chart on the right.

$$\left(\frac{\text{Exhaust Temp. (°F)} + 460}{540} \right) \times \text{Intake Airflow (CFM)} = \text{Exhaust Flow (CFM)}$$

Engine Type	Engine Temperature	Maximum Backpressure
Diesel 2-Cycle Naturally Aspirated	= 900° F	4" Hg
Diesel 2-Cycle Turbo	= 750° F	3" Hg
Diesel 4-Cycle Naturally Aspirated	= 1000° F	3" Hg
Diesel 4-Cycle Turbo	= 900° F	3" Hg
Gasoline (all types)	= 1200° F	>4" Hg

Note: If you are spec'ing a dual muffler system, remember to divide engine's exhaust flow (CFM) by two

Engine Airflow Calculation

CFM intake rate is available from the engine manufacturer. If CFM specifications are not available, use the volumetric efficiency calculation. A simple calculation for cfm is to multiple the horsepower of your engine by 2.5.

4-Cycle Engine Airflow Calculation

$$\left(\frac{\text{Engine Size (CID)} \times \text{RPM}}{3456} \right) \times \text{Volumetric Efficiency} = \text{Intake Airflow (CFM)}$$

2-Cycle Engine Airflow Calculation

$$\left(\frac{\text{Engine Size (CID)} \times \text{RPM}}{1728} \right) \times \text{Volumetric Efficiency} = \text{Intake Airflow (CFM)}$$

Volumetric Efficiency

Engine volumetric efficiency ratings are best obtained from your engine manufacturer. Engines operating with electronic controls could have volumetric efficiency ratings of more than 2.0. Airflow on these engines should be verified by the engine manufacturer.

4 Cycle GAS Engine	Naturally Aspirated	= .70 - .80
2 and 4 Cycle DIESEL Engine	Naturally Aspirated	= .90
	Turbo*	= 1.50 - 3.00*

* If VE rating is not available, Donaldson recommends using the highest value to insure proper airflow.

The information below is the exhaust portion of our Engine Aftermarket Filtration & Exhaust Warranty Document: F110064 (February 2006)

OVERVIEW

Donaldson warrants its Aftermarket products against failure due to defects in materials and workmanship for the period specified under Terms and Conditions for the particular product. Donaldson’s obligation under this warranty covers replacing the failed product, including transportation charges, only. If the Donaldson product failure is the sole and direct cause of damage to the equipment on which the product was properly installed, Donaldson will reimburse reasonable costs to restore the equipment to the condition it was in immediately before the failure. This warranty does not cover failure due to misapplication, misuse, abuse, neglect, rust through and corrosion (mufflers), improper service practices or non-Donaldson approved modifications. Engine and equipment manufacturers warranties remain in effect when Donaldson products are used.

Donaldson must be notified in writing of any claims covered by this warranty within one year of the date of failure. Donaldson, at its discretion, will either physically visit the site where the alleged failure has been found; or, request that all parts, Donaldson and other relevant parts, be shipped prepaid to its General Office, in care of the Product Lab or as otherwise specified.

Terms & Conditions

Warranty coverage begins on the date and mileage the product is purchased by the user and expires when the specified number of years or miles has passed, whichever occurs first.

The length of warranty for replacement products provided under warranty coverage is the balance of the warranty period remaining on the product being replaced.

Warranty Length by Product

Exhaust Products	Warranty from Date of Delivery to User
Diesel Mufflers	
Vertical Installation	4 Years or 500,000 miles (800,000 km)
Horizontal Installation	3 Years or 500,000 miles (800,000 km)
Gas Mufflers	1 Year
Silent Partner™, Exhaust Silencer	
Stainless Steel	8 Years or 1,000,000 miles (1,600,000 km)
Aluminized Steel	4 Years or 500,000 miles (800,000 km)
Exhaust Accessories	1 Year
Chrome Parts	1 Year or 100,000 miles (160,000 km) (peeling & blistering only)
Flex Pipe	90 Days
Long-Life Flex Pipe	1 Year or 120,000 mile (200,000 km) (on-highway vehicles only)

Free Exhaust Accessory Poster

For mechanics and parts counter personnel, this "door width" sized poster (25" x 38" /635 mm x 965 mm) is available from Donaldson or your local Donaldson distribution outlet.

This handy visual makes it easy for your customers to identify the replacement accessories they're looking to replace.

The parts information is updated annually so if you have an old version, consider updating.

Poster Part No. F115023.



Donaldson offers an extensive line of accessories available in a variety of materials for both vertical and horizontal exhaust systems.



Heavy-Duty V-bands, Muffler Bands, Straps and Hangers

Section Index

Exhaust Accessories

Exhaust System Components	10
Common System Configurations.....	11
Exhaust Joint/Connections	12
Exhaust Clamps.....	13-17
SealClamp™ Band Clamps	13
Offset MaxGrip™ Bent Bolt.....	14
MaxGrip™ Bent Bolt	14
SealClamp Band Clamp	15
Torca® Clamps	16
U-Bolt Clamps.....	16
Muffler Body Band Clamps.....	17
Heavy-Duty Muffler Body Band Clamps	17
Heat Sleeves & Heat Wraps	18
Flex Tubing & Cut to Length Flex	18-19
Bellows Section.....	19
V-Band Clamps for Large Mufflers.....	20
V-Band Clamps for Flanged Connections..	20
V-Band Clamps	20
Flared Connectors & Adapters.....	21
Marmon Flange & Flares	21
Reducers/Expanders.....	22-23
Connectors	22
Tilt Cab Ball & Cone Connectors	23
Y or Wye Adapter Pipe.....	23
Splitter Tee Adapter.....	23
Stack Caps.....	24
Universal Swivel Hanger.....	24
Universal Mounting Bracket	24
Pipe Hangers	24
Universal Pipe Guards & Clamps.....	24
Elbows & Bent Tubes.....	25-28
Straight Tubing & Stack Pipes	29-31
Tailpipes.....	31
Spark Arrestors.....	32
Muffler Guards & Accessories	33
Muffler Hangers.....	33
Heavy-Duty Muffler Mounting Straps.....	33
Heavy-Duty Hangers	
for Round Mufflers.....	34
for School Buses.....	35
for Oval Mufflers	35
Universal Applications.....	35
Grab Handles, Manifold Tube/Flange & Threaded Adapters	36
Exhaust Ejectors & Check Valves	37-38

Intake Accessories

Rubber Elbows	39-41
Charge Air Connectors	42
Worm-Drive Hose Clamps.....	43
Vacuator™ Valves for Air Cleaner	44
Intake Indicators & Indicator Fittings	45
Inlet Hoods	48
Air Ram™ Truck.....	46
Metal & Plastic Hoods.....	47
Moisture Eliminator & Stack Extensions ..	49
Air Cleaner Mounting Bands	
Metal Bands	50
FPG Plastic & Metal.....	51

Common Components Of Heavy Duty Exhaust Systems



Bent Tubes & Elbows

For directional changes of exhaust flow in exhaust systems. Available in common angles (90, 67 and 45) for both O.D. and I.D. tube connections.



Wye Connector

For joining legs of dual manifold outlet to form a single exhaust system. Wye connectors can provide an additional 3 to 7 dbA exhaust noise reduction over that of the primary muffler and may also be used to replace conventional wye pipe.



Resonator

Secondary noise reduction component that generally provides 2 to 3 dbA additional noise reduction.



Tubing (Straight or Flexible)

Straight or flexible tubing for connection to muffler or resonator. Purchased in standard lengths and cut to size if needed.

Muffler

The primary component in an exhaust system for engine noise reduction.

Exhaust Filter or Emissions Device

Traditional exhaust systems with mufflers are transitioning from noise reduction devices to emissions reduction devices to meet federal and state regulations. The primary component in the emissions device converts or captures exhaust emissions to reduce overall engine emissions. An emissions reduction device can be an add-on installed into the existing system or a retrofit muffler replacing the original muffler.



Hanger

Secures the muffler or pipe horizontally or vertically to chassis or side of cab.



Reducers, Connectors & Expanders

Shorter length tubes used for connecting two other exhaust pipes of different diameters or the same diameter.

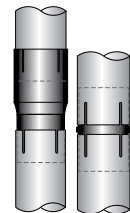

Spark Arrestor

An exhaust system add-on used to capture sparks emitted from internal combustion engines through the exhaust system. All Donaldson models are U.S. Forest Service approved.



Splitter Tee Adapter

An adapter pipe with one inlet and two outlet tubes used to convert a single exhaust system to a dual exhaust system.



Stack or Tail Pipes

Vertically mounted outlet pipe; available in curved outlet or straight squared configuration.



Note: Super stacks also available that can offer an additional 2 to 3 dbA noise reduction with no back-pressure penalty.

Stack Cap

Moisture protector used on vertically mounted mufflers or stack pipes.



Clamps

Exhaust systems use a variety of exhaust clamps. Selecting the proper clamp for the job is critical to a strong, reliable joint connection. Common types include u-bolt, band Clamps, bent bolt clamps and v-band clamps.



From the manifold to the exhaust stack, you'll find Donaldson can be the best source for your exhaust system accessories. The system diagrams below represent typical components found on exhaust systems.

Vertical System Components (cab or stanchion mounted)

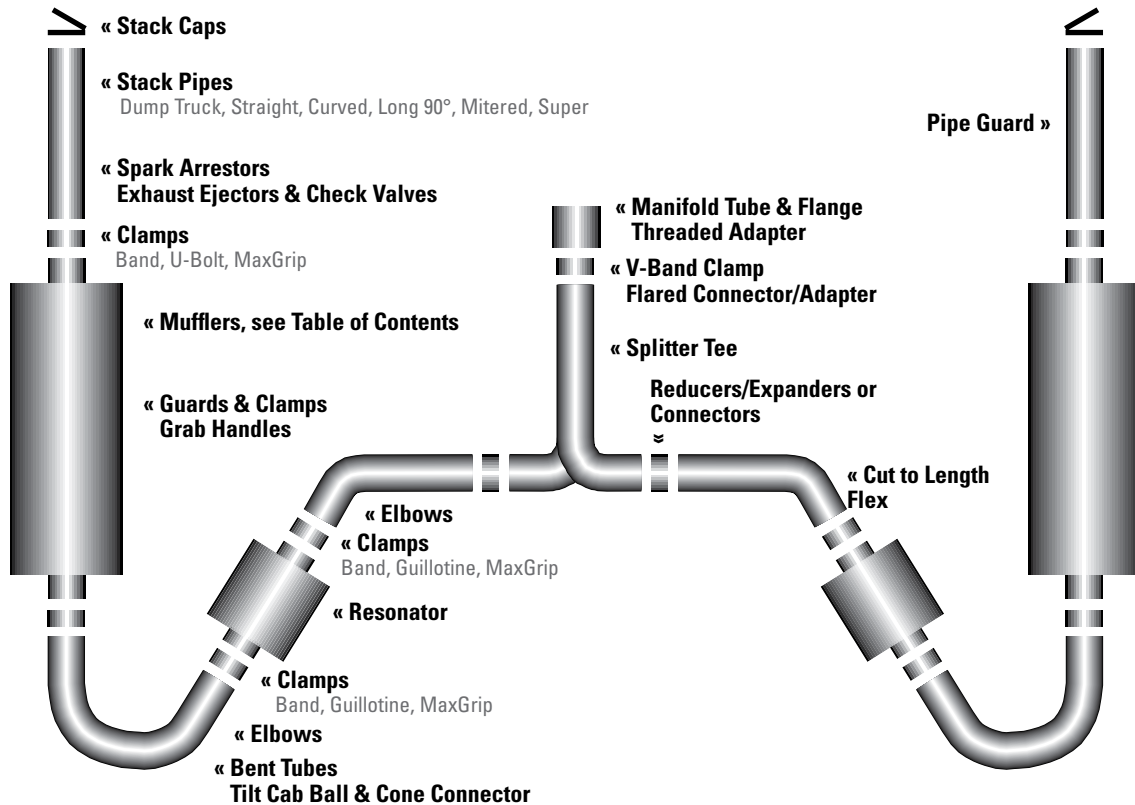

Horizontal System Components (Chassis mounted)

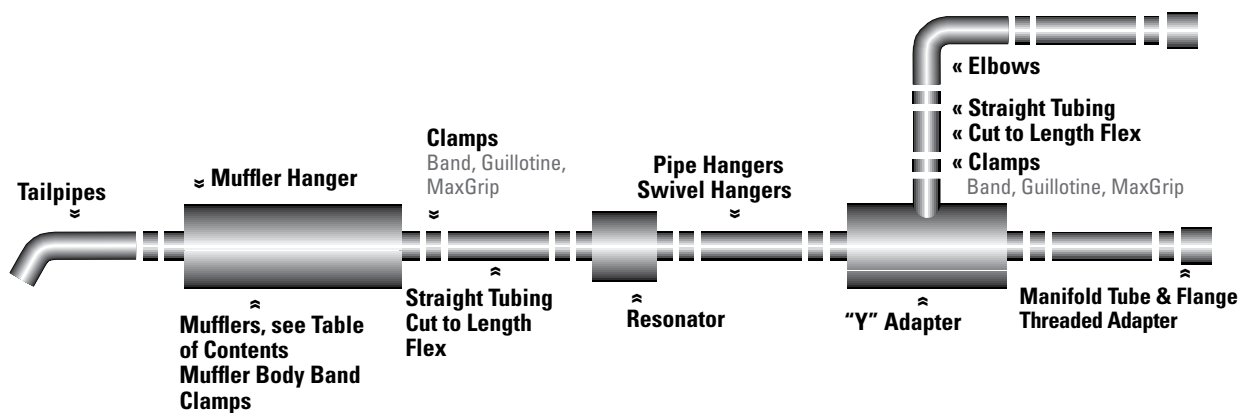

Exhaust Joint/Connections

Guide to Selecting the Best Clamp for the Exhaust Joint Connection

ACCESSORIES

Type of Joint/Connection

Type of Clamp to Apply

(blue text = primary clamp recommendation)



Exhaust - tube to tube Standard OD

- MaxGrip™ Bent Bolt**
- Stepped SealClamp™ (Aluminized or Stainless)**
- Offset MaxGrip™ Bent Bolt
- SealClamp™ Flat Band (Aluminized or Stainless)
- Narrow Band (Aluminized)
- U-Bolt (any type, any material)

MaxGrip™ Bent Bolt

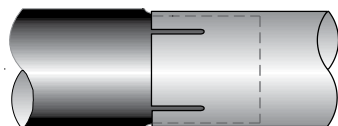

Slotted Tube to Shrunken OD

- MaxGrip™ Bent Bolt**
- SealClamp™ Flat Band (Aluminized or Stainless)
- Narrow Band (Aluminized)
- U-Bolt (any type, any material)

Offset MaxGrip™ Bent Bolt



Offset MaxGrip™ Bent Bolt (chevron design)

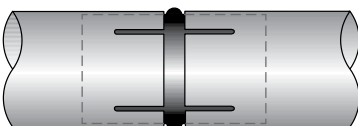

Slotted Tube to Slotted Tube (butt with internal connector)

- MaxGrip™ Bent Bolt (2 required per connection)**
- SealClamp™ Flat Band (Aluminized or Stainless)
- U-Bolt (any type, any material, 2 required per connection)

Flat Band SealClamp™

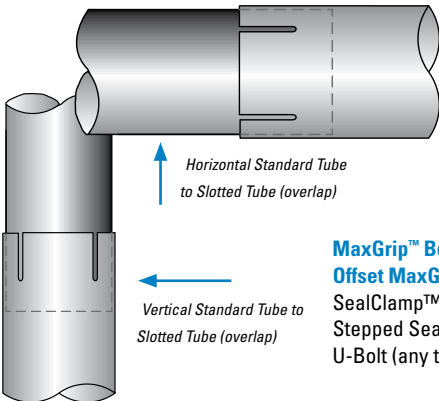

Horizontal Standard Tube to Slotted Tube (overlap)

Vertical Standard Tube to Slotted Tube (overlap)

- MaxGrip™ Bent Bolt**
- Stepped SealClamp™ (Aluminized or Stainless)**
- Offset MaxGrip™ Bent Bolt
- SealClamp™ Flat Band (Aluminized or Stainless)
- Narrow Band (Aluminized)
- U-Bolt (any type, any material)

Stepped SealClamp™



- MaxGrip™ Bent Bolt**
- Offset MaxGrip™ Bent Bolt**
- SealClamp™ Flat Band (Aluminized or Stainless)
- Stepped SealClamp™ (Aluminized or Stainless)
- U-Bolt (any type, any material)

U-Bolt Single, Round Band

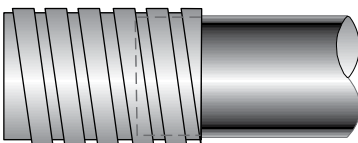

Standard Tube to Flex Tube

- Stepped SealClamp™ (Aluminized or Stainless)**
- Offset MaxGrip™ Bent Bolt (with chevron)**

U-Bolt Double, Flat Band

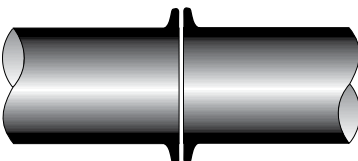

Flared, Lipped or Flange Connection

V-Band Clamps



Narrow Band Accuseal®



Based on the type of exhaust joint, your choice of clamp to apply may be limited. But, when you're looking to purchase a clamp based on specific performance features, the information below may be helpful as you try to select the proper clamp for the application.

Clamp Performance Rankings (10 high - 1 low)

Holding Force

- 10 Offset MaxGrip™ Bent Bolt
- 10 V-band Clamp
- 8 MaxGrip™ Bent Bolt
- 7 U-bolt (any style or material)
- 5 SealClamp™ (any style or material)
- 3 Narrow Band (aluminized)

Ease of Assembly

- 9 MaxGrip Bent Bolt
- 9 Narrow Band (aluminized)
- 8 Offset MaxGrip Bent Bolt
- 8 Stepped SealClamp (aluminized or stainless)
- 6 U-bolt (any style or material)
- 5 V-band Clamp
- 3 SealClamp Flat Band (aluminized or stainless)

Sealing Properties

- 10 Stepped SealClamp (aluminized or stainless)
- 9 V-band Clamp
- 8 SealClamp Flat Band (aluminized or stainless)
- 6 MaxGrip Bent Bolt
- 6 Offset MaxGrip Bent Bolt
- 5 Narrow Band (aluminized)
- 3 U-bolt (any style or material)

Appearance

- 10 Stepped SealClamp (stainless)
- 10 V-band Clamp
- 9 Stepped SealClamp (aluminized)
- 7 Offset MaxGrip Bent Bolt
- 7 Narrow Band (aluminized)
- 7 SealClamp Flat Band (stainless)
- 6 SealClamp Flat Band (aluminized)
- 5 MaxGrip Bent Bolt
- 5 U-bolt (double, flat band, chrome)
- 4 U-bolt (double, flat band, zinc)
- 4 U-Bolt (single, round band, chrome)
- 2 U-Bolt (double, round band, steel)
- 1 U-Bolt (single, round band, steel)

Tube Deformation

- 10 V-band Clamp
- 9 Stepped SealClamp (aluminized or stainless)
- 8 Offset MaxGrip Bent Bolt
- 8 SealClamp Flat Band (aluminized or stainless)
- 7 MaxGrip Bent Bolt
- 7 Narrow Band (aluminized)
- 2 U-bolt (double, flat band, chrome or zinc)
- 2 U-Bolt (double, round band, steel)
- 1 U-Bolt (single, round band, chrome or steel)

Price

- 10 U-Bolt (single, round band, steel)
- 9 U-Bolt (double, round band, steel)
- 8 Narrow Band (aluminized)
- 8 SealClamp Flat Band (aluminized)
- 8 U-bolt (double, flat band, zinc)
- 7 MaxGrip Bent Bolt
- 7 Offset MaxGrip Bent Bolt
- 7 SealClamp (other than aluminized)
- 6 U-Bolt (single, round band, chrome)
- 3 U-bolt (double, flat band, chrome)
- 1 V-band Clamp

What Features Are Most Important to You?

- _____ Holding Force
- _____ Ease of Assembly
- _____ Sealing Properties
- _____ Tube Deformation
- _____ Appearance
- _____ Price

Offset MaxGrip™ Bent Bolt Clamp

Donaldson introduces a new series of bent bolt clamps for use on exhaust systems. The clamps are manufactured in heavy duty aluminized steel to minimize corrosion.

- Clamps are reusable
- Aluminized band, stainless steel welds, deburred strap edges and finished with a heat resistance silver paint
- Self positioning for easy installation
- Protected by patents, both issued and pending



Offset MaxGrip Bent Bolt

For Muffler to Stack Connections

Nominal I.D.	Functional I.D.	Range	Part
in	mm	inches	Number
4.00	102	4.04-4.21	M002164
5.00	127	5.04-5.21	M001865



Offset MaxGrip Bent Bolt

For Tube to Flex Connections

Nominal I.D.	Functional I.D.	Range	Part
in	mm	inches	Number
4.00	102	4.04-4.21	M002134
5.00	127	5.04-5.21	M002135

MaxGrip™ Bent Bolt Clamp

- More holding power than any other clamp tested
- Donaldson patented technology
- Clamps are reusable
- Aluminized band, stainless steel welds, and deburred strap edges finished with heat resistant black paint
- Use these clamps on slotted, lapped tube connections and manifold connections
- Ideal for use on Donaldson "captured" slots for maximum sealing
- Coated bolts and threads
- Hardened flange nuts



MaxGrip Bent Bolt Clamp

Nominal I.D.	Functional I.D.	Range	Part
in	mm	inches	Number
1.75	44	1.79-1.96	M001866
2.00	51	2.04-2.21	M001867
2.50	64	2.54-2.71	M001756
3.00	76	3.04-3.21	M001702
3.50	89	3.54-3.71	M001502
3.75	95	3.73-3.90	M001593
3.88	99	3.89-4.06	M001432
4.00	102	4.04-4.21	M001503
4.25	108	4.21-4.38	M001566
4.50	114	4.54-4.71	M001703
5.00	127	5.04-5.21	M001668
5.25	133	5.21-5.38	M001504
6.00	152	6.04-6.21	M001505
6.25	159	6.21-6.38	M001799
6.75	171	6.83-7.00	M001506

SealClamp™ – The Original Band Clamp

Preformed & Flat Styles

Used to seal muffler inlets, outlets, elbow joints, flex pipes, and other system connections. Also minimizes noise and exhaust gas leaks.

SealClamps are easy to install! There's no need to weld or disconnect your exhaust system.

When installed, the wide band conforms to the shape of straight or flex pipe, and seals without distorting the pipe.

- For overlapping I.D. to O.D. slotted joints and flex tube
- Flat band style may be used for butt-style joints in light duty applications
- Nuts and bolts fit both 9/16" and 14mm wrenches
- Reduces noise and exhaust leaks
- Installs easily – no disconnecting or welding necessary
- Available in aluminized and stainless steel
- Stainless models have improved corrosion resistance and high temperature strength compared to aluminized



Stepped Preformed SealClamp

Stepped Preformed SealClamp

- Full 360° clamping area
- No flex pipe pinching
- Available in stainless and aluminized

O.D. Pipe		Stainless	Aluminized
in	mm		
2.50	64	X007829	
3.00	76	X007830	X007833
3.50	89	X007831	X007834
4.00	102	X007784	X007824
5.00	127	X007785	X007805
6.00	152	X009076	

U.S. Patent Nos. 6,116,659; 6,634,607 B2; 6,796,004 B2



Stepped Preformed SealClamp is Individually packaged with installation instructions

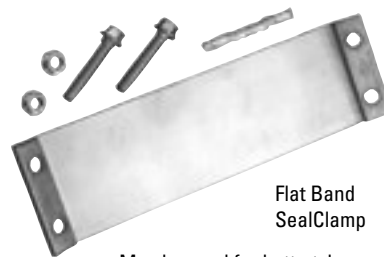

Flat Band SealClamp

May be used for butt-style joints in light duty applications

Flat Band SealClamp

O.D. Pipe		Stainless	Aluminized
in	mm		
2.00	51	X004536	
2.25	57	X004537	
2.50	64	X004476	
2.75	70	X004538	
3.00	76	X004478	
3.50	89	X004480	X006204
4.00	102	X004482	X006203
4.50	114	X004962	
5.00	127	X004484	X006202
6.00	152	X004539	



Donaldson Flat Band SealClamps are Individually packaged. Loose parts inside the shrink wrapped package.

Torctite®



Torctite® Lap Joint

O.D. Pipe		Aluminized	Stainless	Polished Stainless
in	mm			
2.00	51		J190056	
2.25	57		J190057	
2.50	64		J190058	
2.75	70		J190059	
3.00	76	J009604	J190060	
3.50	89	J009605	J190061	
4.00	102	J009606 ¹	J009623 ³	P222740
4.50	114	J190054	J190062	
5.00	127	J009607 ²	J009624 ⁴	P222741
6.00	152	J190055	J190063	P222742

1 - Consider X007824 as an alternative
 2 - Consider X007805 as an alternative
 3 - Consider X007784 as an alternative
 4 - Consider X007785 as an alternative

Easyseal®



May be used for lap and butt-style joints

O.D. Pipe		304 Bright Stainless
in	mm	
2.00	51	J000210
2.25	57	J000212
2.50	64	J000211
2.75	70	J000213
3.00	76	J000214
3.50	89	J000215
4.00	102	J000216
4.50	114	J000219
5.00	127	J000217
6.00	152	J000218

Easyseal® is a registered trademark of Torca Co.

Accuseal®



Accuseal® is a registered trademark of Torca Co.

O.D. Pipe		Aluminized
in	mm	
2.00	51	J000204
2.25	57	J000205
2.50	64	J000206
2.75	70	J000207
3.00	76	J000200
3.50	89	J000201
4.00	102	J000202
4.50	114	J000208
5.00	127	J000203
6.00	152	J000209

Standard U-Bolt Clamps (All models 3/8-16" UNC-2A)



- Single, round band
- Cold rolled steel or Chrome



- Double, round band



- Double, flat band

O.D. Pipe		Steel	Chrome
in	mm		
2.00	51	P206403	
2.25	57	P206404	
2.50	64	P206405	
2.75	70	P206406	
3.00	76	P206407	
3.25	83	P206408	
3.50	89	P206409	
4.00	102	P206410	J009486
5.00	127	P206411	J009487
6.00	152	P207667	

O.D. Pipe		Steel
in	mm	
2.00	51	J000220
2.25	57	J000222
2.50	64	J000221
2.75	70	J000224
3.00	76	J000227
3.50	89	J000228
4.00	102	J000230
4.50	114	J000231
5.00	127	J000232
6.00	152	J000233

O.D. Pipe		Zinc	Chrome
in	mm		
3.00	76	P206600	P206608
3.50	89	P206601	P206609
4.00	102	P206602	P206610
5.00	127	P206603	P206611
6.00	152	P207596	P207598

Muffler Body Band Clamps for Traditional Mufflers



- High temperature black finish (matches finish on new off-road mufflers)
- Band width 1.25" (32mm)

Muffler Body Band Clamps

---- A ----		---- B ----		---- C ----		Part Number
in	mm	in	mm	in	mm	
6.00	152	3.75	95	3.75	95	M002117
6.62	168	4.00	102	4.00	102	M002118
8.50	216	5.00	127	5.00	127	M002119
9.00	229	5.50	140	5.50	140	M002120
10.08	256	6.00	152	6.00	152	M002121
11.06	281	6.50	165	6.50 <td 165	M002122	
11.84	301	7.00	178	7.00	178	M002123

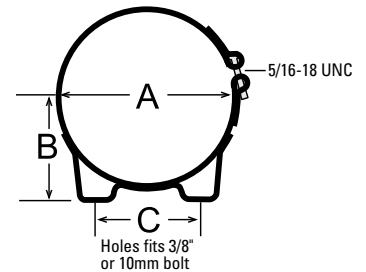

Heavy-Duty Muffler Body Band Clamps

Clamp Notes:

- Pinch bolts are not included
- Most use 3/8-1-1/2" long grade 5 or 8 grade bolts
- Band width 1.25" (unless noted)
- Reuse existing frame mounting bolts
- Materials are either zinc-plated or aluminized mild steel.

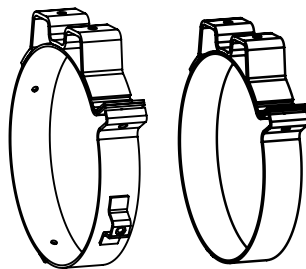

P227803

P230281

No heat shield stand off

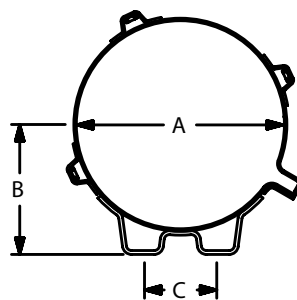

W-Foot Body Bands

- Use for vertical or horizontal mounting
- Bolts not included

for Heat Shield Applications

---- A ----		---- B ----		---- C ----		Part Number
in	mm	in	mm	in	mm	
10.00	254	6.28	160	3.5	89	P227803
11.00	269	6.50	165	6.5	165	P229513
13.00	330	7.75	197	6.5	165	P230283

No Heat Shield Applications

---- A ----		---- B ----		---- C ----		Part Number
in	mm	in	mm	in	mm	
10.00	254	6.28	160	3.5	89	P230282
11.00	269	6.50	165	6.5	165	P230281
13.00	330	7.75	197	6.5	165	P230045

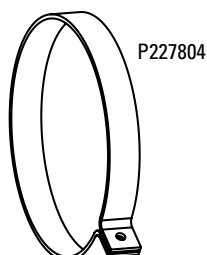

P227804

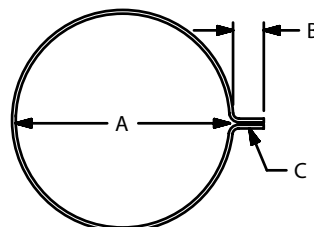

Band width 1.5" (38mm)

Muffler Body Bands for Schools Buses

---- A ----		---- B ----		---- C ----		Part Number
in	mm	in	mm	in	mm	
10.00	256	1.75	44	.40	10	P228241 ⁽¹⁾
11.00	279	1.75	44	.40	10	P227804 ⁽²⁾

1. Bluebird conventional bus with Cat Engine Works
2. Bluebird rear engine bus

Heat Sleeves & Heat Wrap

Heat sleeves or heat wrap could reduce the outside temperature of a bare pipe by up to 300°F to 400°F.

Heat Sleeves

Slips onto 3" to 5" dia. pipe



NEW

Length	Part Number
12"	P235764
18"	P235765
24"	P235766

Heat Wrap

2" wide roll, easy to install on any pipe

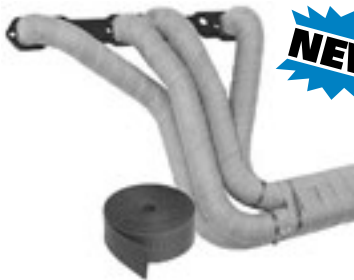

NEW

Length	Part Number
2"X50' (600") Roll	P235767

Sleeve & Wrap Clamps

Wrap clamps make installation easy!
No tools needed.



NEW

Length	Part Number
2 PC of 18" Long Clamp	P235768
12 PC of 18" Long Clamp	P235769

ACCESSORIES

Flex Tubing & Cut to Length Flex

Flex Tubing

- Flex tubing (and cut lengths) should be installed in a half extended state. Donaldson flex tubing ships in the half extended state.
- Material thickness for stainless and galvanized is 0.015"
- Sized by flex I.D.
- Material thickness

Flex Tubing

--- I.D. --- in	mm	10 ft. (3 m) Lengths		25 ft. (7.6 m) Lengths ¹	
		Stainless	Galvanized	Stainless	Galvanized
2.00	51	P226151	P226148		
2.50	64	P226152	P226149		
3.00	76	P226144	P226140	P226132	P226129
3.50	89	P226145	P226141	P226133	P226154
4.00	102	P226146	P226142	P226156 ²	P226155 ²
5.00	127	P226147	P226143	P226158 ²	P226157 ²
6.00	152	P226153 ¹	P226150 ¹		

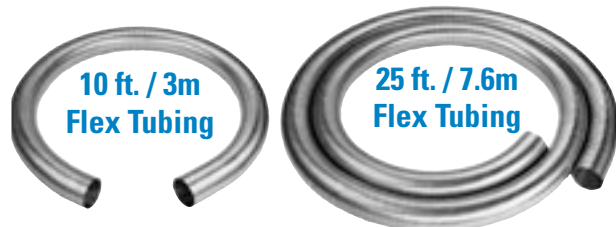

1 - Size exceeds shipping limits by North American small package carriers. This item must ship by truck.
2 - Shipped on pallet, product is not boxed.

Cutting & Installation Instructions for Flex Tubing - Please see page 168

Standard Cut to Length Flex



- Deburred ends
- Sized by flex I.D.
- Stainless and galvanized material thickness - 0.015"
- Measured fully extended



Close-up of deburred edge

Standard Cut to Length Flex

--- I.D. ---		Overall Length		Stainless	Galvanized
in	mm	in	mm		
3.00	76	12.00	305	J240003	
		18.00	457	P206552	
		24.00	610	J240004	
3.50	89	12.00	305	J240005	
		18.00	457	P206553	
		24.00	610	J024850	
4.00	102	12.00	305	J240006	P224479
		18.00	457	P206554	J024754
		24.00	610	J024836	J024835
		36.00	914	J034673	J034743
		12.00	305	J240007	P224481
5.00	127	18.00	457	P206555	J024755
		24.00	610	J024838	J024837
		36.00	914	J034674	J034744
		18.00	457	P206556	
6.00	152	30.00	762	P206559	

Flex Cut Lengths with Finished Ends



- Flex tubing (and cut lengths) should be installed in a half extended state. Donaldson flex tubing ships in the half extended state.
- One end O.D., one end I.D. slotted
- Sized by flex I.D.
- Overall length includes finished ends
- Welded tube ends

Cut-to-Length Flex - Finished Ends

--- I.D. ---		Overall Length		Galvanized
in	mm	in	mm	
3.00	76	18.00	457	P206544
4.00	102	18.00	457	P206546
5.00	127	18.00	457	P206547

Long-Life Cut to Length Flex



- Improved flexibility
- Consistent product quality—optimized material choice/consistency
- Heavier gauge stainless material over standard flex (0.018" gauge)
- Up to 8 times longer life than conventional flex
- Less leakage and lower emissions during truck start up
- Simplified installation—installation strip and flow direction
- Ends square cut and deburred
- Installation length indicator
- 12 month/120,000 mile/200,000 km warranty (on-highway vehicles only)

Donaldson patented technology

Long-Life Flex

--- I.D. ---		Mid Length ¹		Stainless
in	mm	in	mm	
4.00	102	12.00	305	P224412
		15.00	381	P224415
		18.00	457	P224418
5.00	127	21.00	533	P224421
		15.00	381	P224515
		18.00	457	P224518
		21.00	533	P224521

¹ - Length measured in half compressed state

Recommended clamps:

Preformed SealClamp or Offset MaxGrip Bent Bolt

V-Band Clamps

V-Band Clamps for Large Diameter Mufflers



- The V-band clamp is a common clamp for Donaldson retrofit mufflers
- The unique design reduces service time creates a reliable, leak-free seal between components
- Piloted v-insert section, facilitates reassembly and alignment for clamping

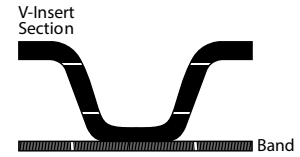
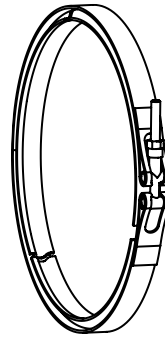

- Body Dia. - in	- mm	Part Number
10.0	254	P227750
11.0	279	P212925
13.0	330	P229851

V-Band Clamps for Pipes and Turbo Housing Flanges



- Used to connect vehicle exhaust pipe flange to turbo or engine manifold
- May also hold the turbo housing flanges
- Built to withstand high temperatures produced by heavy-duty engines/turbos
- Manufactured to the highest tolerances and meet or exceed OEM specifications for material and quality standards

Cat	Part Number	Nominal Diameter		V-Insert Sections					
		in	mm	--- A ---		--- B ---		--- C ---	
		in	mm	in	mm	in	mm	in	mm
3406, 3406B, 3176	P206607	5.88	149	0.40	10	0.28	7	0.88	22
3176T	P222018	4.75	121	0.40	10	0.28	7	0.88	22

Cummins	Part Number	Nominal Diameter		V-Insert Sections					
		in	mm	-- A --		-- B --		-- C --	
		in	mm	in	mm	in	mm	in	mm
B Series, #3903652	J009618	3.21	82	0.26	7	0.14	4	0.75	19
C Series	P222017	4.13	105	0.26	7	0.14	4	0.75	19
L10, M11	P222018	4.75	121	0.40	10	0.28	7	0.88	22
V555, V902, V903	J009612	3.88	99	0.40	10	0.28	7	0.88	22

Detroit Diesel	Part Number	Nominal Diameter		V-Insert Sections					
		in	mm	-- A --		-- B --		-- C --	
		in	mm	in	mm	in	mm	in	mm
6-71T, 12V71, 8.2N, 8.2T	P206606	4.81	122	0.21	5	0.28	7	0.88	22
6V53, 6V71, 6V92, 8V92	P206604	3.82	97	0.21	5	0.28	7	0.88	22
8.2 N, #2069773	J009611	4.06	103	0.24	6	0.28	7	0.88	22
8V71T	P213191	5.81	148	0.21	5	0.28	7	0.88	22
8V71T, 16V-71, 16V92T, 6V92, 8V92	P210110	5.25	133	0.21	7	0.14	4	0.75	19
8V92, 8V71, 4-53, 6-71	P206605	4.5	114	0.21	5	0.28	7	0.88	22
Series 60	P206607	5.88	149	0.40	10	0.28	7	0.88	22

Cross Section

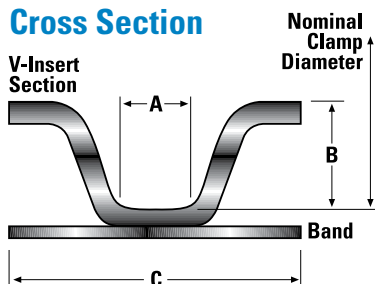

IH	Part Number	Nominal Diameter		V-Insert Sections					
		in	mm	-- A --		-- B --		-- C --	
		in	mm	in	mm	in	mm	in	mm
DT466	J009613	4.33	110	0.21	5	0.28	7	0.88	22

Mack	Part Number	Nominal Diameter		V-Insert Sections					
		in	mm	-- A --		-- B --		-- C --	
		in	mm	in	mm	in	mm	in	mm
48RU2341, 4ME21409	J009614	4.61	117	0.16	4	0.28	7	0.75	19

Flared Connectors - All 16 ga. Aluminized Steel

O.D. -- A -- in (mm)	I.D. -- B -- in (mm)	O.D. -- C -- in (mm)	-- D -- in (mm)	E	-- F -- in (mm)	Flared Connector	V-Band Clamp	Application
3.00 (76)	3.02 (77)	3.62 (92)	4.00 (102)	22°	0.75 (19)	P207619	P206604	DD 6V 71
3.50 (89)	3.63 (92)	4.25 (108)	4.00 (102)	22°	0.75 (19)	P207581	P206605	8V-71-VT-555
4.00 (102)	4.02 (102)	4.75 (121)	4.00 (102)	22°	0.75 (19)	P207620	P206606	6 71-12V 71



P207619

O.D. -- A -- in (mm)	I.D. -- B -- in (mm)	O.D. -- C -- in (mm)	-- D -- in (mm)	E	-- F -- in (mm)	Flared Connector	V-Band Clamp
3.50 (89)	3.52 (89)	4.19 (106)	4.75 (121)	45°	2.12 (54)	P207568	P206605
4.00 (102)	4.02 (102)	4.70 (119)	4.75 (121)	45°	2.50 (64)	P207567	P206606
5.00 (127)	5.02 (128)	5.70 (145)	4.75 (121)	45°	3.00 (76)	P207566	P206607



P207568, P207567, or P207566

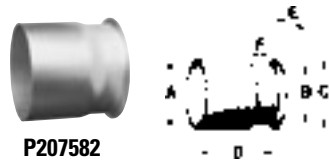

P207582

O.D. -- A -- in (mm)	I.D. -- B -- in (mm)	O.D. -- C -- in (mm)	-- D -- in (mm)	E	-- F -- in (mm)	Flared Connector	V-Band Clamp	Application
4.00 (102)	3.63 (92)	4.25 (108)	3.81 (97)	22°	0.75 (19)	P207582	P206605	8V 71

I.D. / O.D. -- A -- in (mm)	O.D. -- C -- in (mm)	-- D -- in (mm)	E	Flared Connector	V-Band Clamp
3.00 (76) ¹	3.75 (95)	1.50 (38)	20°	P206612	P206604
	3.92 (100)	2.25 (57)	20°	J009479	J009611
3.50 (89) ¹	4.19 (106)	1.50 (38)	22°	P206613	
3.50 (89) ²	4.29 (109)	1.50 (38)	22°	J009391	P206605
4.00 (102) ¹	4.75 (121)	1.50 (38)	22°	P206614	P206606
5.00 (127) ²	5.50 (140)	5.25 (133)	45°	J009393	
	5.69 (145)	3.00 (76)	22°	P206615	P206607
	5.86 (149)	5.00 (127)	20°	J009629 ³	



P206614



J009629

Adapter with
Pyrometer Fitting
(1/4" NPT)



- 1 - I.D. Dimension
- 2 - O.D. Dimension
- 3 - Adapter has pyrometer fitting

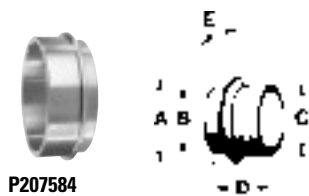

P207584

Lipped Flange

O.D. -- A -- in (mm)	I.D. -- B -- in (mm)	O.D. -- C -- in (mm)	-- D -- in (mm)	E	Flange	V-Band Clamp	Application
5.01 (127)	4.25 (108)	4.80 (122)	1.94 (49)	20°	P207584	P210110	Air Research Turbo

Marmon Flanges & Flares NEW

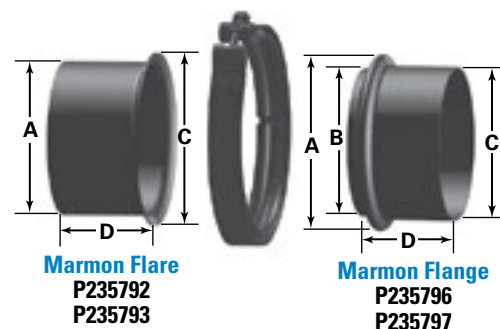

Marmon Flare
P235792
P235793

Marmon Flange
P235796
P235797

Join parts together for leakproof and serviceable connections with a V-Band Clamp. All components made from 304 SS.

	O.D. -- A -- in (mm)	I.D. -- B -- in (mm)	O.D. -- C -- in (mm)	-- D -- in (mm)	Part No.	V-Band Clamp
Marmon Flare	4.00 (102)	—	4.63 (118)	3.00 (76)	P235792	P206606
	5.00 (127)	—	5.63 (143)	3.00 (76)	P235793	P206607
Marmon Flange	4.72 (120)	3.80 (97)	4.00 (102)	3.00 (76)	P235796	P206606
	5.79 (147)	4.96 (126)	5.00 (127)	3.00 (76)	P235797	P206607

I.D. - I.D.

Reduces O.D. pipe of different sizes. 16 gauge aluminized steel.

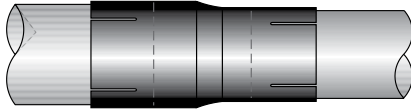

-- I.D. -- in mm	-- I.D. -- in mm	Length in mm	Part Number
2.50 64	2.00 51	6.00 152	P207382
2.75 70	2.50 64	6.00 152	P207385
3.00 76	2.50 64	6.00 152	P206313
	2.75 70	6.00 152	P207386
3.50 89	3.00 76	6.00 152	P206314
4.00 102	3.00 76	6.00 152	P206315
	3.50 89	8.00 203	P206316
5.00 127	4.00 102	6.00 152	P206317
6.00 152	5.00 127	8.00 203	P206318



I.D. - O.D.

Reduces larger O.D. pipe to smaller I.D. pipe. Also used as muffler bushing or manifold outlet. 16 gauge aluminized steel.



-- I.D. -- in mm	-- O.D. -- in mm	Length in mm	Part Number
2.50 64	2.00 51	6.00 152	P207397
3.00 76	2.50 64	6.00 152	P206319
	2.75 70	6.00 152	P207401
3.50 89	3.00 76	6.00 152	P206320
4.00 102	3.00 76	6.00 152	P206321
	3.50 89	6.00 152	P206322
4.50 114	4.00 102	6.00 152	J190046
5.00 127	4.00 102	6.00 152	P206323
6.00 152	5.00 127	6.00 152	P207402



O.D. - I.D.

Reduces larger I.D. pipe to smaller O.D. pipe. 16 gauge aluminized steel.



-- O.D. -- in mm	-- I.D. -- in mm	Length in mm	Part Number
2.50 64	2.00 51	6.00 152	P207389
2.50 64	2.25 57	4.00 102	J008942
3.00 76	2.50 64	6.00 152	P206324
3.50 89	3.00 76	6.00 152	P206325
4.00 102	3.00 76	6.00 152	P206326
	3.50 89	6.00 152	P206327
4.50 114	4.00 102	6.00 152	J190041
5.00 127	4.00 102	6.00 152	P206328
6.00 152	5.00 127	6.00 152	P207394



Connectors

I.D. - I.D.

Connects O.D. pipes of the same size. 16 gauge aluminized steel.



--- I.D. --- in mm	-- Length -- in mm	Part Number
2.00 51	6.00 152	P207405
2.50 64	6.00 152	P206371
3.00 76	6.00 152	P206372
3.50 89	6.00 152	P206373
4.00 102	6.00 152	P206374
5.00 127	6.00 152	P206375
6.00 152	6.00 152	P207408

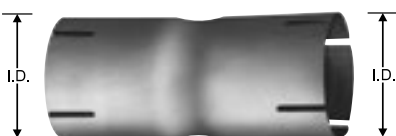

I.D. - O.D.

Connects O.D. and I.D. pipes of the same size. 16 gauge aluminized steel.

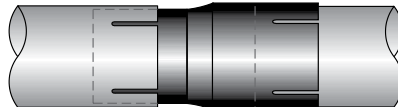

I.D.-O.D. in mm	-- Length -- in mm	Part Number
2.00 51	6.00 152	P207411
2.50 64	6.00 152	P206366
2.75 70	6.00 152	P207413
3.00 76	6.00 152	P206367
3.50 89	6.00 152	P206368
4.00 102	8.00 203	P206369
5.00 127	8.00 203	P206370
6.00 152	6.00 152	P207414



O.D. - O.D.

Connects I.D. pipes of the same size. Also used on manifold outlet. Connector has tube stop. 16 gauge aluminized steel.

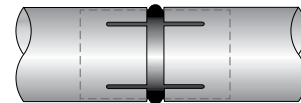

O.D.-O.D. in mm	-- Length -- in mm	Part Number
2.50 64	6.00 152	P206361
3.00 76	6.00 152	P206362
3.50 89	6.00 152	P206363
4.00 102	8.00 203	P206364
5.00 127	8.00 203	P206365



O.D. - O.D.

Reduces I.D. pipe of different sizes. 16 gauge aluminized steel.

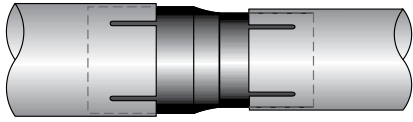

-- O.D. -- in	mm	-- O.D. -- in	mm	Length in	mm	Part Number
3.00	76	2.50	64	6.00	152	J190042
3.50	89	3.00	76	6.00	152	J190044
4.00	102	3.00	76	6.00	152	J009648
		3.50	89	6.00	152	J190045
5.00	127	4.00	102	8.00	203	J009649
6.00	152	5.00	127	8.00	203	J009650



Tilt Cab Ball & Cone Connectors

- 16 gauge aluminized steel construction



Ball Connector
P205976 - 4" Pipe I.D.
P206300 - 5" Pipe I.D.



Cone Connector
P205979 - 4" Pipe O.D.
P206299 - 5" Pipe O.D.

Standard "Y" Adapter Pipe

- 16 gauge aluminized steel construction

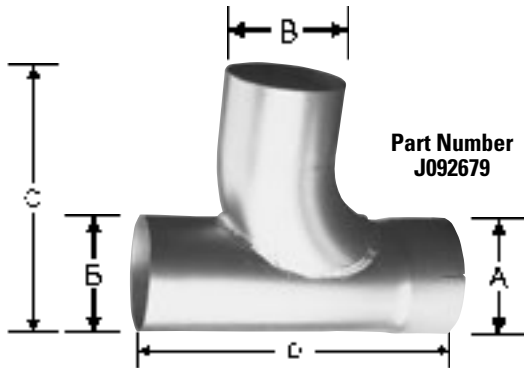

- A (I.D.) - in	mm	- B (O.D.) - in	mm	----- C ----- in	mm	----- D ----- in	mm	Part Number
4.00	102	4.00	102	9.00	229	14.00	356	J092679
5.00	127	5.00	127	10.50	267	15.00	381	J092689

Splitter Tee Adapter

- Converts single exhaust pipe to dual exhaust system
- 16 gauge aluminized steel

(A) in	mm	(B) in	mm	Truck ID (C) in	mm	Leg OD (D) in	mm	Part Number
17.50	445	12.00	305	4.00	102	4.00	102	P206297
26.00	660	14.00	356	5.00	127	5.00	127	P206298

Band width 1.5" (38mm)

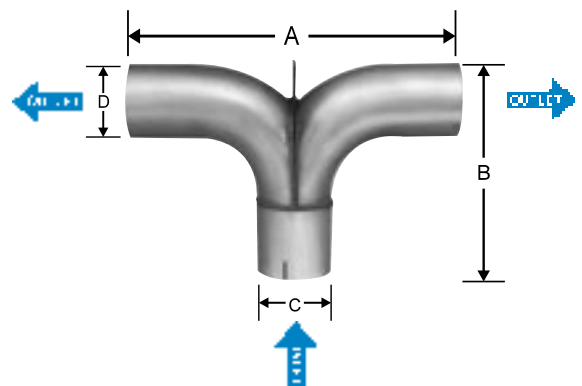

Stack Caps

The exhaust stack cap is designed to be mounted on top of a vertical straight exhaust stack pipe and prevents water and debris from entering the stack. The stack cap is not water-tight during pressure washes or under strong wind conditions. Use where exhaust gas temperatures are less than 1000° F / 537° C.

For proper installation, the exhaust cap needs clearance for counterweight rotation and should be installed at a point that allows for this without interference.

The exhaust cap should be placed on the outer diameter of the stack pipe. Allow approximately ¼" of clearance between cap and top of stack.

O.D. Pipe Size in	mm	Zinc Plated	
		Chrome	
1.50	38	P270530	
1.75	44	P270531	
2.00	51	P270532	
2.25	57	P270533	
2.50	64	P270534	
2.75	70	P270535	
3.00	76	P270536	P271507
3.50	89	P270538	P271508
4.00	102	P270539	P270837
4.50	114	P270540	
5.00	127	P270541	P270838
5.50	140	P270542	
6.00	152	P270543	P271511

P270539 - Zinc Plated



P270837 - Chrome



- High temperature corrosion-resistant finish
- Single bolt mount
- Nylon stop for quiet operation
- Metal bushing for high temperature use

Universal Swivel Hanger

- Heavy reinforced rubber pad
- Double pivot design improves flexibility and installation
- One piece construction installs in seconds
- 11 gauge cold rolled steel construction



P206507 - 9" length
J008167 - 13" length

Universal Mounting Bracket

- For 4" (102 mm) and 5" (127 mm) pipes
- 3/8"-16 UNC-2A(4)
- Heavy gauge hot rolled steel construction
- Expands to 10" (254mm)

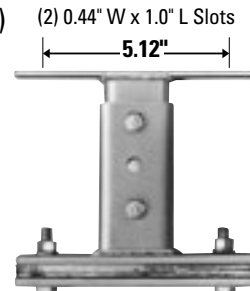

P207784

Pipe Hangers

- Pre-punched holes (0.41" dia.) for easy installation
- 12 gauge hot rolled steel construction
- 12" overall bar length, width 0.88"
- 3/8"-16 UNC bolts/nuts included

Pipe Hangers

Pipe Dia. in	mm	Part Number
		P206523
3.50	89	P206524
4.00	102	P206525
5.00	127	P206526



Universal Pipe Guards & Clamps

- 180° wrap coverage
- 48" (1219mm) length
- Polished stainless steel
- Shipped with protective film on one side
- Clamps must be ordered separately

Universal Pipe Guards & Clamps

Pipe Dia. in	mm	Stainless ¹	Clamp Kit
4.00	102	P206543	P206508
5.00	127	P206543	P206509
6.00	152	P206543	P224492

1 - Requires clamp kit for installation

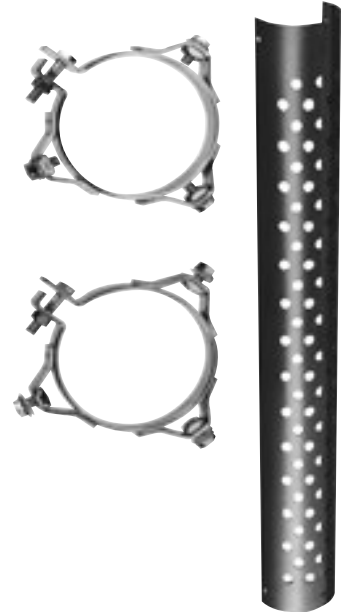

Pipe Guard Clamp Kits

- Two clamps per kit
- Chrome plated
- 12 gauge cold rolled steel construction

90° O.D. - I.D.

- 16 gauge aluminized or chrome plated steel
- One end O.D., one end I.D. slotted

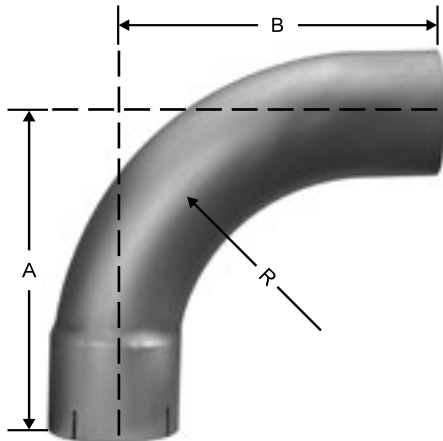

Diameter O.D.-I.D.		Leg Length (A)		Leg Length (B)		Center Line Radius (R)		Aluminized	Chrome
in	mm	in	mm	in	mm	in	mm		
2.00	51	9.00	229	9.00	229	5.00	127	P207333	
		6.38	162	6.38	162	4.00	102	J008671	
2.50	64	6.25	159	6.25	159	4.00	102	P206339	
		12.00	305	12.00	305	5.00	127	P207335	
2.75	70	6.38	162	6.38	162	5.00	127	P216172	
3.00	76	8.00	203	8.00	203	5.00	127	P206340	
		14.00	356	14.00	356	5.00	127	P206341	
3.50	89	9.00	229	9.00	229	5.00	127	P206342	
		12.00	305	12.00	305	5.00	127	P224669	
		16.00	406	16.00	406	5.00	127	P206343	
4.00	102	8.00	203	8.00	203	4.50	114		P224671
		8.00	203	8.00	203	5.00	127	J008681	
		10.00	254	10.00	254	4.50	114		P207345
		10.00	254	10.00	254	7.00	178	P206344	
		18.00	457	18.00	457	4.50	114		P206353
		18.00	457	18.00	457	7.00	178	P206345	
4.50	114	25.00	635	32.00	813	7.00	178	P207338	
		12.00	305	12.00	305	7.00	178	J190002	
5.00	127	8.50	216	8.50	216	5.50	140	J190003	J190004
		11.00	279	11.00	279	5.50	140	P207339	J009547
		15.00	381	15.00	381	7.50	191		P207346
						10.00	254	P206347	
6.00	152	18.00	457	18.00	457	7.50	191		P206354
						10.00	254	P206348	
		25.00	635	32.00	813	10.00	254	P207340	
		15.00	381	15.00	381	10.00	254	P207341	
		26.00	660	26.00	660	10.00	254	P206350	

90° O.D. - O.D.

- 16 gauge aluminized or chrome plated steel
- Both ends O.D.

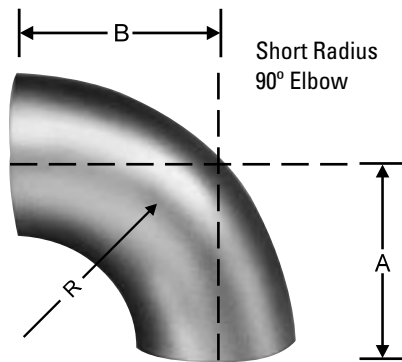
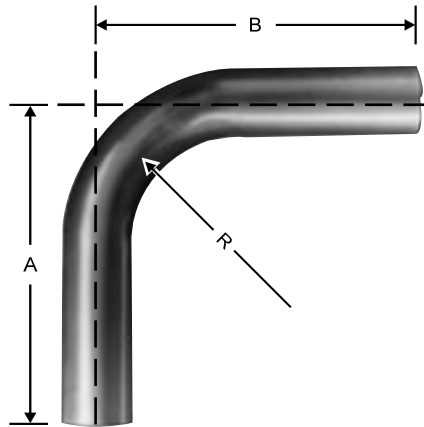

Diameter O.D.-O.D.		Leg Length (A)		Leg Length (B)		Center Line Radius (R)		Aluminized	Chrome	Stainless		
in	mm	in	mm	in	mm	in	mm					
2.00	51	9.00	229	9.00	229	5.00	127	P207322				
2.25	57	10.00	254	10.00	254	4.00	102	P216174				
2.50	64	12.00	305	12.00	305	5.00	127	P207324				
2.75	70	12.00	305	12.00	305	5.00	127	P207325				
3.00	76	3.50	89	3.50	89	3.00	76	P206397				
		6.00	152	6.00	152	4.00	102	P207362				
		10.00	254	10.00	254	5.00	127	P207326				
		14.00	356	14.00	356	5.00	127	J190013				
3.50	89	4.00	102	4.00	102	4.00	102	P206398		P235770 ¹		
		8.00	203	8.00	203	4.00	102	P207363				
		9.00	229	9.00	229	5.00	127	J190014				
		12.00	305	12.00	305	5.00	127	P207327				
		16.00	406	16.00	406	5.00	127	P207328				
4.00	102	4.50	114	4.50	114	4.00	102	P206399				
		4.50	114	4.50	114	4.50	102			P235771 ²		
		8.00	203	8.00	203	4.00	102	P207364				
		9.00	229	15.00	381	4.00	102	P207330				
		12.00	305	12.00	305	4.00	102	P206346				
		18.00	457	18.00	457	4.50	114		J190016			
						7.00	178	P207329				
		25.00	635	25.00	635	5.00	127	J190017				
		5.00	127	5.50	140	5.50	140	5.50	140	P206400		P235772 ²
		10.00	254	10.00	254	5.50	140	P207365				
11.00	279	16.00	406	5.50	140	P207332						
15.00	381	15.00	381	7.50	191		J190019					
				10.00	254	P207331						
		20.00	508	20.00	508	10.00	254	P206349				
		25.00	635	25.00	635	8.00	203	J190020				
6.00	152	6.50	165	6.50	165	6.00	152	P207361				
		10.00	254	10.00	254	6.00	152	P207366				
		23.00	584	23.00	584	10.00	254	P216175				

1- 409 Stainless Steel
2- 439 Stainless Steel

67° O.D. - O.D.

- 16 gauge aluminized steel
- Both ends O.D.
- For Peterbilt Truck

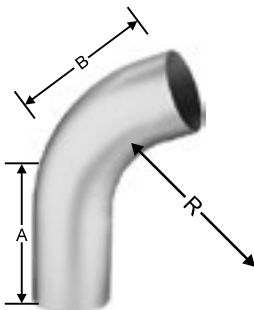

Diameter O.D.-O.D.		Leg Length (A)		Leg Length (B)		Center Line Radius (R)		Part Number
in	mm	in	mm	in	mm	in	mm	
5.00	127	7.50	191	11.00	279	8.00	203	J009560

ACCESSORIES

60° O.D. - O.D.

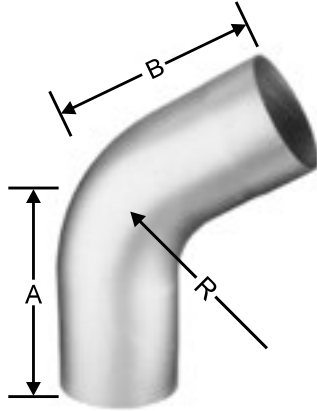

- 16 gauge aluminized steel
- Both ends O.D.

60° O.D. - I.D.

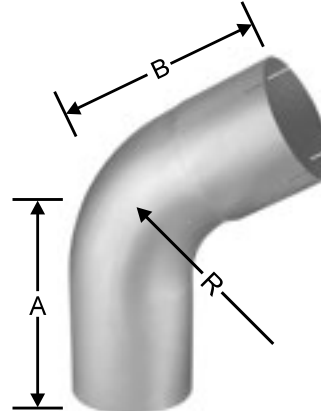

- 16 gauge aluminized steel
- One end O.D., one end I.D. slotted

Diameter O.D.-O.D.		Leg Length (A & B)		Center Line Radius (R)		Part Number
in	mm	in	mm	in	mm	
4.00	102	8.00	203	5.00	127	J009644
5.00	127	8.00	203	5.50	140	J009645

Diameter O.D.-I.D.		Leg Length (A & B)		Center Line Radius (R)		Part Number
in	mm	in	mm	in	mm	
3.50	89	8.00	203	5.00	127	J009639
4.00	102	8.00	203	5.00	127	J009640
5.00	127	8.00	203	5.50	152	J009641

45° O.D. - I.D.

- 16 gauge aluminized or chrome plated steel
- One end O.D., one end I.D. slotted

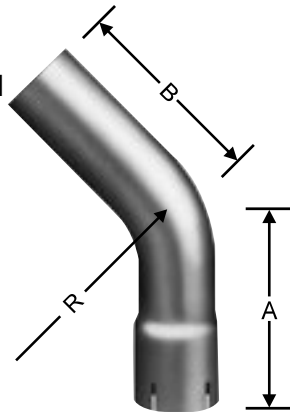

Diameter O.D.-I.D.		Leg Length (A & B)		Center Line Radius (R)		Aluminized	Chrome
in	mm	in	mm	in	mm		
2.50	64	6.00	152	4.00	102	P206279	
3.00	76	7.00	178	5.00	127	P206280	
3.50	89	8.00	203	5.00	127	P206281	
4.00	102	8.00	203	4.50	114		P206285
		9.25	235	7.00	178	P206282	
		12.00	305	5.00	127	J190023	
5.00	127	8.00	203	8.00	203	J190025	
		8.00	203	7.50	191		P206286
		12.00	305	8.00	203	P206283	
		15.00	381	5.50	140	J190027	
6.00	152	8.00	203	6.00	152	P207359	

Bent Tubes for Trucks

Kenworth Truck Bent Tubes

Kenworth Part No.	Donaldson Part No.	Dia. O.D. in	mm	Application
K180-5419	J018110	5.00	127	28° Elbow
K180-14764L	J038611	5.00	127	Left Hand Elbow
K180-14764R	J038612	5.00	127	Right Hand Elbow

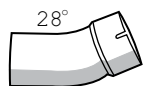

J018110

J038611

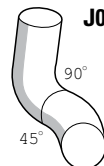

J038612

Mack Truck Bent Tubes

Mack Part No.	Donaldson Part No.	- Dia. O.D. in	mm	Application
4ME21698	J028528	4.00	102	R & RD Models



J028528

Therm couple Fitting

45° O.D. - O.D.

- 16 gauge aluminized or chrome plated steel
- Both ends O.D.

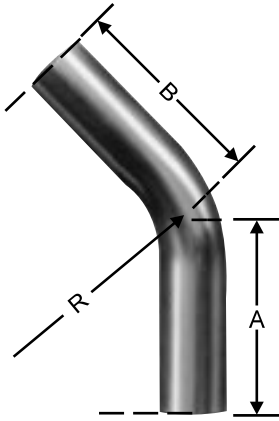

Diameter O.D.-O.D.		Leg Length (A)		Leg Length (B)		Center Line Radius (R)		Aluminized	Chrome	Stainless
in	mm	in	mm	in	mm	in	mm			
2.00	51	6.00	152	6.00	152	5.00	127	P207347		
2.50	64	6.00	152	6.00	152	5.00	127	P207349		
2.75	70	6.00	152	6.00	152	5.00	127	P207350		
3.00	76	7.00	178	7.00	178	5.00	127	P207351		
3.50	89	8.00	203	8.00	203	4.00	127			P235787 ¹
3.50	89	8.00	203	8.00	203	5.00	127	P207352		
4.00	102	8.00	203	8.00	203	4.00	102	P207353		
4.00	102	8.00	203	8.00	203	4.50	102			P235788 ²
5.00	127	8.00	203	8.00	203	5.50	140	P207354	P216169	P235789 ²
6.00	152	8.00	203	8.00	203	6.00	152	P207355		

1- 409 Stainless Steel
2- 439 Stainless Steel

ACCESSORIES

30° O.D. - O.D.

- 16 gauge aluminized steel
- Both ends O.D.

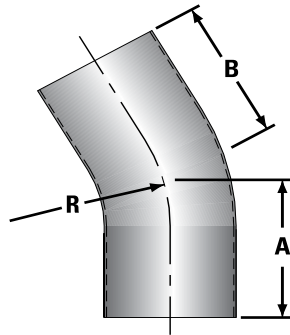

Diameter O.D.-O.D.		Leg Length (A & B)		Center Line Radius (R)		Part Number
in	mm	in	mm	in	mm	
3.50	89	4.00	102	5.00	127	J009635
4.00	102	4.00	102	5.00	127	J009636
5.00	127	4.00	102	5.50	140	J009637

30° O.D. - I.D.

- 16 gauge aluminized steel
- One end O.D., one end I.D. slotted

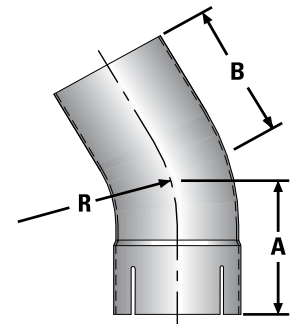

Diameter O.D.-I.D.		Leg Length (A & B)		Center Line Radius (R)		Part Number
in	mm	in	mm	in	mm	
3.50	89	4.00	102	5.00	127	J009631
4.00	102	4.00	102	5.00	127	J009632
5.00	127	4.00	102	5.50	140	J009633

15° O.D. - O.D.

- 16 gauge aluminized steel
- For use where clearance is a problem

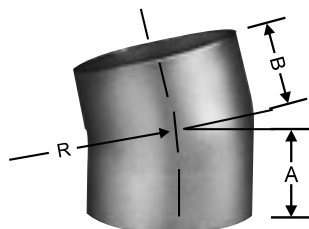

Diameter O.D.-O.D.		Leg Length (A & B)		Center Line Radius (R)		Part Number
in	mm	in	mm	in	mm	
3.00	76	1.75	44	5.00	127	P206393
3.50	89	1.75	44	5.00	127	P206394
4.00	102	2.50	64	4.00	102	P206395
5.00	127	4.00	102	5.50	140	P206396

Straight Tubing - Exhaust & Intake

- 16 gauge, unless footnoted



Exhaust Straight Tubing -10 ft (3m) length

-- O.D. --		Aluminized	Stainless Steel
in	mm		
2.00	51	P206331	
2.50	64	P206333	
2.75	70	J000127	
3.00	76	P206334	P224685 ²
3.50	89	P206335	P235790 ²
4.00	102	P206336	P224686 ²
5.00	127	P206337	P224687 ¹
6.00	152	P206338	

1- 304 Stainless Steel
2- 409 Stainless Steel



Intake Straight Tubing -10 ft (3m) length

-- O.D. --		Aluminum for Intake
in	mm	
3.00	76	P224684
4.00	102	P207367
5.00	127	P206849
5.50	140	P207368
6.00	152	P206850
7.00	178	P206851
8.00	203	P207369

Dump Truck Stack Pipes

- 16 gauge aluminized steel

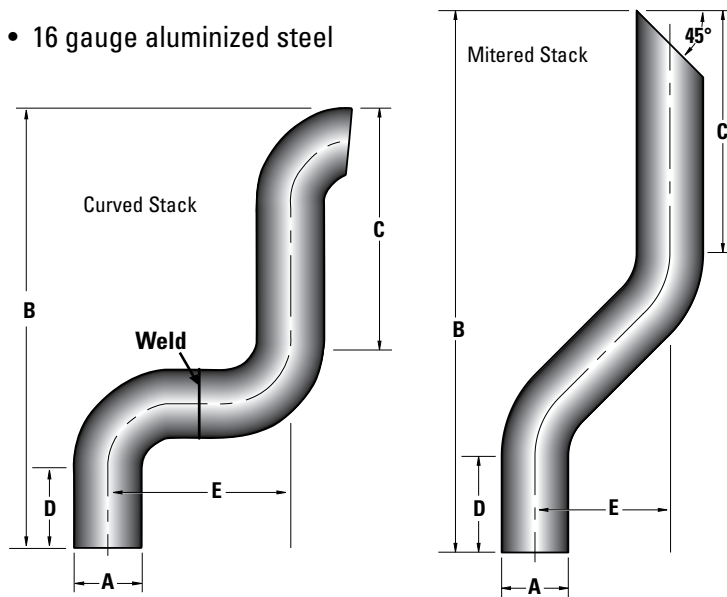

Dump Truck Stack Pipes

- O.D. Dia. - (A)		Overall Length (B)		Leg Length (C)		Leg Length (D)		-- Offset -- (E)		Curved Aluminized	Mitered Chrome
in	mm	in	mm	in	mm	in	mm	in	mm		
4.00	102	38.00	965	19.50	495	10.50	267	12.10	307	P224581	
		51.00	1295	32.28	820	7.67	195	8.20	208		P224692
5.00	127	38.00	965	18.00	457	9.00	229	12.10	307	P224582	
		51.00	1295	31.70	805	7.11	181	7.04	179		P224693

Super Stack

- Aluminized
- Packing inside stack will reduce exhaust noise by 2 to 3 dBA
- Mounts directly into existing system replacing the conventional stack

Part Number: M001327

O.D. Dia.		Length	
in	mm	in	mm
5.00	127	35.50	902



Straight Stack Pipes

- Keeps exhaust smoke and fumes from damaging cargos or blackening van bodies
- 16 gauge aluminized steel or chrome

ACCESSORIES

O.D. Style - Straight Stacks



O.D. Dia.	-- Length --			Aluminized	Chrome
		in	mm		
3.00	76	24.00	610	P208328	
		48.00	1219	P206376	
3.50	89	24.00	610	P208336	
		48.00	1219	P206377	
4.00	102	18.00	457		P208385
		24.00	610	J240012	
		48.00	1219	P206378	P206388
		60.00	1524	J640001	P206390
5.00	127	24.00	610	P224589	P224590
		48.00	1219	P206379	P206389
		60.00	1524	P208393	P206391

I.D. Style - Straight Stacks



I.D. Dia.	-- Length --			Aluminized	Chrome
		in	mm		
3.00	76	24.00	610	P216191	
		36.00	914	P208324	
		48.00	1219	P207285	P207314
3.50	89	18.00	457	P207281	
		24.00	610	J024735	
		36.00	914	P208348	
		48.00	1219	P207286	
4.00	102	18.00	457	P207282	
		24.00	610	J024737	P224627
		36.00	914	P208364	P224628
		48.00	1219	P207287	
		60.00	1524	P207288	P207299
		18.00	457	P207283	
5.00	127	24.00	610	J024739	J240024
		36.00	914	P208380	J340023
		48.00	1219	P207292	
		60.00	1524	P207289	P207300
6.00	152	48.00	1219	P216197	

45° Mitered Chrome Stack Pipes

- Keeps exhaust smoke and fumes from damaging cargos or blackening van bodies
- 16 gauge

O.D. Style - 45° Mitered Stacks



O.D. Dia.	-- Length --			Chrome
		in	mm	
4.00	102	18.00	457	P224696
		36.00	914	P224698
		48.00	1219	P224701
5.00	127	18.00	457	P224703
		36.00	914	P216227
		48.00	1219	P216228
		60.00	1524	J540008
		72.00	1829	P224609

I.D. Style - 45° Mitered Stacks



- I.D. Dia. -	-- Length --			Chrome
		in	mm	
4.00	102	18.00	457	P224604
		36.00	914	P224699
		48.00	1219	P224605
5.00	127	18.00	457	P224607
		36.00	914	P224614
		48.00	1219	P224616
		60.00	1524	P224608
		72.00	1829	P224706
		84.00	2134	P224611
		96.00	2438	P224707

Curved & Long 90° Stack Pipes

- Keeps exhaust smoke and fumes from damaging cargos or blackening van bodies
- 16 gauge aluminized steel or chrome

O.D. Style - Curved Stacks



O.D. Dia. in	mm	Length		Curved	
		in	mm	Aluminized	Chrome
3.00	76	24.00	610	P208330	J240016
		48.00	1219	P206380	P207312
3.50	89	24.00	610	P208338	
		48.00	1219	P206381	
4.00	102	24.00	610	J024748	J024749
		36.00	914	P208358	P208359
		48.00	1219	P206382	P206386
		60.00	1524	P208388	P208389
		72.00	1829		J640005
		96.00	2438		P209913
5.00	127	24.00	610	J024750	J024751
		36.00	914	P208374	P208375
		48.00	1219	P206383	P206387
		60.00	1524	P208394	P208395
		72.00	1829		P224600
		96.00	2438		P209912

I.D. Style - Curved Stacks



I.D. Dia. in	mm	Length		Curved	
		in	mm	Aluminized	Chrome
3.00	76	36.00	914	P208326	
		48.00	1219	P207293	P207318
3.50	89	24.00	610	P224633	
		36.00	914	P208350	P216200
		48.00	1219		P207319
4.00	102	24.00	610	J024746	J024757
		36.00	914	P208366	J034746
		48.00	1219	P207295	P207320
		60.00	1524	P207290	P207301
		72.00	1829		P216202
		84.00	2134		P224635
		96.00	2438		P224636
		5.00	127	24.00	610
6.00	152	36.00	914	P208382	P216204
		48.00	1219	P207296	P207321
		60.00	1524	P224709	P207302
		72.00	1829		P216205
		84.00	2134		P224638
		96.00	2438		P209910

I.D. Style - Long 90°



I.D. Dia. in	mm	Length		Aluminized	Chrome
		in	mm		
4.00	102	60.00	1524	P224710	P224641
5.00	127	60.00	1524	P224711	

Tailpipes - O.D. & I.D. Styles

Tailpipes O.D. & I.D. Styles



I.D. Style



O.D. Style

Dia. in	mm	Length		O.D. Style		I.D. Style	
		in	mm	Aluminized	Chrome	Aluminized	Chrome
2.00	51	9.00	229	P206306		P207415	
2.50	64	12.00	305	P206308		P206301	
2.75	70	12.00	305			P206927	
3.00	76	12.00	305	P206309		P206302	J014621
3.50	89	12.00	305	P206310		P206303	J014622
4.00	102	12.00	305	P206311		P206304	J014623
		18.00	457	P208386	P206384	P207297	P207308
5.00	127	12.00	305			P224617	P224618
		18.00	457	P208392	P206385	P207298	P207309
		20.00	508	P206312		P206305	
6.00	152	20.00	508	P207419		P207559	

Spark Arrestors

- U.S. Forest Service approved (80% efficiency on incendiary sparks)
- Reduces fire hazard
- Centrifugal force separates solids from exhaust gas
- Aluminized steel with stainless steel critical parts
- Can be installed vertically or horizontally (If possible, the clean out should face away from all fuel tanks, the vehicle operator's position and the air cleaner inlet.)



Selecting a Spark Arrestor

Generally, if a spark arrestor will fit on the exhaust pipe of an engine, it will also have acceptable backpressure for that engine. In some cases, a larger size spark arrestor will be required to stay within backpressure limits, and in those cases adapters will have to be used.

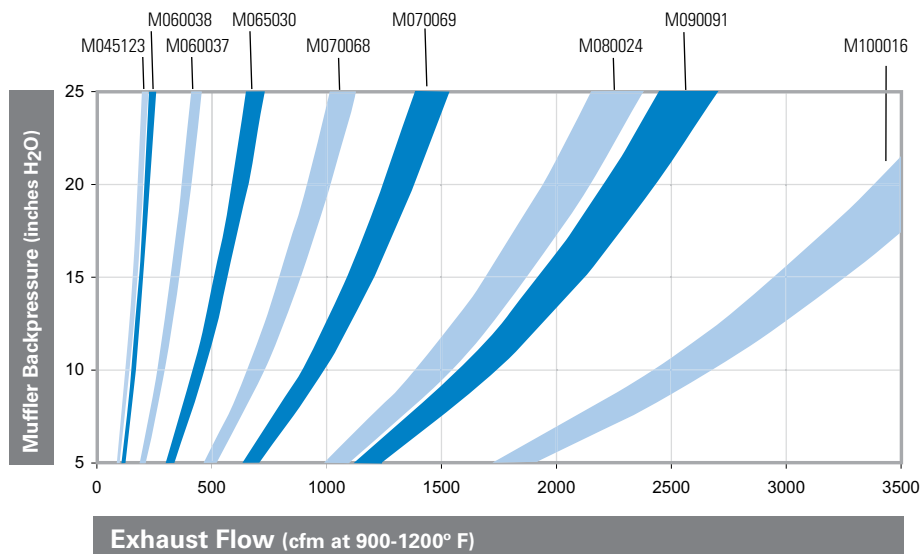

Spark Arrestor Service Tip

The spark arrestor should be inspected and cleaned out every 1,000 operating hours or three times per season. Visually inspect for holes, cracks and metal corrosion. Check the mounting clamp to make sure the spark arrestor is securely mounted. Replace the spark arrestor if your inspection reveals any of the above unsafe conditions.

Inlet I.D.		Outlet I.D.		Body Dia.		Body Length		Overall Length		Part Number
in	mm	in	mm	in	mm	in	mm	in	mm	
1.50	38	1.25 ¹	32	4.38	111	4.75	121	8.38	213	M045123
		1.50	38	6.00	152	3.75	95	9.36	241	M060038
2.00	51	2.00	51	6.00	152	5.00	127	11.10	283	M060037
2.50	64	2.50	64	6.61	168	6.25	159	13.00	330	M065030
3.00	76	3.00	76	7.00	178	7.56	194	14.63	372	M070068
3.50	89	3.50	89	7.00	178	9.00	229	16.50	419	M070069
4.00	102	4.00	102	8.00	203	10.63	270	18.19	461	M080024
5.00	127	5.00	127	9.00	229	11.75	298	20.75	527	M090091
6.00	152	6.00	152	10.00	254	13.38	340	23.50	597	M100016

1 - 1.25" is an outer diameter, not inner diameter.

Resonators

- Provides an additional 2 to 3 dBA exhaust noise reduction
- Installs in the exhaust system
- Straight-through design does not increase backpressure
- Aluminized steel
- Both ends I.D. slotted
- Common dimensions for both models:
 - Body Dia. 9" (229 mm)
 - Body Length 10" (254 mm)
 - Overall Length 16.5" (419 mm)



5" (125mm) I.D. and O.D. - Part No. M090072
 4" (102 mm) I.D. and O.D. - Part No. M090362

Muffler Guards

- Bright stainless shipped with protective film on one side
- Order clamps separately, unless noted otherwise

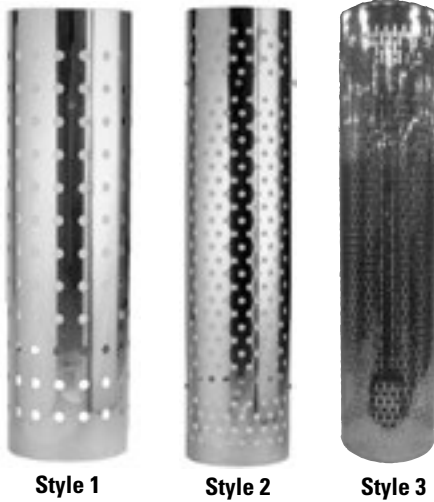

Muffler Guards

-- Muffler Diameter --		Style	-- Length --		Wrap	Bright	409
in	mm		in	mm		Stainless	Stainless
8.50 - 9.00	216-229	2	51.00	1295	180°	P206540	
8.50 - 10.00	216-254	1	45.00	1143	270°	X005207 ¹	
		2	51.00	1295	180°	J009429	
10.00-10.50	254-267	2	51.00	1295	180°	P206542	
11-00-11.50	279-292	3	34.00	863	180°		P230761
13.00-13.50	330-343	3	34.00	863	180°		P230762

1 - Includes two (2) clamps

Muffler Guard Clamps

- Two clamps required for installation
- Chrome plated (except * are zinc plated)



Muffler Guard Clamps

Muffler Dia.	Part	
in	mm	Number
8.50	216	P206510
9.00	229	P206511
10.00	254	P206512
11.00	281	P233422*
13.00	332	P233421*

Muffler Hangers

- For vertical and horizontal installations
- 11 gauge steel construction
- 12" overall bar length
- 3/8" - 16 UNC bolts/nuts included

Muffler Hangers

-- Muffler Dia. --	Part	
in	mm	Number
6.00	152	P206515
7.00	178	P206516
8.50	216	P206517
9.00	229	P206518
10.00	254	P206519
8.25x11.50	210x292	P206520
10.00x15.00	254x381	P206521
11.00	279	P224841



Heavy Duty Muffler Mounting Straps

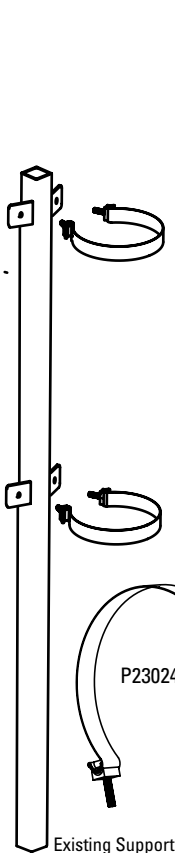

Existing Bracket

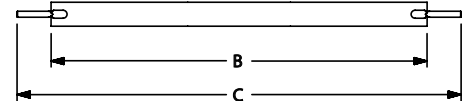
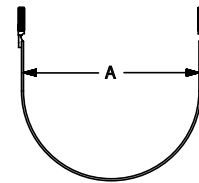
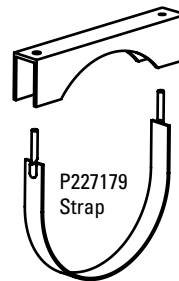

- Works with RE Bluebird buses with Cummins or Cat Engines

--- A ---	--- B ---	--- C ---	Part			
in	mm	in	mm	Number		
11.00	279	23.50	597	27.75	705	P227179

- Works with vertical mount Mack trucks when converting to a 10" diameter muffler.

--- A ---	--- B ---	--- C ---	Part			
in	mm	in	mm	in	mm	Number
10.00	256	20.00	508	23.50	597	P230241

Features and Benefits of Donaldson Mufflers

Low Backpressure

Better fuel economy and efficient engine performance

Aluminized Steel

Delivers long service life and is corrosion resistant

Lightweight Construction

Minimizes stress and vibration on mounting system

High Temperature Paint

Available on select product. Paint adds corrosion resistance and enhanced finish



Donaldson Mufflers

Donaldson exhaust systems are original equipment on most pre-2007 medium- and heavy-duty trucks manufactured in North America. Donaldson engineers work with many OE truck and off-road equipment manufacturers to design and build quality exhaust systems based on the specific performance.

Truck Mufflers for Every Budget

BEST (Part No. M101158 & M101181)



- 1 million mile warranty on M101158 – stainless steel Silent Partner™
- 500,000 mile warranty on M101181 – aluminized steel Silent Partner
- Superior acoustic performance – specifically addresses engine brake noise by silencing engine brake “bark”

BETTER (Part No. M100580)



- M100580 Donaldson muffler
- Meets all OEM back pressure, strength and life requirements
- Exhaust noise level is 4.5 - 7.5 dB(A) quieter than M100465 muffler

GOOD (Part No. M100465)

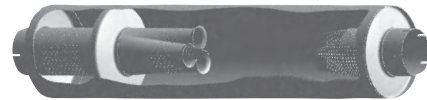

- The M100465 is the most common, most popular service muffler in the industry
- Low back pressure provides good fuel economy and efficient engine performance

What external characteristics differentiate mufflers?

- Shape of muffler (generally round or oval)
- Style (inlet/outlet configurations on the muffler)
- Materials

What internal characteristics differentiate mufflers?

- Wrapped (with insulation) or unwrapped
- Insulation sandwiched between an inner and an outer body
 - Reduces noise/high frequency
 - Lowers outer shell temperature
 - Reduces radiated heat
- Quantity, size, and position of internal baffles and tubes

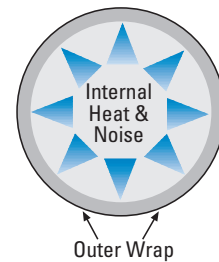

Exhaust System Configurations

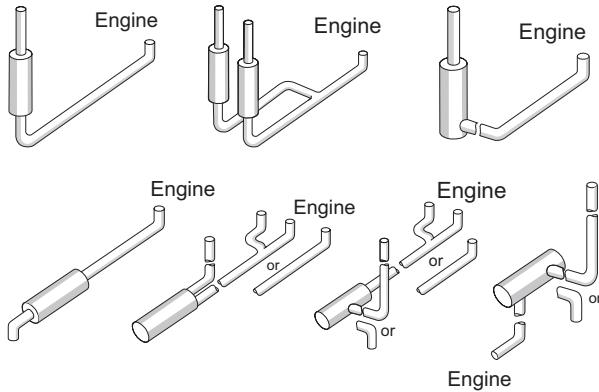

Exhaust Product Materials

A number of different materials are found in exhaust systems. Often different options are available for use in a single application. Since materials vary in strength, corrosion resistance, and price, a particular material may be preferred in individual applications and components. Some of the most common materials, their qualities, and their typical uses are listed in the following table.

Muffler Styles

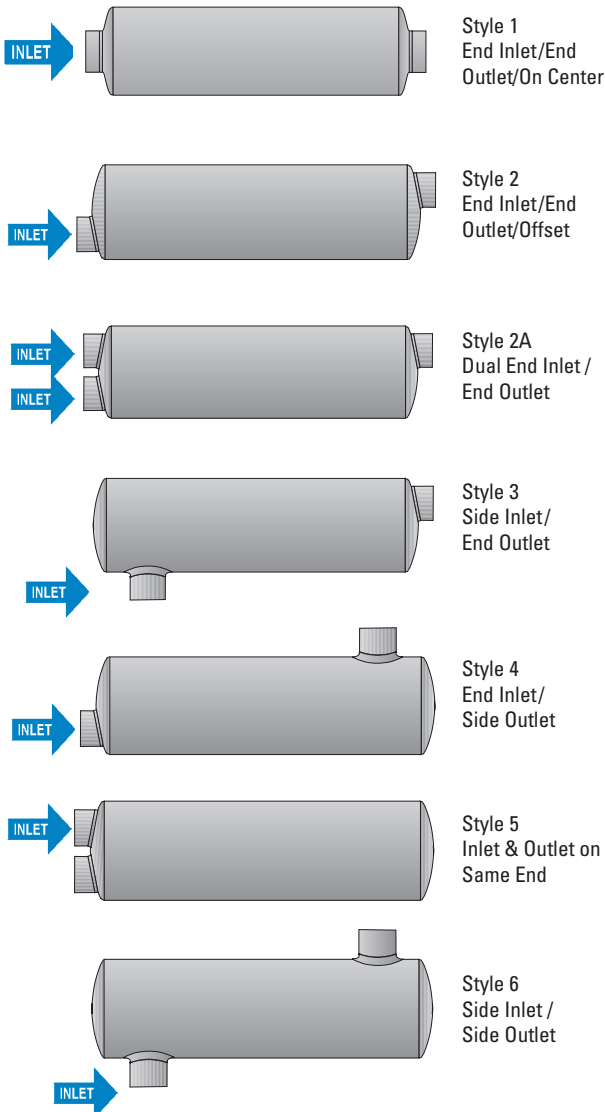

Materials*	Used in	Qualities
Aluminized Mild Steel	Mufflers	Good Corrosion Resistance
	Exhaust Components	
Stainless Steel (with and without aluminized coating)	Flexible Tubing	Stronger Excellent Corrosion Resistance
	Mufflers	
	Exhaust components	
	Emissions Products	
Chrome	Accessories	Bright Mirror Finish
Galvanized	Flexible Tubing	Low Material Cost Temperature Limit 600°F
Cold Rolled	Accessories	Poor Corrosion Resistance Low Cost

* See pg 163 for more further descriptions of materials used by Donaldson in exhaust system products.

New & Expanded Catalog Content

This edition of the Donaldson exhaust catalog includes the following additional information:

OVERVIEW



NEW

New Heavy-Duty Accessories

Newer and/or retrofit emissions systems weigh considerably more than the traditional OE exhaust system and require new mounting hardware to accommodate the extra weight. Our more popular heavy-duty brackets and clamps have been added.

Muffler Dimensions

& Specs

The estimated sound reduction (attenuation range in dbA) for all Donaldson mufflers has been added to the muffler selection tables starting page 55. We have also expanded the dimensional section by muffler style to include all muffler dimensions and muffler illustrations.

Muffler Sound Reduction

Cross Reference

Compared to our previous publication, this section include hundreds of new cross references. We do encourage you to use the Donaldson on-line cross reference for the latest information.

Shoptalk Section

Shoptalk is all about sharing helpful information to become more informed about Donaldson exhaust products and systems. This section includes installation tips for and fact sheets for many exhaust/emissions products and technologies.

Confused About Which Exhaust Clamp To Select or What Clamp Should be Used?

Depending on your exhaust joint and what you're connecting to, it's not always so easy to determine which one of our exhaust clamps is best for your needs.

Take a look at this new information on page 12 of our accessories section the next time you need a replacement clamp.



Where To Buy Donaldson Products?

Donaldson products are available through a variety of distribution outlets: OE dealers, independent warehouse distributors and exhaust-only distributors. Each of these distribution channels have their unique methods of servicing your needs to meet your business requirements.

To find the closest outlet in your region, visit www.donaldson-filters.com. Look in the Where to Buy section of our web site.

From Silencing to Emissions Reduction

1950s

When exhaust was about silencing -- we led the way! Frank Donaldson sold enough mufflers in 1951 to open our first exhaust manufacturing facility in Grinnell, Iowa in 1952.

1960s

In the 1960s, sound meters were used to measure noise levels (see image on right). Donaldson is one of the first manufacturers to introduce the use of aluminized steel in exhaust systems.



1970s

Donaldson introduces mufflers with integrated ejectors and wrapped mufflers. Wrapped mufflers reduced the overall exhaust system noise and the exterior body temperature. Donaldson SealClamp™ band-style exhaust clamp launched into the marketplace. Donaldson expands to Japan. In 1973, U.S. noise regulations went into effect for on-road vehicles – Donaldson offers a muffler line that was effective at noise reduction without loss of horsepower.



1980s

In 1981, Donaldson opens a new technical center. The center included two anechoic chambers which expanded our technical capabilities. Mufflers meet 1988 U.S. EPA truck noise regulations (sonic chokes and floating baffles).

1990s

When engine manufacturers needed help to meet the first U.S. Emissions regulations, innovations continued. In the early 1990s, we pioneered the design of integrated catalytic converter mufflers and diesel particulate solutions for three major U.S. engine and truck manufacturers. In the late 1990s, Silent Partner™ was the first muffler that effectively reduced engine brake noise without loss of power or fuel economy. During this decade, Donaldson expands exhaust manufacturing in Europe (France); Mexico (Guadalajara); and the United States (Alabama).

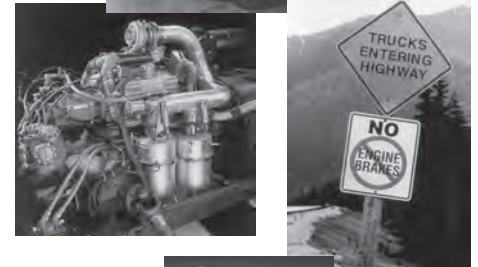

2000s

2001 Donaldson forms a group dedicated to emissions reduction efforts for diesel engines; begins retrofit projects; Spiracle™ crankcase filtration introduced to eliminate emissions from open crankcase vents. Mass production of CCMs for on-road OEs begins.



Since the early 1990s, Donaldson has sold more than a million DOC Mufflers.

2002 First of many CARB and EPA verifications for Donaldson retrofit emissions solutions; first company to verify tailpipe and crankcase solution (patented).

2003 Donaldson expands exhaust manufacturing in Aguascalientes, Mexico.

2004 Donaldson upgrades and expands heavy-duty engine test cell capabilities; U.S. MSHA accepts Donaldson high temp exhaust filter. New web-based Emissions Resource Center (www.donaldson.com/en/erc) established.

2005 DPF Cleaning System and DMF Muffler launched for emissions retrofit market. Donaldson introduces an active, smart DPF emissions solution for the most difficult duty cycles; low temperature, transient and extended idling.

2006 Donaldson expands European emissions staff and Mexico exhaust manufacturing to Monterrey; Donaldson improves Stepped SealClamp™.

2007 Donaldson expands OE emissions support with production of active and passive exhaust aftertreatment systems to meet U.S. EPA 2007 on-road emissions regulations.

2009 Donaldson produces urea and non-urea based NOx reduction systems for OE 2010 and retrofit for in-use vehicles.

Acronym Reference: See Shoptalk Section

Diesel Retrofit Emissions Solutions

www.donaldson.com/emissions



Governmental regulations across the globe are being implemented that reduce diesel emissions. These regulations affect both OE manufacturers and end users. Donaldson works with both OE manufacturers and fleets to design innovative, customized solutions. (See Shoptalk section for Diesel PM limits and global emissions regulations.)

In order to meet retrofit emissions regulations, diesel-powered vehicle owners around the world will be faced with major business decisions to become compliant with current regulations; choices include retrofit, refuel, rebuild, repower or replace.

For older vehicles that have five or more years of useful life available, fleet owners are electing to retrofit their vehicles to extend the life of their current equipment.

Donaldson takes a "total system approach" to retrofit – delivering patented solutions that reduce not just what comes out of your tailpipe, we also offer a solution that eliminates emissions generated from the engine crankcase (Spiracle™ crankcase filtration technology).

Donaldson has California ARB and U.S. EPA-verified solutions, an installation service network, and local Donaldson representatives that are ready to help you select the best solution for your fleet.

Do you have questions about meeting retrofit emissions regulations?

We have a specialized team of emissions experts that can help determine your emission reduction targets and then specify the right Donaldson solution, keeping in mind regulations, budgets and fleet size.

Emission Retrofit Sales Group

Email: emissionssales@donaldson.com

Phone: 866-675-2847

Web site: www.donaldson.com/emissions

Choices for Diesel Retrofit

Retrofit – new emission control devices on existing engines (filters, catalysts)

Refuel – cleaner diesel fuel (ULSD), emulsions or additives

Rebuild – repair/upgrade key components or engine reprogramming

Repower – put new or newer engine in existing equipment or chassis

Replace – vehicle/equipment condition less than the value of new engine

Internet Resource:

Emissions Resource Center

www.donaldson.com/en/erc

Emissions Retrofit Products

Retrofit solutions include cost-effective and high efficiency tailpipe and Spiracle™ crankcase filtration technologies plus our DPF cleaning system (DPF pulse cleaner and DPF Thermal Regenerator).

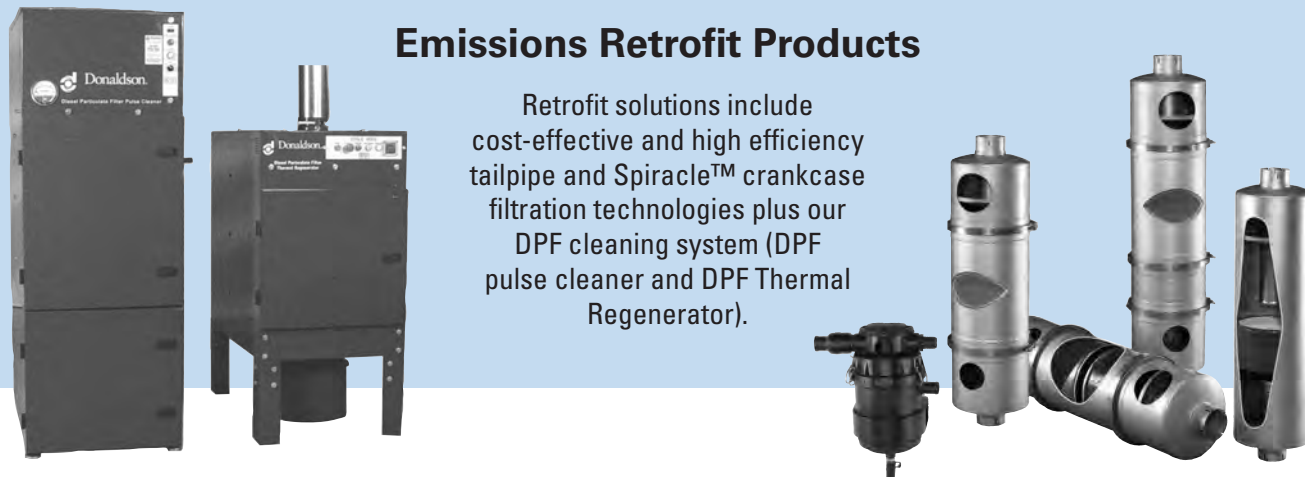

The calculations on the right are provided as a reference and may be helpful as you validate and select Donaldson mufflers and components.

For the most accurate engine airflow and exhaust flow rates, Donaldson recommends using the information supplied by your engine manufacturer.

Looking for Engine Exhaust Flow Guide?

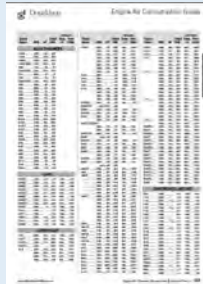

See Exhaust Flow Reference Section of this catalog.



Airflow guide should only be used as a reference document/ For proper muffler application, look to your engine supplier for the most accurate and current information.

Engine Exhaust Flow Rate Calculation

Exhaust flow rate may be calculated using the following formula. Exhaust temperature and intake airflow rate must be determined to calculate the exhaust flow rate. Exhaust temperature and manufacturers maximum backpressure may be approximated using the chart on the right.

$$\left(\frac{\text{Exhaust Temp. (°F)} + 460}{540} \right) \times \text{Intake Airflow (CFM)} = \text{Exhaust Flow (CFM)}$$

Engine Type	Engine Temperature	Maximum Backpressure
Diesel 2-Cycle Naturally Aspirated	= 900° F	4" Hg
Diesel 2-Cycle Turbo	= 750° F	3" Hg
Diesel 4-Cycle Naturally Aspirated	= 1000° F	3" Hg
Diesel 4-Cycle Turbo	= 900° F	3" Hg
Gasoline (all types)	= 1200° F	>4" Hg

Note: If you are spec'ing a dual muffler system, remember to divide engine's exhaust flow (CFM) by two

Engine Airflow Calculation

CFM intake rate is available from the engine manufacturer. If CFM specifications are not available, use the volumetric efficiency calculation. A simple calculation for cfm is to multiple the horsepower of your engine by 2.5.

4-Cycle Engine Airflow Calculation

$$\left(\frac{\text{Engine Size (CID)} \times \text{RPM}}{3456} \right) \times \text{Volumetric Efficiency} = \text{Intake Airflow (CFM)}$$

2-Cycle Engine Airflow Calculation

$$\left(\frac{\text{Engine Size (CID)} \times \text{RPM}}{1728} \right) \times \text{Volumetric Efficiency} = \text{Intake Airflow (CFM)}$$

Volumetric Efficiency

Engine volumetric efficiency ratings are best obtained from your engine manufacturer. Engines operating with electronic controls could have volumetric efficiency ratings of more than 2.0. Airflow on these engines should be verified by the engine manufacturer.

4 Cycle GAS Engine	Naturally Aspirated	= .70 - .80
2 and 4 Cycle DIESEL Engine	Naturally Aspirated	= .90
	Turbo*	= 1.50 - 3.00*

* If VE rating is not available, Donaldson recommends using the highest value to insure proper airflow.

The information below is the exhaust portion of our Engine Aftermarket Filtration & Exhaust Warranty Document: F110064 (February 2006)

OVERVIEW

Donaldson warrants its Aftermarket products against failure due to defects in materials and workmanship for the period specified under Terms and Conditions for the particular product. Donaldson’s obligation under this warranty covers replacing the failed product, including transportation charges, only. If the Donaldson product failure is the sole and direct cause of damage to the equipment on which the product was properly installed, Donaldson will reimburse reasonable costs to restore the equipment to the condition it was in immediately before the failure. This warranty does not cover failure due to misapplication, misuse, abuse, neglect, rust through and corrosion (mufflers), improper service practices or non-Donaldson approved modifications. Engine and equipment manufacturers warranties remain in effect when Donaldson products are used.

Donaldson must be notified in writing of any claims covered by this warranty within one year of the date of failure. Donaldson, at its discretion, will either physically visit the site where the alleged failure has been found; or, request that all parts, Donaldson and other relevant parts, be shipped prepaid to its General Office, in care of the Product Lab or as otherwise specified.

Terms & Conditions

Warranty coverage begins on the date and mileage the product is purchased by the user and expires when the specified number of years or miles has passed, whichever occurs first.

The length of warranty for replacement products provided under warranty coverage is the balance of the warranty period remaining on the product being replaced.

Warranty Length by Product

Exhaust Products	Warranty from Date of Delivery to User
Diesel Mufflers	
Vertical Installation	4 Years or 500,000 miles (800,000 km)
Horizontal Installation	3 Years or 500,000 miles (800,000 km)
Gas Mufflers	1 Year
Silent Partner™, Exhaust Silencer	
Stainless Steel	8 Years or 1,000,000 miles (1,600,000 km)
Aluminized Steel	4 Years or 500,000 miles (800,000 km)
Exhaust Accessories	1 Year
Chrome Parts	1 Year or 100,000 miles (160,000 km) (peeling & blistering only)
Flex Pipe	90 Days
Long-Life Flex Pipe	1 Year or 120,000 mile (200,000 km) (on-highway vehicles only)

Horizontal Hangers for Round Mufflers

ACCESSORIES

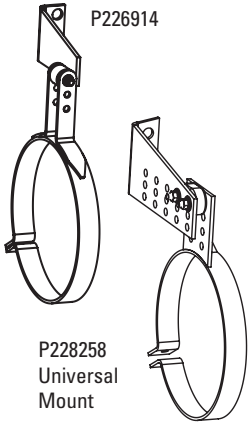

--- A ---		--- B ---		--- C ---		--- D ---		--- E ---		Part Number
in	mm	in	mm	in	mm	in	mm	in	mm	
10.00	256	9.31	236	5.75	146	1.75	44	.38	10	P227728
11.00	279	10.16	258	6.00	152	2.50	66	.75	19	P226914 ⁽⁴⁾
11.00	279	10.03	255	6.50	165	2.00	51	.56	14	P227167 ⁽⁵⁾
11.00	279	10.03	255	6.50	165	2.00	51	.56	14	P227175 ⁽⁶⁾
11.00	279	6.50-10.5	165-268	5.5-9.0	140-229	1.00/2.50	25/66	.50/.75	13/19	P228258 ⁽⁷⁾
13.00	330	6.50-10.5	165-268	5.5-9.0	140-229	1.00/2.50	25/66	.50/.75	13/19	P230046 ⁽⁷⁾

- 4. Works with International School bus when converting to round muffler
- 5. Works with conventional Thomas/Freightliner buses with Cat or Cummins engines
- 6. Works with conventional Thomas/Freightliner buses with Mercedes Benz engine up to 2003
- 7. Universal mount

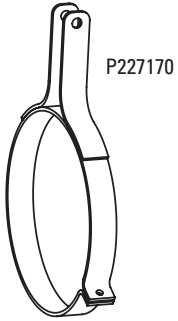
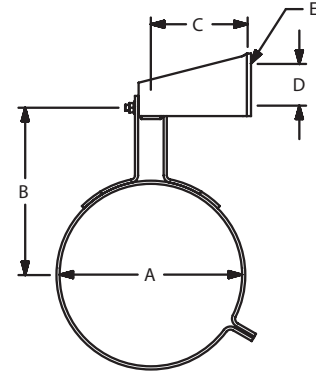

--- A ---		--- B ---		--- C ---		--- D ---		Part Number
in	mm	in	mm	in	mm	in	mm	
10.00	256	10.78	274	.56	14	1.31	33	P230284
11.00	279	10.78	274	.56	14	1.31	33	P227170 ⁽⁸⁾

- 8.. Works with 2004 Thomas Conventional with Mercedes Benz Engine

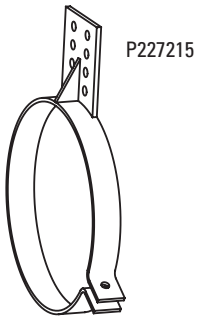
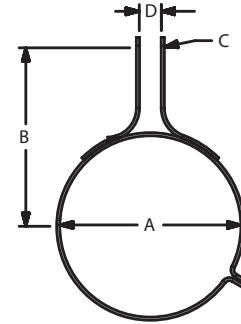

- Universal application

--- A ---		--- B ---		--- C ---		--- D ---		Part Number
in	mm	in	mm	in	mm	in	mm	
11.00	279	6.25 / 9.25	159 / 235	1.75	44	.50	13	P227215
13.00	330	7.25 / 10.25	184 / 262	1.75	44	.50	13	P230047

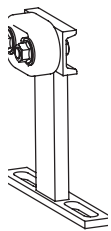
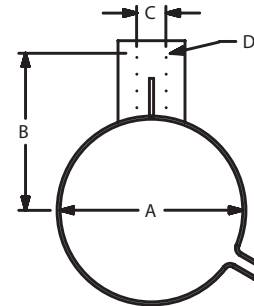

Part No. P227178

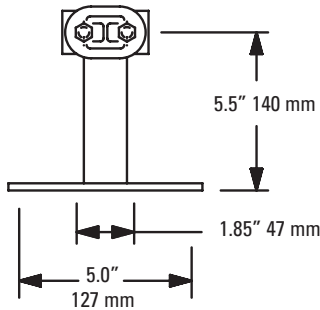

- Works great with u-bolt and w-foot body bands, and P228260 or P227839 hangers
- Black paint finish
- Used on Bluebird FE/FC Bus

Part No. P227805

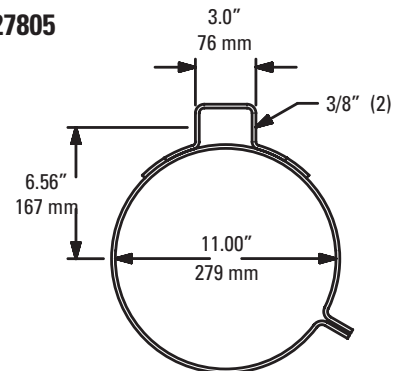

School Bus Hangers

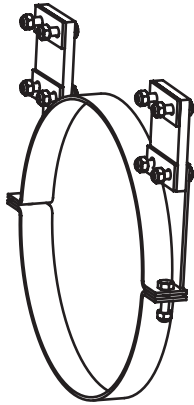

Part No. P227182

- Used for rear engine Thomas buses
- Horizontal mount
- All bolts shown are included

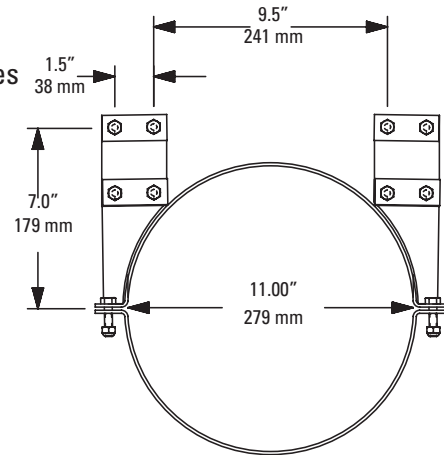

Horizontal Hanger for Oval Mufflers

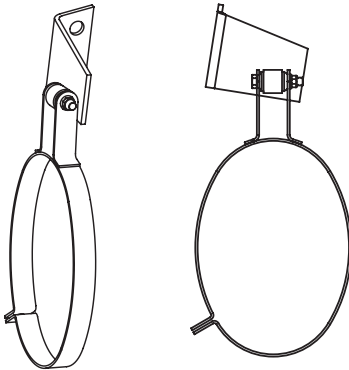

Part No. P229114

- Unique for Front Engine International School Bus with Oval DOC muffler
- Direct replacement to OE hanger
- Works with oval muffler diameter of 8.25" x 11.5"

Universal Horizontal Hangers

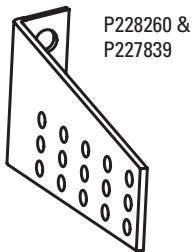

- Schools buses retrofits
- Corner mount with two bolts

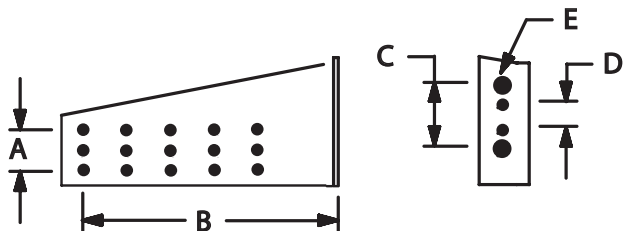

--- A ---		--- B ---		--- C ---		--- D ---		--- E ---		Part Number
in	mm	in	mm	in	mm	in	mm	in	mm	
1.30	33	5.31/9.94	135/252	2.50	64	1.26	32	.50	.13	P227839 ⁽³⁾
1.62	41	2.94/9.94	75/252	2.50	64	1.00	25	50/75	13/19	P228260

3. Bracket holes are .62" x .35" slots

Grab Handles

- For use with muffler and pipe guards
- Chrome plated

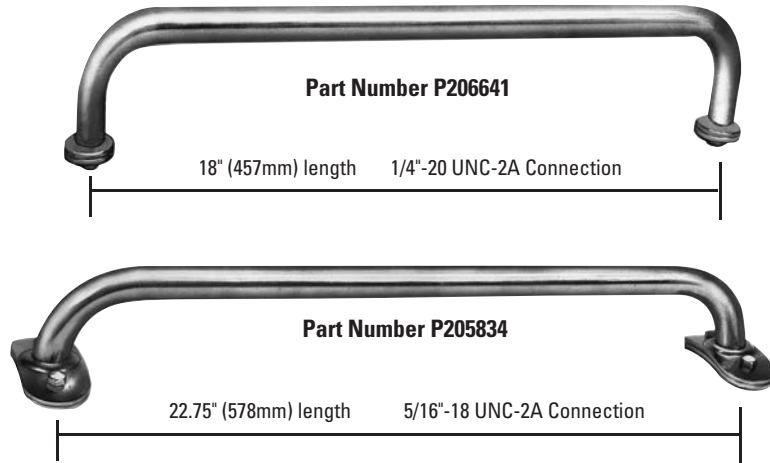

Manifold Tube

- For manifold connections
- Size: 4" (102 mm) O.D.
- Basic application: Cummins NH series engines
- 16 gauge cold rolled steel



Manifold Tube
Part Number
P206617

Manifold Flange

- 16 gauge cold rolled steel



Manifold Flange
Part Number P206616

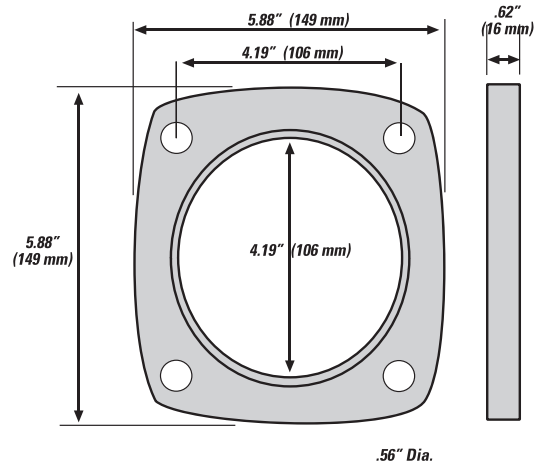

Threaded Adapter



--- O.D. ---	Thread (NPT)	Part
inch mm	inch mm	Number
3.00 76	3.00 76	J009514
3.50 89	3.50 89	J009516
4.00 102	4.00 102	J009518

NPT - National Pipe Thread

Exhaust Ejectors

Components For Scavenged Air Systems - Exhaust Ejectors & Check Valves

A Donaldson exhaust ejectors and check valves are a key components to create a scavenged or aspirated air system. The ejector is used with Donaldson Donaspin™ or Strata™ Cap pre-cleaners, Strata™ systems, or PowerCore® PSD air cleaners.

A scavenged air system is typically used in off-highway equipment to extend air filter life. The exhaust ejector mounts as a stack at the end of exhaust system. It is recommended that the stack be covered with a curved exhaust stack or rain cap.

The redesigned ejector line offers a shorter length tube than our original standard and expanded ID offerings. With less space to work with, the new offering may work in applications where the previous models did not fit.

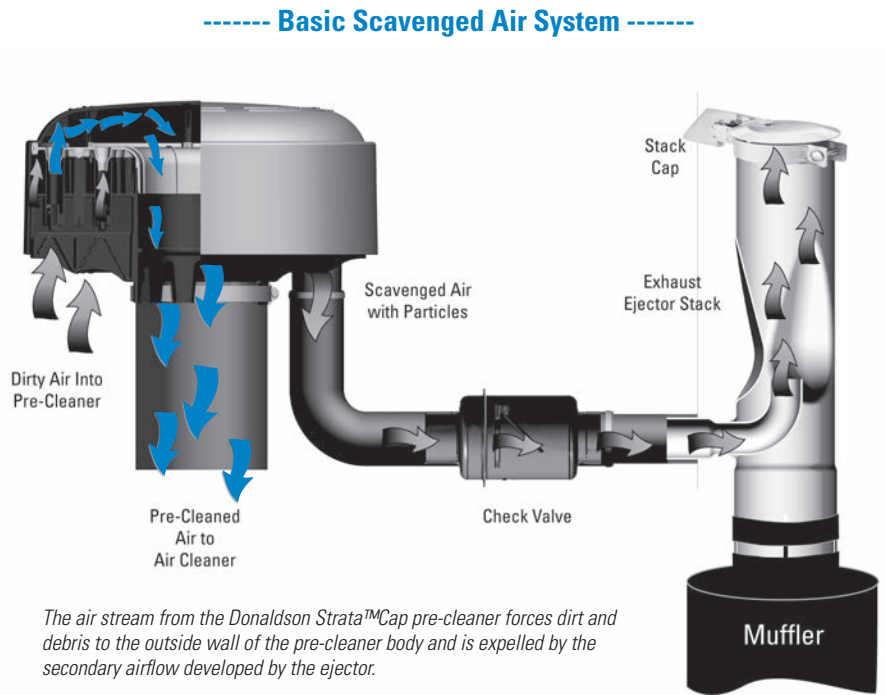

Exhaust Ejectors

- Can be used with any pre-cleaner that has scavenge tube connection.
- Adds only 4" (102 mm) to 8" (203 mm) H₂O (.3" to .6" Hg.) to exhaust backpressure
- Models all fit up to a muffer outlet tube outer diameter
- All models have a nominal OD outlet end for proper fit of stack caps and other accessories
- For proper structural support, muffer outlet tube length and stack engagement must be a minimum length of 1.5-2.0" / 38-51 mm
- Finish on all models is high temperature, black, semi-gloss finish

Compact Style

Part Number	Engine Intake CFM	-- Inlet I.D. --		Scavenge Tube O.D.		Ejector --- Length ---		Exhaust Flow Rate (CFM)	
		inch	mm	inch	mm	inch	mm	Min. ¹	Max. ²
H001278 ⁵	165-215	2.77	70	1.25	32	9.75	248	415	545
H001279 ⁵	300-390	3.02	77	1.25	32	10.80	274	760	990
H001284 ⁵	450-590	4.02	102	1.25	32	14.38	365	1140	1500

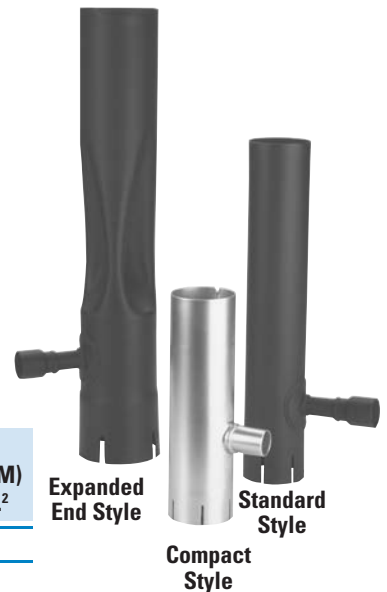

1 - Minimum exhaust flow based on 20" of water dead head vacuum
 2 - Maximum exhaust flow based on 40" of water dead head vacuum
 3 - Use 3-ply Silicone Scavenge Hose (1.50" I.D., 3 ft. length) P171378 and Lined Hose Clamp P115200
 4 - Use 3-ply Silicone Scavenge Hose (2.00" I.D., 3 ft. length) P171381 and Lined Hose Clamp P115200
 5 - Use 3-ply Silicone Scavenge Hose (1.25" I.D., 3 ft. length) P171376 and Lined Hose Clamp P532924

Exhaust Gas Temperature of 900° F assumed

Exhaust Ejectors & Check Valves

Exhaust Ejectors for Scavenged or Aspirated Air System

All exhaust ejectors are constructed heavy-gauge, aluminized steel, and painted with a high-temperature black paint. Select the appropriate ejector by the intake airflow or exhaust flow (CFM) of your engine.



Engine Intake CFM		Exhaust CFM @ 900° F		Standard Ejectors			Expanded I.D. Ejectors			Length		Scavenge Tube O.D.	
Low	High	Low	High	Inlet Dia.* inches	mm	Part Number	Inlet Dia.* inches	mm	Part Number	inches	mm	inches	mm
220	365	554	919	3.02	77.0	H002612	3.16	80.3	H002762	12.00	304.8	1.25	32
315	450	793	1133	4.02	102.0	H002613	4.17	105.9	H002763	18.00	457.2	1.25	32
425	600	1070	1511	4.02	102.0	H002614	4.17	105.9	H002764	18.00	457.2	1.50	38
500	740	1259	1864	5.03	127.8	H002615	5.17	131.0	H002765	22.00	558.8	1.50	38
660	950	1662	2393	5.03	127.8	H002616	5.17	131.0	H002766	22.00	558.8	1.75	44
800	1150	2015	2896	6.04	153.4	H002617	6.19	157.0	H002767	24.00	609.6	2.00	51
950	1350	2393	3400	6.04	153.4	H002618	6.19	157.0	H002768	24.00	609.6	2.00	51
1100	1500	2770	3778	6.04	153.4	H002619	6.19	157.0	H002769	24.00	609.6	2.00	51

* This dimension only applies to 2.5" /64mm of length – not the full length of the ejector.

3 ft. / .91 m Silicone Scavenge Hose & Lined Hose Clamp for:

- 1.25" / 32 mm Scavenge Tube: Hose: P171376 and Lined Hose Clamp P532924
- 1.50" / 38 mm Scavenge Tube: Hose: P171378 and Lined Hose Clamp P115200
- 2.00" / 51 mm Scavenge Tube: Hose: P171381 and Lined Hose Clamp P115200

Ejector Check Valve Prevents Exhaust Backflow

The exhaust ejector check valve prevents backflow of damaging exhaust gases by way of an internal hinge flap. Add an ejector check valve when configuring the intake system to expel filtered contaminant through the exhaust system.

- Mounts horizontally (see installation diagrams)
- Durable, non-corrosive metal construction
- No servicing required

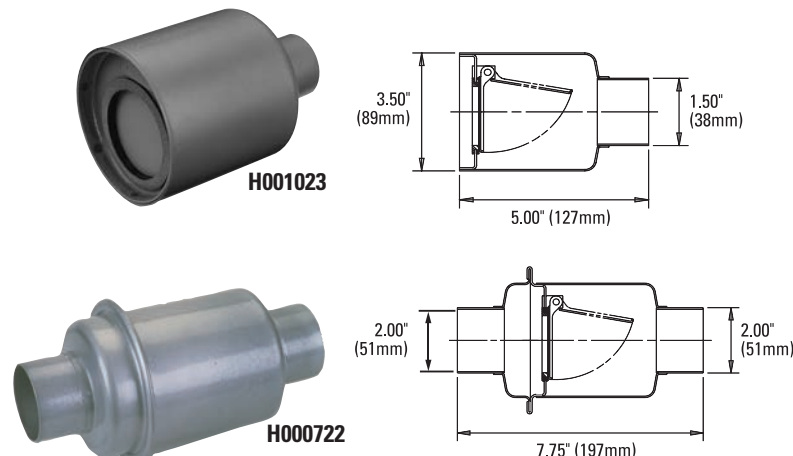

Check Valve Installation

The illustrations are side views of two-stage air cleaners, showing the position of the check valve. A 3" (76mm) inner diameter rubber reducing elbow or hump reducer is required for installation. See pages 94-96 for options.

Installation on F Series Cyclopac™

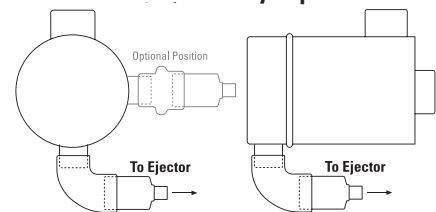

Installation on S Series Donaclone™

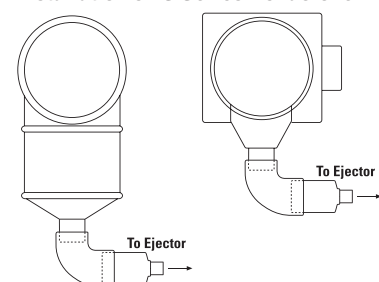

These flexible rubber adapters and elbows have smooth radii and inside surfaces to minimize flow resistance within the air intake system.

These rubber products are heavy-duty!

Larger elbows (5"/125mm) are ribbed or compounded for added strength and durability. All Donaldson rubber products meet ASTM standards.

- Resist tears, punctures and vacuum collapse

- Absorb vibration
- Reduce intake noise levels under severe conditions
- Material: EPDM rubber construction
- Temperature range: -40°F (-40°C) to +212°F (+100°C)
- Application tip: A minimum 1½" of metal piping should be inserted into the rubber fitting

90° Rubber Elbows & Reducing Elbows

90° Elbows

Inner Dia. (A)		Center Height (B)		Radius (R)		Part Number
in	mm	in	mm	in	mm	
2.00	51	3.50	76	2.00	51	P105529
2.25	57	3.75	95	2.25	57	P105530
2.50	64	4.00	102	2.50	64	P105531
3.00	76	5.25	133	3.75	95	P105532
3.50	89	5.50	140	4.00	102	P114318
4.00	102	5.75	146	4.50	114	P105533
4.50	114	5.50	140	3.50	89	P113733
5.00	127	6.12	155	4.50	114	P107844
5.50	140	6.50	171	4.63	118	P105534
6.00	152	7.00	179	5.00	127	P105535
7.00	179	7.56	192	5.56	141	P105536
8.00	203	8.50	216	6.50	165	P112605
10.00	254	10.50	267	8.50	216	P114314

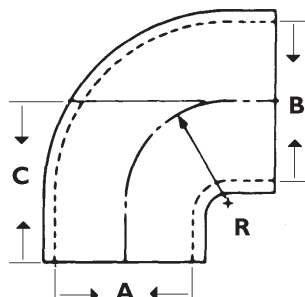

90° Elbow Reducers

Inner Dia. (A)		Inner Dia. (B)		Center Height (C)		Radius (R)		Part Number
in	mm	in	mm	in	mm	in	mm	
3.00	76	3.50	89	3.50	89	2.25	57	P123462
		4.00	102	4.50	114	3.00	76	P536163
4.00	102	5.00	127	6.00	152	3.75	95	P121482
		5.00	127	6.00	152	3.50	89	P537468
		6.00	152	6.00	152	4.25	108	P143895
5.00	127	7.00	179	6.25	159	4.25	108	P159820
		6.00	152	6.75	171	5.00	127	P117724
		7.00	179	6.25	159	4.38	111	P128990

45° Rubber Elbows, Reducing Elbows and Hump Reducers

ACCESSORIES



45° Elbows

Inner Dia. (A)		Radius (R)		Part Number
in	mm	in	mm	
2.00	51	2.00	51	P105541
2.25	57	2.25	57	P105542
2.50	64	2.50	64	P105543
3.00	76	3.75	95	P105544
3.50	89	3.50	89	P109331
4.00	102	4.25	108	P105545
4.50	114	3.50	89	P114316
5.00	127	4.50	114	P109021
5.50	140	4.75	121	P105546
6.00	152	5.00	127	P105547
7.00	178	5.56	141	P105548
8.00	203	6.50	165	P112606
10.00	254	8.50	216	P114313

45° Elbow Reducers

Inner Dia. (A)		Inner Dia. (B)		Center Height (C)		Radius (R)		Part Number
in	mm	in	mm	in	mm	in	mm	
5.50	140	6.00	152	6.44	164	4.88	124	P133338
6.00	152	7.00	179	7.38	187	5.31	135	P133339



Rubber Hump Reducers

Inner Dia. (A)		Inner Dia. (B)		Length (C)		Part Number
in	mm	in	mm	in	mm	
3.00	76	2.50	64	4.50	114	P102820
		2.75	70	3.50	89	P520883
3.50	87	3.00	76	5.00	127	P101290
		2.75	70	4.00	102	P520882
4.00	102	2.75	70	4.00	102	P520884
		3.00	76	5.25	133	P101291
		3.50	87	5.25	133	P101292
4.50	114	4.00	102	6.00	152	P540256
5.00	127	4.00	102	6.00	152	P101293
		4.50	114	6.25	159	P604045 ¹
5.50	140	4.00	102	6.00	152	P101891
		5.00	127	6.00	152	P103516
6.00	152	5.00	127	6.00	152	P112611
		5.50	140	6.00	152	P101294
		5.00	127	7.00	179	P136494
7.00	179	5.50	140	7.00	179	P126530
		6.00	152	6.00	152	P112610
		5.50	140	7.00	179	P129660
8.00	203	6.00	152	6.00	152	P114315
		7.00	179	6.00	152	P112609
		8.00	203	6.00	152	P112607

¹ - Use clamp size for nominal 5" (127mm) I.D. each end



Rubber Straight Humps

Inner Dia. (A)		Length (B)		Part Number
in	mm	in	mm	
3.00	76	5.30	135	P105608
3.50	89	5.25	133	P114319
4.00	102	5.25	133	P105609
4.50	114	6.00	152	P114317
5.00	127	6.00	152	P105610
5.50	140	6.00	152	P105611
6.00	152	7.00	165	P105612
7.00	179	7.00	165	P105613
8.00	203	5.00	127	P112608
10.00	254	6.00	152	P111414



Rubber Reducers

Inner Dia. (A)		Inner Dia. (B)		Length (C)		Part Number
in	mm	in	mm	in	mm	
2.00	51	1.50	38	2.50	64	P104087
		1.75	44			
2.25	57	2.00	51	2.50	64	P104088
2.50	64	2.00	51			
		2.25	57	2.50	64	P104090



90° Cobra Adapters

Inner Dia. (A)		Inner Dia. (C)		Length (B)		(D)		Part Number
in	mm	in	mm	in	mm	in	mm	
2.75	70	4.00	102	6.50	165	1.81	46	P600328
3.00	76	3.00	76	5.22	133	1.91	49	P547694
4.00	102	4.00	102	6.44	164	2.69	68	P600325
						3.19	81	P600326
						3.19	81	P600327

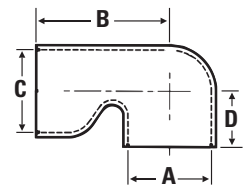

Silicone Charge Air Connectors

ACCESSORIES

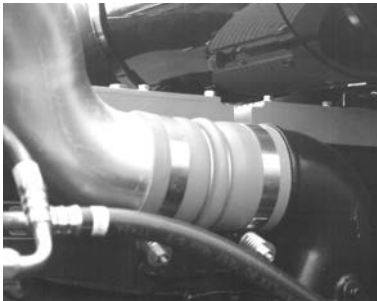

Our three styles of charge air connectors are designed to ease connections in air intake system piping: they compensate for slight misalignment and isolate vibration between hose connections. The silicone elastomer material resists chemicals, steam, ozone, coolants and aging conditions normally found in any engine operating environment.

All three charge air connectors are for installation on the pressure side with maximum operating temperatures up to 500°F (260°C.) They are orange in color to be easily identifiable as tolerant of high temperatures, and carry a one year warranty.



Connectors/Sleeves

Inner Dia. in	mm	Length in	mm	Part Number
2.00	51	36.00	914	P532948
2.25	57	36.00	914	P532949
2.50	64	36.00	914	P532950
3.00	76	36.00	914	P532951
3.38	86	3.50	89	P532952
		6.00	152	P532953
		36.00	914	P532954
3.50	89	3.50	89	P532956
		4.50	114	P532957
		36.00	914	P532958
4.00	102	36.00	914	P532959

Hump Hose Connectors

Inner Dia. in	mm	Length in	mm	Part Number
2.50	66	5.50	140	P532960
2.75	70	4.25	108	P532961
3.00	76	4.38	111	P532962

4-Ply Bellows

Inner Dia. in	mm	Length in	mm	No. of Rings	Part Number
3.50	89	6.00	152	3	P535572
4.00	102	6.00	152	0	P532943
		6.00	152	2	P535571
		6.00	152	3	P532944
		7.50	191	3	P532945
		8.00	203	3	P535573

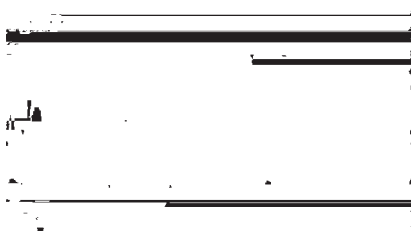

Use the illustration as a guide for installing your charge air connector. For proper installation, use Donaldson Constant Torque clamps to retain clamp load. Torque to 70-75 lbs-in.

Worm-Drive Hose Clamps

- Versatile clamps for wide size range of hose connections
- Made of strong, durable, noncorrosive stainless steel
- Inside of clamp is lined so that hose doesn't bulge through clamp holes
- Narrow band enables easy installation in confined areas



High Torque Clamp

--- Min. to Max. Size --- inch mm	Part Number
4-1/4 - 5-1/8 108-130	P115204
5-1/4 - 6-1/8 133-156	P115205
6-1/4 - 7-1/8 159-181	P115206
7-1/4 - 8-1/8 184-206	P115207
8-1/4 - 9-1/8 210-232	P115208
10-1/4 - 11-1/8 260-286	P115209

Recommended application up to 150 lbs-in torque

This EXTRA heavy-duty clamp ensures total protection against leakage...eliminates the need for double clamping.



Constant Torque Clamp

--- Min. to Max. Size --- inch mm	Part Number
2-1/4 - 3-1/8 57-79	P532925
2-3/4 - 3-5/8 70-92	P532926
3-1/4 - 4-1/8 83-105	P532927
3-3/4 - 4-5/8 95-117	P532928
4-1/4 - 5-1/8 108-130	P532929

Recommended application up to 90 lbs-in torque

Donaldson Constant Torque lined clamps are the best choice for systems where clamps cannot be retightened and have difficult access. Perfect for applications requiring higher torque, large diameters, temperature extremes, or where expansions and contractions within the system are common. This clamp is a good choice for critical coolant and charge-air connections.



Lined Hose Clamp

-- Min. to Max. Size -- inch mm	Part Number
9/16 - 13/16 14-21	P532919
11/16 - 15/16 17-24	P532920
13/16 - 1-1/16 21-27	P532921
13/16 - 1-1/2 21-38	P532923
13/16 - 1-3/4 21-44	P532924
15/16 - 1-1/4 29-32	P532922
1-9/16 - 2-1/2 40-62	P115200
2-1/16 - 3 52-76	P115201
2-13/16 - 3-3/4 71-95	P143422
3-5/16 - 4-1/4 84-108	P115202
4-5/16 - 5-1/4 109-133	P115203

Recommended application up to 40 lbs-in torque

Donaldson lined hose clamps seal silicone and other soft hoses without damage. The inner liner extends under the perforations to protect the hose and prevents extrusions through the worm-gear perforations.

T-Bolt Clamps



Nominal I.D. ¹	Min. to Max. Size inch	mm	Part Number
2.00	2.25-2.53	57-64	P148337
2.25	2.50-2.78	63-70	P148338
2.50	2.81-3.09	71-78	P148339
2.75	3.06-3.34	78-85	P148340
3.00	3.31-3.59	84-91	P148341
3.50	3.81-4.09	98-104	P148342
4.00	4.31-4.59	109-116	P148343
4.50	4.81-5.09	122-129	P148344
5.00	5.31-5.59	135-142	P148345
5.50	5.94-6.21	151-158	P148346
6.00	6.38-6.65	162-169	P148347
7.00	7.38-7.78	187-198	P148348
8.00	8.25-8.56	216-226	P148349
10.00	10.50-10.91	267-277	P148350

1 - Nominal I.D. dimension, shown in inches, corresponds to I.D. dimension of rubber part being clamped.

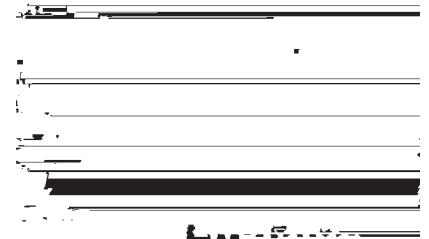

Initial torque on lined hose clamp should be 40 lbs-in. If retorquing is required, limit to 20 lbs-in.

Replacement Vacuator™ Valves

ACCESSORIES

The Vacuator Valve, standard on the majority of Donaldson air cleaners, is an important part of the functionality of the air cleaner. It is an integral part of the pre-cleaning stage on two-stage air cleaners.

The dust cup, where pre-cleaned dust is collected, is normally under a slight vacuum when the engine is running. The normal engine pulsing of the vacuum causes the Vacuator Valve to open and close. This action automatically expels any collected dust and water. The Vacuator Valve also unloads when the engine is stopped.



The Donaldson Vacuator Valve, also known as VacValve, is made in a variety of sizes and shapes to fit various applications. The Donaldson part number is molded into each part for easy identification.

Vacuator Valves

Part Number	Diameter in	Diameter mm	Durometer	Used on Air Cleaner Styles
P103198	3.0	76	40	FRG 10", 12", 14" and 16"; FHG 10", 12", 14" and 16"; FTG; FWA 5"-16"; FWG 4"-16"; SRG; In-line Water Separators
P105220	3.0	76	60	FRG 18"; FHG 8"; FVG160587
P106593	3.0	76	60	FHG 6"-8", High Pulsation Models
P112803	3.0	76	40	FHG 6"-8"; PSD 10", PSD 12"; SBG 14"-16"; SDG; STG 12"-16"
P149099	1.0	25	60	ERA; EBA; EBB; ECG
P158914	2.0	51	50	XRB, FKB; PSD 8"; PSD 9"; FPG 6" and 8"; FRG 5"-9", 11"; FHG 5", FWG; FWA; Moisture Skimmers
P522958	2.0	51	60	FPG 4" -5"; FHG
P525956	1.0	25	60	EPG 11", 13", 15"
P617632	1.57	40	50	PSD 08"
P776008	2.0	51	60	FPG 9", 10" Twist-off cover; FRG 10", 13", and 15"

Application Notes

For proper operation, the Vacuator Valve should be located at the lowest point on the air cleaner or dust cup pointing down.

Never paint the Vacuator Valve. Solvents and chemicals will shorten the usable life.

If the Vacuator Valve is torn, shredded or turned inside out, its durometer may be too soft for the application. Choose a model with a harder durometer (higher number). Conversely, if the Vacuator Valve doesn't empty itself properly, the durometer may be too hard. Choose one with a softer durometer (lower number.)

For the longest filter service life, replace damaged or missing Vacuator Valves immediately!

If your valve is cracked, torn, remains open or is missing, dust particles that are normally expelled can deposit themselves onto the filter and will shorten air filter service life. **Replace it!**

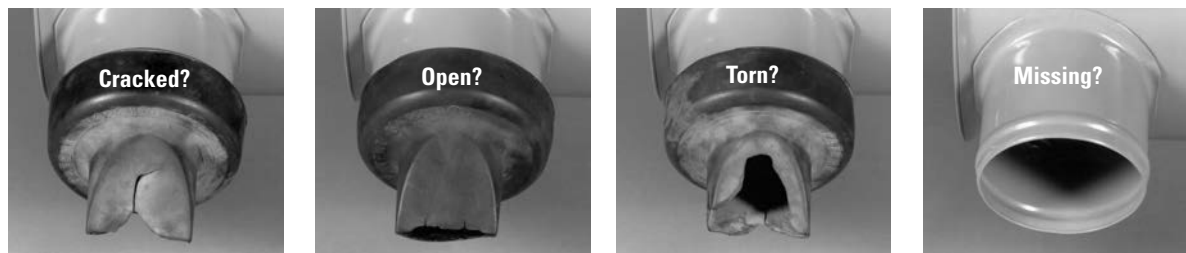

The Informer™ for Graduated, Continuous Readings



The Informer, when mounted on the air cleaner or the dashboard, provides a continuous reading whether the engine is running or is shut down. Reset button is on top. Kit includes full installation instructions and a P100089 safety filter

fitting. For remote mounting, order a P105168 flange and a P105622 90° elbow.

The Informer™

Restriction Limit	Gauge Only	Kit (gauge & fitting)
20" H ₂ O/5 kPa	X002278	X002103
25" H ₂ O/6.2 kPa	X002277	X002102
30" H ₂ O/7.5 kPa	X002275	X002101

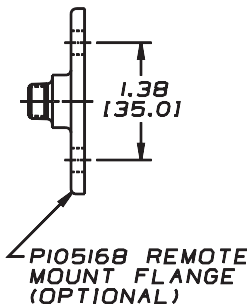
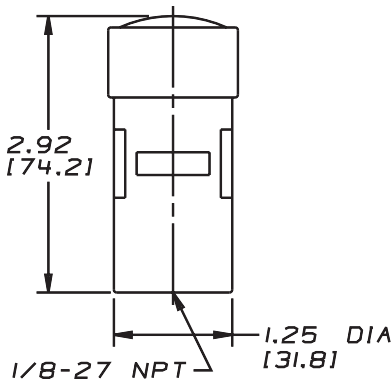

The Mini-Informer™ for Light & Medium Trucks



The Mini-Informer restriction gauge is designed to mount in the plastic air cleaners of passenger cars, light trucks, and sport utility vehicles. It's an accurate, durable, easy-to-read "go/no go" style indicator, smaller than the original Informer.

Through the clear window, a green flag shows when air filter restriction is below the service point. When the restriction reaches its limits, an orange flag imprinted with "change filter" pops up.

The Mini-Informer mounts in the air cleaner ducting in a rubber grommet.

The Mini-Informer™

Restriction Limit	Gauge & Grommet	Gauge Only
25" H ₂ O/6.2 kPa	X007276	X007335

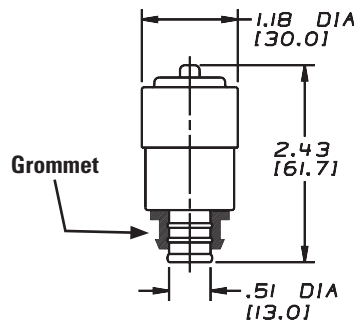

Restriction Tap Fittings

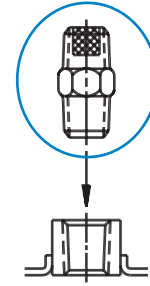

Part No. P100089

- Male threads both ends
- 1/8"-27 thread
- 0.44" (11mm) hex nut
- Internal sintered bronze safety filter

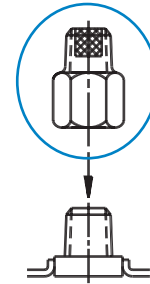

Part No. P122067

- Female threads on one end, male threads on opposite end
- 1/8"-27 thread
- Internal sintered bronze safety filter

Restriction Indicator Fitting

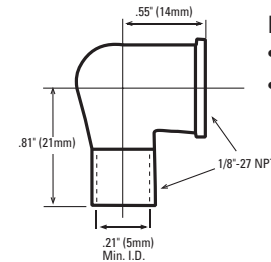

Part No. P105622

- 1/8"-27 threads
- 90° elbow with threaded end

Air Ram™ Inlet Hood

- Primarily over-highway trucks
- For engine airflow of 700 to 1000+ cfm
- Improves intake system airflow and fuel economy by reducing restriction, examples:
 - at 33 mph, 53 kmh = 3.5" H₂O restriction
 - at 45-52mph, 72-74 kmh = 4" H₂O restriction
 - at 60 mph, 97 kmh = 5" H₂O restriction
- Lightweight, non-corrosive, and durable – no service needed!
- Inlet screen prevents large debris from entering intake ducting
- Side louvers ensure continuous airflow to intake system
- Common inlet sizes fit most installations
- Eliminates water from air intake system
 - at 700 cfm airflow = 90%
 - at 800 cfm airflow = 93%
 - at 1000 cfm airflow = 93%*

* based on item H001660



H001654
High profile model mounts on inlet stack, above and behind cab.



H001200
Low profile model designed for air cleaners mounted on the side of the cab.

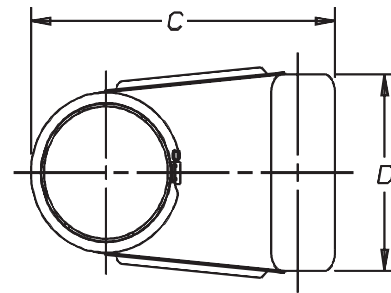
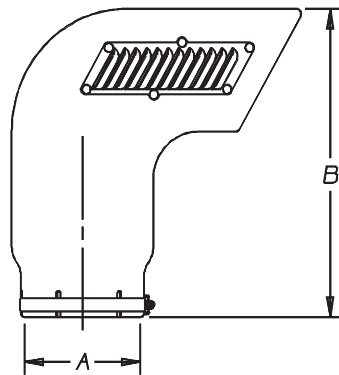

Air Ram Inlet Hood

Part Number	Inlet Diameter (A)		Height (B)		Depth (C)		Width (D)	
	in	mm	in	mm	in	mm	in	mm
MODELS WITH LOUVERS ON SIDE								
H001660	6.06	154	14.80	376	14.85	377	8.98	228
H001654	7.06	179	15.53	394	15.63	397	9.86	250
H001661	8.06	205	16.16	410	16.95	431	10.92	277
MODELS WITHOUT LOUVERS (LOW PROFILE)								
H001200	7.06	179	6.25	159	12.03	306	13.20	335

Note: One mounting band is included with each Air Ram

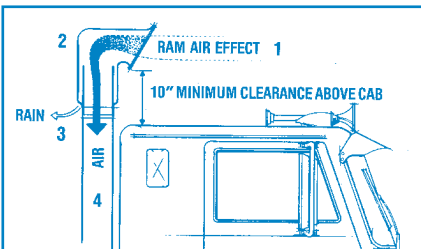

How Air Ram™ Works

- 1- Moisture-filled air enters Air Ram.
- 2- Air is naturally forced against rear wall. Moisture sticks to the wall, separating from the air.
- 3- Moisture collects on the Air Ram wall and drains down to and out of the drain hole.
- 4- Virtually moisture-free air passes into air cleaner.

Installation Note

All Air Ram inlet hoods **MUST** be installed with the screen facing forward to ensure best performance. Airflow restriction will not be reduced if the Air Ram faces sideways; but if it faces backwards, restriction does increase and adversely affects engine performance.

Inlet Hoods

- Protects engine air intake from rain, snow, birds, and other large contaminants
- Mounts on stack or directly to air cleaner for on-road and off-road equipment
- Four styles in a wide variety of sizes
- Installs easily with one clamp. Clamp included with hood on styles B, C and D

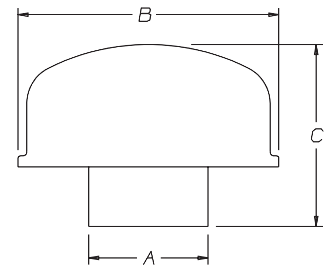

Inlet Hood - Style A¹

Fits O.D. (A)		Hood Dia. (B)		Height (C)		Add to Stack		Mat'l	Rain Shroud?	Weight		Part Number
inch	mm	inch	mm	inch	mm	inch	mm			lbs	kgs	
1.75	44	4.13	105	3.31	84	2.75	70	Metal	No	0.50	0.22	X002017
2.00	51	4.13	105	3.25	83	2.75	70	Metal	No	0.50	0.22	X002018
2.25	57	5.24	133	3.97	101	3.50	89	Metal	No	0.80	0.36	X002019
2.50	64	5.25	133	3.97	101	3.50	89	Metal	No	0.80	0.36	X001966
3.00	76	6.13	156	5.06	129	3.75	95	Metal	No	1.10	0.50	X002014
3.75	95	8.06	205	7.75	197	6.00	152	Metal	No	2.10	0.95	X001988
4.00	102	8.06	205	7.88	200	6.00	152	Metal	No	2.00	0.90	X002015

1 - Clamps must be ordered separately for this style

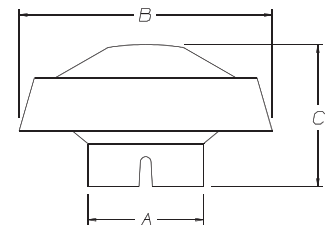

Inlet Hood - Style B

Fits O.D. (A)		Hood Dia. (B)		Height (C)		Add to Stack		Mat'l	Rain Shroud?	Weight		Part Number
inch	mm	inch	mm	inch	mm	inch	mm			lbs	kgs	
1.75	44	6.00	152	3.37	86	2.05	52	Plastic	No	0.20	0.09	H002068
2.00	51	6.00	152	3.31	84	2.50	64	Plastic	No	0.20	0.09	H001377
2.50	64	6.00	152	3.31	84	2.50	64	Plastic	No	0.20	0.09	H001378
3.00	76	6.00	152	3.31	84	2.50	64	Plastic	No	0.20	0.09	H001379

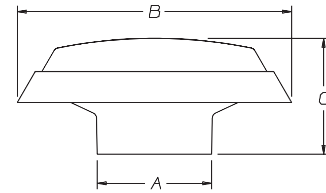

Inlet Hood - Style C

Fits O.D. (A)		Hood Dia. (B)		Height (C)		Add to Stack		Mat'l	Rain Shroud?	Weight		Part Number
inch	mm	inch	mm	inch	mm	inch	mm			lbs	kgs	
3.00	76	11.50	292	5.88	149	3.63	92	Plastic	No	1.10	0.50	H001063
3.75	95	11.50	292	5.13	130	3.63	92	Plastic	No	0.80	0.36	H000466
		11.50	292	5.13	130	3.63	92	Plastic	Yes	1.00	0.45	H000473
4.00	102	11.50	292	5.06	129	3.38	86	Plastic	No	0.90	0.40	H000467
		11.50	292	5.06	129	3.38	86	Plastic	Yes	1.00	0.45	H000472
4.50	114	11.50	292	4.88	124	3.38	86	Plastic	No	0.80	0.36	H000468
		11.50	292	4.88	124	3.38	86	Plastic	Yes	1.00	0.45	H000471
5.00	127	11.50	292	4.88	124	3.31	84	Plastic	No	0.80	0.36	H000469
		11.50	292	4.88	124	3.31	84	Plastic	Yes	1.00	0.45	H000470
		16.00	407	5.75	146	3.31	104	Plastic	Yes	1.80	0.80	H000605
5.50	140	16.00	407	5.75	146	4.94	125	Plastic	Yes	1.80	0.80	H000604
6.00	152	16.00	407	5.75	146	4.94	125	Plastic	Yes	1.80	0.80	H000606
		13.00	330	4.06	103	2.69	68	Bright	No	1.50	0.68	H001756
		16.00	406	5.69	145	4.25	108	Bright	Yes	1.50	0.68	H001948
7.00	178	12.81	325	4.81	122	3.44	87	Bright	No	1.50	0.68	H001773
		13.00	330	3.88	99	2.50	64	Bright	No	1.50	0.68	H001742
		16.00	406	5.75	146	4.09	104	Plastic	Yes	1.80	0.80	H000607
		16.00	406	5.69	145	4.25	108	Bright	Yes	1.50	0.68	H001947
		16.00	406	6.19	157	4.69	119	Plastic	Yes	1.80	0.80	H001053
8.00	203	16.00	406	6.19	157	4.60	117	Bright	Yes	1.50	0.68	H001946

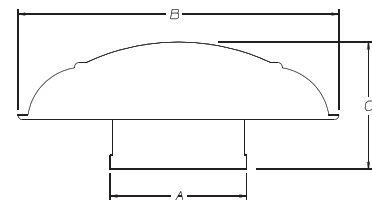

Inlet Hood - Style D

Fits O.D. (A)		Hood Dia. (B)		Height (C)		Add to Stack		Mat'l	Rain Shroud?	Weight		Part Number
inch	mm	inch	mm	inch	mm	inch	mm			lbs	kgs	
4.50	114	9.50	241	4.69	119	3.69	94	Metal	No	3.20	1.44	H000170
5.00	127	9.50	241	4.69	119	3.69	94	Metal	No	3.30	1.50	H000165
6.00	152	9.50	241	4.69	119	3.69	94	Metal	No	3.10	1.40	H000275
		9.50	241	4.69	119	3.69	94	Metal	Yes	3.20	1.44	H000276
7.03	179	17.00	432	6.75	171	5.75	146	Metal	No	4.60	2.08	H000339

ACCESSORIES

Stack-Top Moisture Eliminator

- For cabover trucks, on/off road, mounted on top of an intake stack
- Over 80% water removal efficiency
- Includes clamp for installation



Part No. X003691
 Airflow Range: 600-1200 cfm
 I.D. 7.00" / 178 mm

How It Works

- 1- Moisture-filled air enters the moisture eliminator cap.
- 2- Built-in, stationary vanes cause the air to spin.
- 3- Moisture is forced to the outside wall, where it separates from the air and collects.
- 4- Water drains out through the drain hole.
- 5- As a result, drier air (acceptable for maximum filter life and engine performance) passes to the air cleaner.

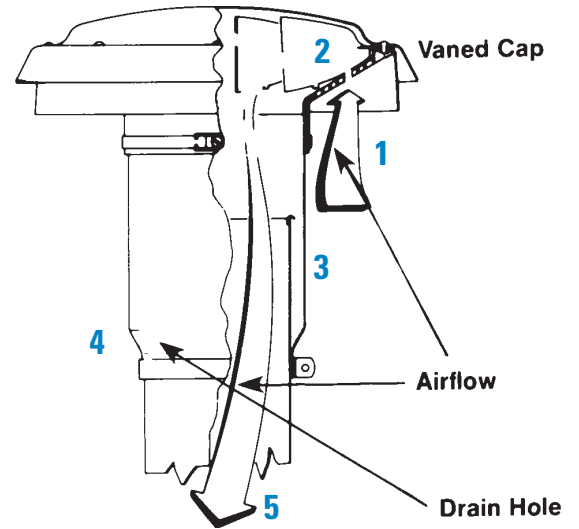

Air Stack Extensions

- For on-road and off-road trucks
- Helps extend filter life by elevating air inlet away from heavy dust concentrations and engine exhaust
- Installs easily and quickly with one clamp, which is included with unit
- Durable, corrosion-resistant steel construction

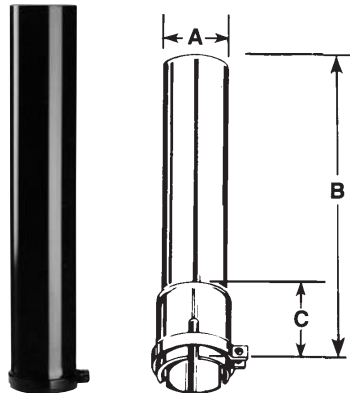

Air Stack Extensions

-(A - O.D.)-		-----(B)----		-----(C)----		Part Number
in	mm	in	mm	in	mm	
3.75	95	29.00	737	1.50	38	X001744
4.50	114	30.25	768	1.50	38	X001746
5.00	127	29.00	737	1.50	38	X001747
6.00	152	31.50	800	1.50	38	H000484
7.00	178	28.62	727	1.50	38	H000483

Air Cleaner Mounting Bands

ACCESSORIES



Most of our air cleaners with metal housings require two mounting bands.

- Durable, corrosion resistant, steel construction
- Fully engineered and tested to resist the adverse effects of vibration
- Mounting band feet are designed to ensure maximum torque pressure, continuously
- Gauge of steel increases as diameter of mounting band increases
- Bright stainless models available
- Bolt and nut included with mounting band

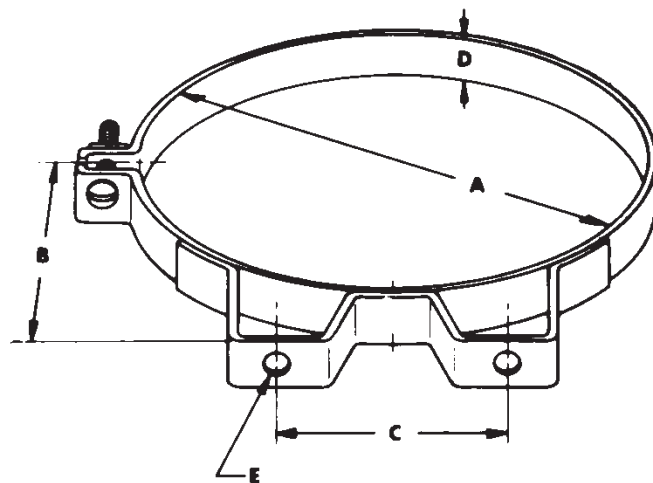

Air Cleaner Mounting Bands

A		B		C		D		E		Weight		Max. Bolt Torque		Part Number
inch	mm	inch	mm	inch	mm	inch	mm	inch	mm	lbs	kg	lbs-ft	N•m	
4.00	102	2.56	65	2.50	64	.75	19	.31	8	0.30	0.14	1.50	2.03	P007189
5.25	133	3.19	81	3.25	83	.88	22	.34	9	0.70	0.32	1.50	2.03	P002348
6.00	152	3.56	90	3.25	83	1.00	25	.34	9	0.80	0.36	1.50	2.03	P002351
6.50	165	3.88	99	3.75	95	.88	22	.41	10	0.70	0.32	2.00	2.71	P007191
7.00	178	4.13	105	4.50	114	.88	22	.30	8	0.80	0.36	3.00	4.07	P004906
7.75	197	4.44	113	4.25	108	1.00	25	.34	9	0.90	0.41	3.50	4.75	P003245
8.00	203	4.50	114	4.25	108	1.00	25	.34	9	1.10	0.50	4.00	5.42	P004307
9.00	229	5.13	130	4.5	114	1.25	32	.45	11	1.50	0.68	4.00	5.42	P004073
10.19	259	5.75	146	5.00	127	1.25	32	.45	11	1.50	0.68	4.00	5.42	P004076
11.00	279	6.13	156	5.00	127	1.25	32	.45	11	1.70	0.77	4.00	5.42	P004079
11.81	300	6.88	175	6.00	152	1.50	38	.41	10	2.50	1.13	4.00	5.42	H000349
13.00	330	7.25	184	6.00	152	1.50	38	.41	10	2.80	1.50	4.00	5.42	P013722
		7.25	184	6.00	152	1.50	38	.41	10	2.80	1.50	4.00	5.42	P522439*
14.00	356	8.13	207	8.00	203	1.50	38	.47	12	3.70	1.68	5.00	6.78	H000350
15.00	381	8.00	203	8.00	203	1.50	38	.47	12	4.10	1.86	6.00	8.14	P016845
		8.00	203	8.00	203	1.50	38	.47	12	4.10	1.86	6.00	8.14	P524552*
16.00	406	9.13	232	10.00	254	1.50	38	.47	12	4.75	2.16	5.00	6.78	H000351
18.00	457	9.2	234	15.75	400	1.96	50	.55	14	5.25	2.38	5.00	6.78	H770037
19.29	490	10.97	279	19.29	490	1.96	50	.55	14	6.39	2.9	5.00	6.78	H770068

* Bright Stainless Model

Mounting Bands Designed Exclusively for the FPG Series

Polymer Mounting Band

The one-piece, high tech polymer mounting band will securely hold the housing in position. The band has tabs on the inside circumference which fit exactly into notches on the FPG housing.

The band tightens around the air cleaner when the base of the band is bolted to a support, providing a fixed, stable mounting – even in high vibration applications.

Donaldson polymer bands are completely non-corrosive, lightweight, easy to install, and economical.

Application Note:

To accommodate even hard-to-fit applications, polymer bands allow the air cleaner housings to be rotated and positioned at various increments, depending upon the size:

Housing Diameter	Increment
4.80" (122mm)	11°
5.75" (146mm)	10°
6.74" (171mm)	7.5°
7.19" (183mm)	7°
8.35" (212mm)	5°

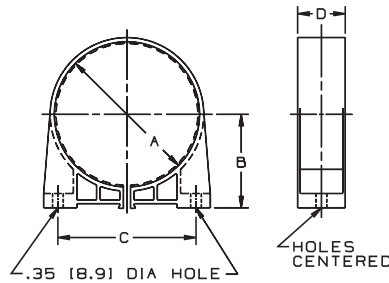

For G04 and G05 FPG Air Cleaners.

Bands for G06-G10 FPG Air Cleaners with springloaded screws

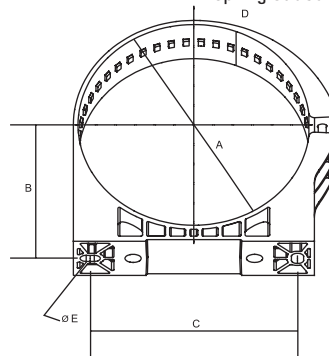

Metal Mounting Band

The metal mounting band has a spring-loaded bolt at the top to maintain a constant hold on the housing throughout high and low temperature extremes.

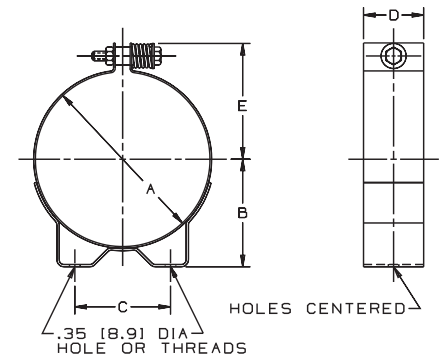

WARNING: Do not use any other mounting bands or straps with FPG air cleaners. Use of an unapproved mounting band voids warranty.

FPG Mounting Bands (Order one band per FPG air cleaner)

Part Number	A		B		C		D		E	Weight		Maximum Belt Torque		
	in	mm	in	mm	in	mm	in	mm		lbs	kgms	lbs.-ft.	N•m	
POLYMER BANDS														
P777151	4.80	122	3.09	79	4.56	116	1.57	40	n/a	0.26	118	11 lbs.-ft.	14.8 N•m	
P777730	5.75	146	3.52	90	5.35	136	1.99	51	n/a	0.37	167	11 lbs.-ft.	14.8 N•m	
P778810	6.79	173	3.94	100	6.00	154	1.99	51	n/a	0.40	182	11 lbs.-ft.	14.8 N•m	
P777731	7.17	182	4.11	105	6.50	165	1.99	51	n/a	0.45	206	11 lbs.-ft.	14.8 N•m	
P777732	8.35	212	4.70	120	7.48	190	1.99	51	n/a	0.56	253	11 lbs.-ft.	14.8 N•m	
P780532 ¹	9.48	241	5.47	136	5.63	143	1.99	51	n/a					
P780594 ¹	10.55	268	5.90	150	5.63	143	3.15	80	n/a					
METAL BANDS														
H008442	4.80	122	3.07	78	2.76	70	1.57	40	3.34	85	0.70	317	12 lbs.-ft.	16.2 N•m
H008443	5.75	146	3.54	90	3.15	80	1.99	51	3.83	97	1.30	590	12 lbs.-ft.	16.2 N•m
H008441 ²	6.79	173	3.94	100	3.54	90	1.99	51	4.35	111	1.40	635	12 lbs.-ft.	16.2 N•m
H008444	6.79	173	3.94	100	3.54	90	1.99	51	4.35	111	1.40	635	12 lbs.-ft.	16.2 N•m
H002070	7.19	183	4.09	104	3.74	95	1.99	51	4.55	116	1.50	680	12 lbs.-ft.	16.2 N•m
H002023	8.13	207	4.72	120	4.33	110	1.99	51	5.14	131	1.60	726	12 lbs.-ft.	16.2 N•m

1 - Mounting bands (with spring-loaded screws) for FPG09 and FPG10 models with twist-off cover
 2 - Model H008441 has 8mm threads

ACCESSORIES

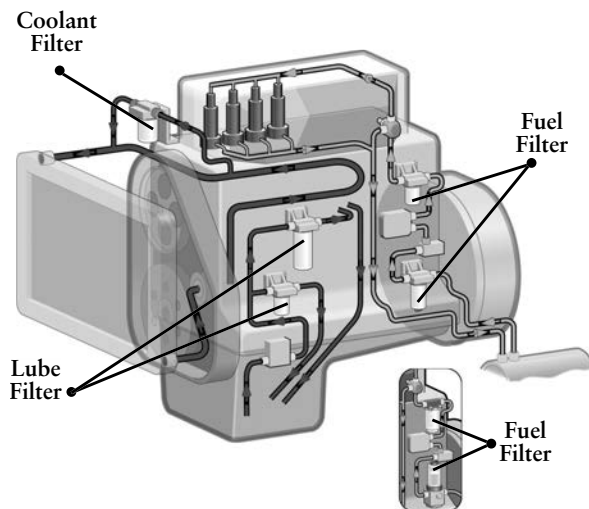
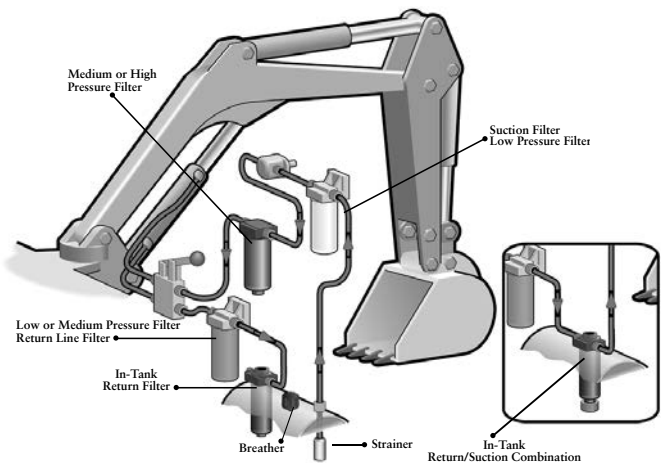
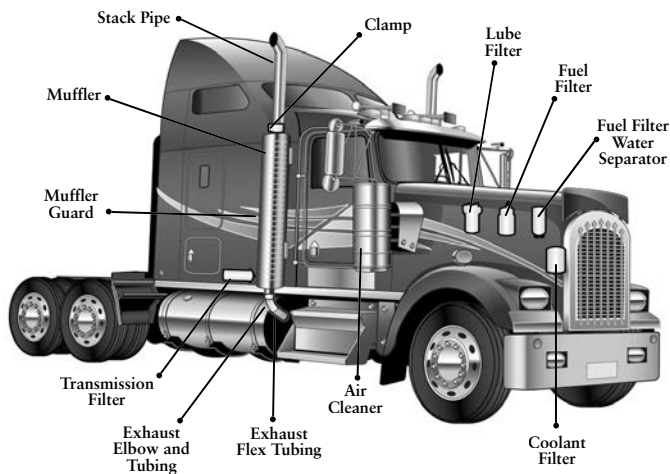
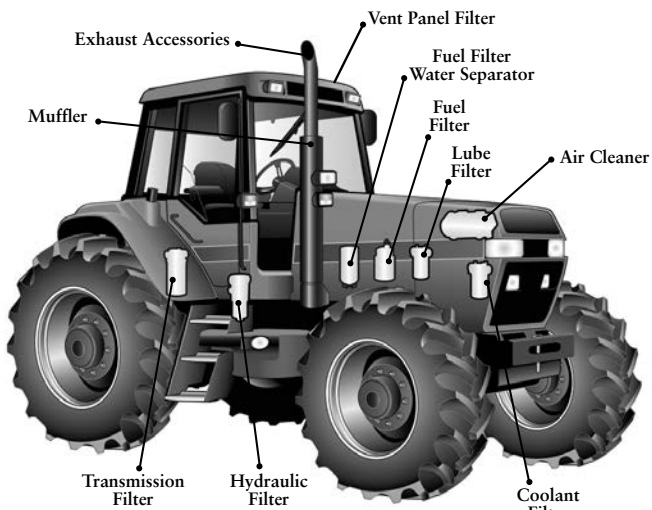
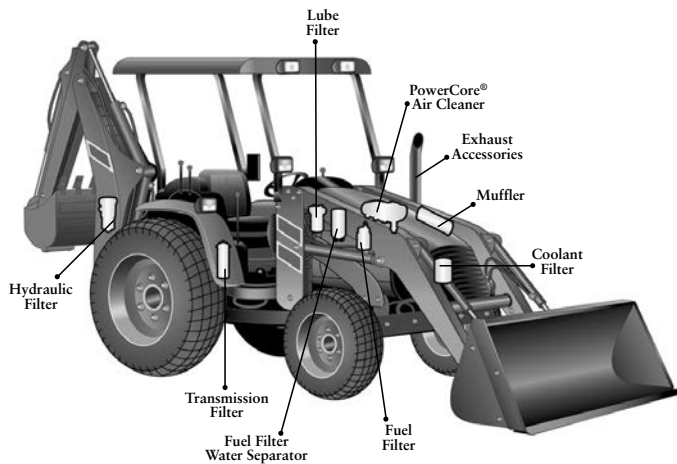
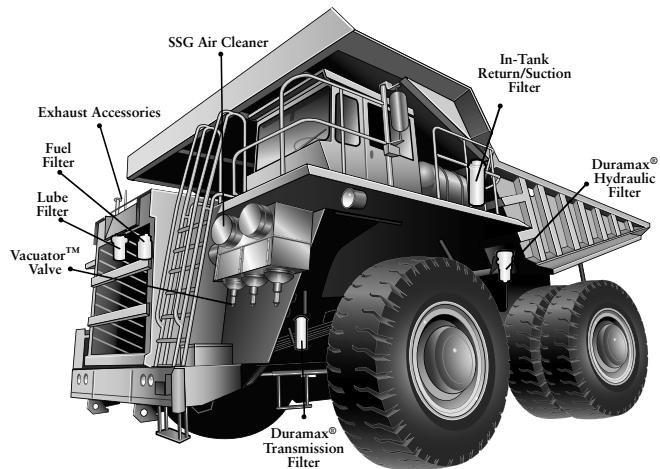



Section Index

Muffler Selection by Style with Attenuation Ranges & Exhaust Flow

Use this section to select a replacement muffler by style back pressure and attenuation range

If you're looking for a replacement for an off-road application, consider our off-road exhaust mufflers. These newer, painted, aluminized steel mufflers have some unique features as compared to our standard line. These mufflers are the ones shown in blue text.

Style 1	55
Style 2	56
Style 2A & 3	57
Style 4 & 5.....	58
Style 6	59

Muffler Dimensions by Part Number..... 60

Use this section to verify the dimensional characteristics of a Donaldson muffler.

Muffler Dimensions by Style

Use this section to verify the dimensional characteristics of a Donaldson muffler.

Style 1	68
Style 2	70
Style 3	69
Style 4	72
Style 5	73
Style 6	74

Muffler Selection by Style & Engine Exhaust Data

MUFFLER SPECS

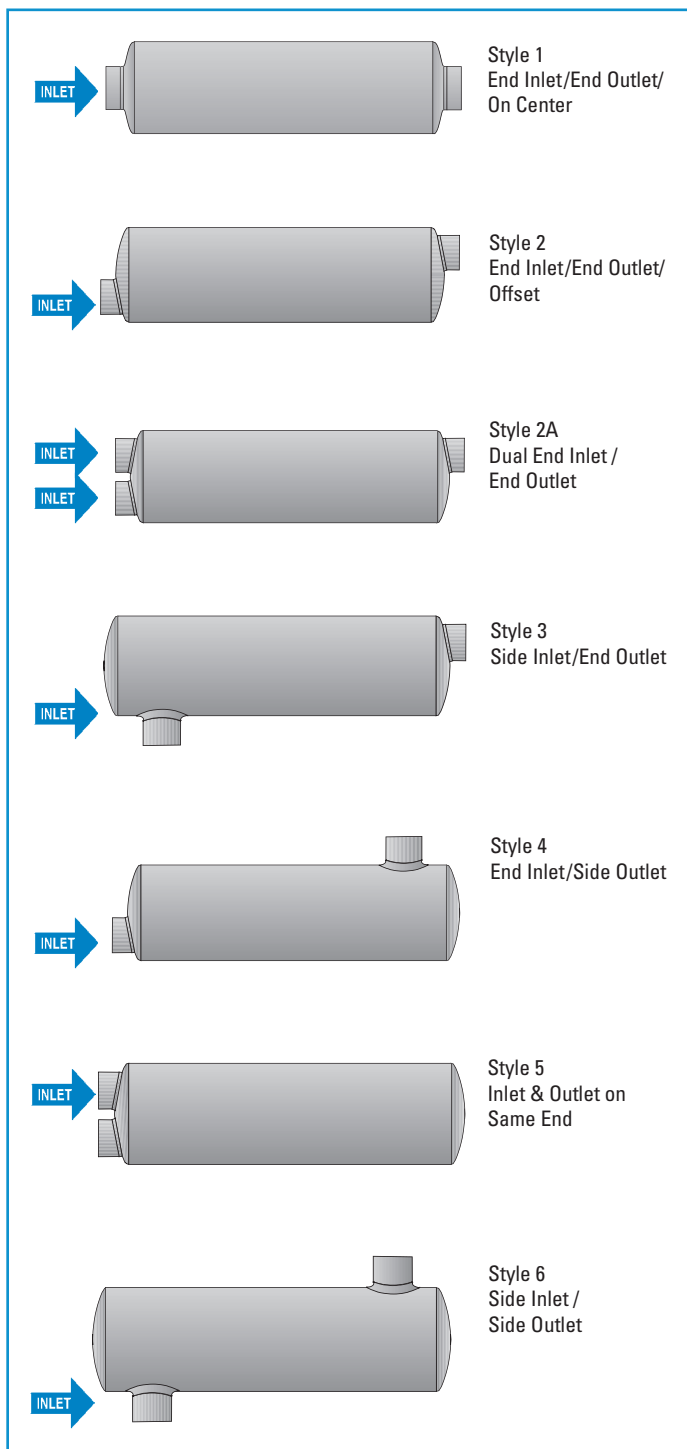

Selecting the Right Muffler for Your Engine

NOTE: Depending on your location, some diesel engines require the use of an emissions aftertreatment device to meet emissions regulations. In the United States, federal law prohibits the replacement of an emissions device (i.e., catalytic converter, combined catalytic converter/muffler, diesel particulate filter, etc.) with a non-emissions reducing (such as a straight pipe or conventional muffler) or un-approved emissions device. If operating the vehicle outside of the United States, make sure to check with and comply with any emission regulations for your locale.

Step 1

Determine the exhaust flow (CFM) and acceptable exhaust system backpressure of your engine, refer to your owners manual or contact your engine manufacturer for this information. To calculate exhaust flow, see our instructions on page 7.

Note: If you are spec'ing a dual muffler system divide engine's exhaust flow (CFM) by two.

Step 2

Find your muffler style (inlet/outlet positions and shape: round or oval) using the illustrations on the left. Proceed to the same style in page 53-57.

Step 3

Within the style, choose desired inlet diameter that is at or below your exhaust flow rate AND at or below the acceptable backpressure level.

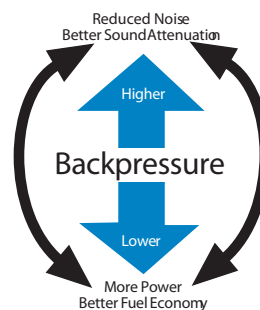

Muffler Size May Affect Backpressure:

Mufflers are key to vehicle and equipment performance because as the muffler decreases the sound, it may create more backpressure on exhaust flow. Typically, an increase in backpressure means decreased engine performance. A large muffler can be used to offset increased backpressure while maintaining overall acoustic performance.

Mufflers for Off-Road Use

Many of our mufflers are specifically designed for off-road equipment. These mufflers are shown in blue type on pages 53-59 and have the following features:

- High temperature black finish
- Mount or install in any position
- Aluminized steel construction
- All have round bodies with domed ends
- Slotted inlet/outlet connections



Choose the desired inlet diameter for the engine's air flow requirement that is at or below the acceptable backpressure level.

Style 1 - End Inlet/End Outlet/On Center

-- Inlet I.D. --		--- Outlet I.D. ---		Body Diameter		Body Length		Attenuation	Part Number	----- Exhaust Flow (cfm) @ -----		
inch	mm	inch	mm	inch	mm	inch	mm	Range dB(A)		3" Hg 40.8" H ₂ O	2" Hg 27.2" H ₂ O	1" Hg 13.6" H ₂ O
2.00	51	2.00	51	6.00	152	15.75	400	12-18	M060479	498	393	283
		2.10 OD	53 OD	4.38	111	12.50	318	8-12	M045237	531	433	306
2.50	64	2.50	64	6.62	168	17.75	451	12-18	M065138	780	613	441
		2.63 OD	67 OD	6.62	168	15.00	381	6-12	M065071	790	645	456
2.89	73	3.16 OD	80	8.50	216	31.75	806	15-20	M085293 ⁷	1091	891	630
3.00	76	3.00	76	8.50	216	19.75	502	12-18	M085407	1125	884	636
		3.13 OD	80 OD	8.00	203	12.18	309	10-15	M080018	835	682	482
		4.00	102	11.00	279	36.00	914	13-19	M111029	2193	1791	1266
3.50	89	3.50	89	7.00	178	14.00	356	10-15	M070028	1245	1017	719
		3.50	89	9.00	229	21.75	552	12-18	M091046	1525	1203	865
3.50	89	3.50	89	9.00	229	44.50	1130	18-25	M090146	1001	817	578
		4.00	102	8.50	216	34.37	873	12-18	M085421	2099	1714	1212
4.00	102	4.00	102	8.50	216	34.37	873	8-12	M085171	3119	2546	1800
		4.00	102	9.00	229	44.44	1129	13-18	M090544	2006	1638	1158
		4.00	102	9.00	229	20.00	508	10-15	M090594	1667	1361	962
		4.00	102	10.33	262	44.50	1130	25-35	M100464 ¹	1420	1159	820
		4.00	102	10.00	254	23.75	603	12-18	M101167	2000	1570	1130
		4.00	102	10.00	254	44.44	1129	12-18	M100466	1948	1590	1125
		4.00 OD	102 OD	9.00	229	29.31	744	10-15	M090095 ⁷	1628	1330	940
		5.00	127	9.00	229	44.44	1129	15-20	M090781	2639	2155	1524
		5.00	127	10.00	254	44.44	1129	19-25	M100695	1543	1260	891
		5.00	127	5.00	127	9.00	229	20.00	508	10-15	M090595	2478
5.00	127			9.00	229	44.44	1129	13-18	M090074	2887	2357	1667
5.00	127			9.00	229	44.44	1129	12-17	M090535	3260	3100	2340
5.00	127			10.00	254	44.44	1129	16-23	M100944	2950	2494	1765
5.00	127			10.00	254	44.44	1129	19-25	M100582	1600	1435	1015
5.00	127			10.00	254	44.44	1129	19-25	M101159 ⁴	1650	1465	1035
5.00	127			10.00	254	44.44	1129	19-25	M101182 ³	1650	1465	1035
5.00	127			10.00	254	44.44	1129	19-25	M100580	2530	2215	1565
5.00	127			10.00	254	44.44	1129	15-20	M100465	2790	2277	1610
5.00	127			10.00	254	44.44	1129	19-25	M101158 ⁴	2625	2305	1630
5.00	127			10.00	254	44.44	1129	19-25	M101181 ³	2625	2305	1630
5.00	127			10.00	254	44.44	1129	13-18	M100463	3260	3100	2340
5.00	127			10.00	254	44.44	1129	16-23	M101263	2530	2215	1565
5.00	127			10.00	254	59.95	1522	19-25	M100807	2610	2131	1507
5.00	127			11.00	279	50.50	1283	19-25	M110849	2950	2505	1775
5.00	127	11.84	301	25.75	654	12-18	M120747	3100	2450	1762		
2 NPT	2 NPT	6.00	152	14.50	368	8-12	M060247	776	633	448		
2.5 NPT	2.5NPT	6.00	152	15.00	381	8-12	M060005	773	631	446		
3 NPT	3 NPT	7.00	178	14.00	356	10-15	M070008	1293	1056	747		
3.5 NPT	3.5 NPT	7.00	178	18.38	467	10-15	M070050	1408	1149	813		
4 NPT	4 NPT	9.00	229	20.00	508	10-15	M090009	1767	1443	1020		

Mufflers in blue text have high temperature black finish and are designed for off-road applications.

1 - Wrapped muffler (reduces noise and surface temperature)
 3 - Silent Partner™ Exhaust & Engine Brake Silencer-Aluminized
 4 - Silent Partner™ Exhaust & Engine Brake Silencer-Stainless Steel
 7 - Face flange on inlet

Muffler Selection by Style, Attenuation & Exhaust Flow



Stated backpressure levels include muffler, average tubing lengths, and accessories.

Style 2 - End Inlet/End Outlet/Offset

MUFFLER SPECS

-- Inlet I.D. --		--- Outlet I.D. ---		Body Diameter		Body Length		Attenuation Range dB(A)	Part Number	----- Exhaust Flow (cfm) @ -----		
inch	mm	inch	mm	inch	mm	inch	mm			3" Hg 40.8" H ₂ O	2" Hg 27.2" H ₂ O	1" Hg 13.6" H ₂ O
2.00	51	2.00	51	6.00	152	15.75	400	12-18	M060480	498	393	283
		2.00	51	6.00	152	16.90	429	15-20	M060055	515	420	297
		2.00	51	6.00	152	24.00	610	15-20	M060232	515	420	297
2.50	64	2.50	64	6.62	168	17.75	451	12-18	M065139	780	613	441
		2.50	64	6.62	168	18.56	471	15-20	M065034	709	579	409
		2.50	64	6.62	168	27.75	705	16-22	M065065	709	579	409
3.00	76	3.00	76	8.3 x 11.5	211 x 292	26.00	660	19-25	M090170	828	676	478
		3.00	76	8.50	216	19.75	502	12-18	M085408	1125	884	636
		3.00	76	8.50	216	20.50	521	15-20	M085056	1094	894	632
		3.00	76	8.50	216	27.50	699	18-22	M085078	964	787	557
		3.00	76	8.50	216	27.75	705	18-22	M085080	964	787	557
		3.00	76	8.50	216	31.25	794	17-22	M085023	1094	894	632
		3.00	76	8.5 x 11.8	216 x 300	26.00	660	19-25	M090159 ¹	828	676	478
3.50	89	3.00	76	8.50	216	38.00	965	15-20	M085008	1124	918	649
		3.50	89	8.3 x 11.5	211 x 292	26.00	660	15-20	M090158	1325	1081	765
		3.50	89	9.00	229	21.75	552	12-18	M091047	1525	1203	865
		3.50	89	8.5 x 11.8	216 x 300	26.00	660	15-20	M090210 ¹	1325	1081	765
		4.00	102	8.2 x 11.5	208 x 292	26.00	660	13-18	M090520	1719	1403	992
		4.00	102	8.2 x 11.5	208 x 292	30.00	762	13-18	M090680	1719	1403	992
4.00	102	3.50	89	8.2 x 11.5	208 x 292	26.00	660	16-21	M090538	1340	1094	773
		4.00	102	10.00	254	23.75	603	12-18	M101168	2000	1570	1130
		4.00	102	8.2 x 11.5	208 x 292	26.00	660	12-18	M090280	1719	1403	992
		4.00	102	8.2 x 11.5	208 x 292	26.00	660	13-18	M090534	1776	1450	1025
		4.00	102	10.00	254	27.12	689	15-20	M100048	1702	1390	983
		4.00	102	10.00	254	35.38	899	15-20	M100043	1702	1390	983
		4.00	102	10 x 15	254 x 381	26.00	660	15-20	M120100	1997	1631	1153
		4.00	102	10.3 x 15.3	261 x 389	42.00	1067	22-28	M120197 ¹	1386	1131	800
		4.00	102	11.00	279	30.00	762	15-20	M110012	1730	1412	999
		4.00	102	11.00	279	36.00	914	19-25	M110189	1819	1485	1050
4 OD	102 OD	5.00	127	11.00	279	36.00	914	13-19	M111028	2393	1954	1382
5.00	127	5.00	127	10 x 15	254 x 381	26.00	660	15-20	M120225	2887	2357	1667
		5.00	127	10 x 15	254 x 381	26.00	660	15-20	M120108	2329	1902	1345
		5.00	127	10 x 15	254 x 381	36.00	914	15-20	M120365	2265	1849	1307
		5.00	127	10 x 15	254 x 381	44.00	1118	13-18	M120448	2222	1814	1283
		5.00	127	11.00	279	44.00	1118	13-18	M110077	2205	1800	1273
		5.00	127	11.84	301	25.75	654	12-18	M120748	3100	2450	1762
6.00	152	6.00	152	10 x 15	254 x 381	31.75	806	10-15	M122300	3740	3054	2159
		6.00	152	12 x 18	305 x 457	30.00	762	11-16	M140048	3765	3074	2174
		6.00	152	14 x 21	357 x 533	35.00	889	12-18	M170101	4113	3358	2375
8.00	203	8.00	203	16 x 24	406 x 607	45.00	1143	11-15	M190002	6352	5186	3667

Choose the desired inlet diameter for the engine's air flow requirement that is at or below the acceptable backpressure level.

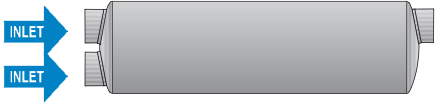

Choose the desired inlet diameter for the engine's air flow requirement that is at or below the acceptable backpressure level.

Style 2A - Dual End Inlet/End Outlet

-- Inlet I.D. --		--- Outlet I.D. ---		Body Diameter		Body Length		Attenuation Range dB(A)	Part Number	----- Exhaust Flow (cfm) @ -----		
inch	mm	inch	mm	inch	mm	inch	mm			3" Hg 40.8" H ₂ O	2" Hg 27.2" H ₂ O	1" Hg 13.6" H ₂ O
2.5 (2)	64 (2)	2.75	70	8.50	216	30.00	762	15-20	M085172	685	559	395
		3.00	76	8.50	216	31.25	794	15-20	M085189 ²	875	714	505
		3 OD	76 OD	8.75	222	30.12	765	19-25	M085267 ^{2,7}	1160	947	670
2.75 (2)	70 (2)	4.00	102	8.2 x 11.5	208 x 292	27.00	686	15-18	M090563	982	802	567

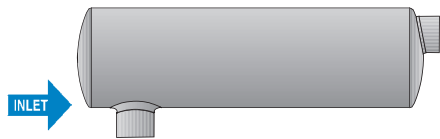

Mufflers in blue text have high temperature black finish and are designed for off-road applications.

Style 3 - Side Inlet/End Outlet

-- Inlet I.D. --		--- Outlet I.D. ---		Body Diameter		Body Length		Attenuation Range dB(A)	Part Number	----- Exhaust Flow (cfm) @ -----		
inch	mm	inch	mm	inch	mm	inch	mm			3" Hg 40.8" H ₂ O	2" Hg 27.2" H ₂ O	1" Hg 13.6" H ₂ O
1.68	43	1.64	42	4.38	111	13.78	350	12-18	M045193	220	180	127
2.00	51	2.00	51	6.00	152	15.75	400	12-18	M060481	498	393	283
		2.00	51	6.00	152	18.81	478	15-20	M060158	383	313	221
2.50	64	2.50	64	6.62	168	17.75	451	12-18	M065140	780	613	441
		2.50	64	6.62	168	20.89	531	15-20	M065044	564	461	326
3.00	76	3.00	76	8.50	216	19.75	502	12-18	M085409	1125	884	636
		3.00	76	8.80	224	27.12	689	15-20	M085226 ¹	808	659	466
3.02	77	3.00	76	8.50	216	26.25	667	15-20	M085090	808	659	466
3.50	89	3.00	76	8.50	216	27.00	686	12-18	M085084	801	654	462
		3.50	89	9.00	229	21.75	552	12-18	M091048	1525	1203	865
		3.50	89	8.3 x 11.5	211 x 292	26.13	664	15-20	M090301	1114	910	643
4.00	102	4.00	102	10.00	254	23.75	603	12-18	M101169	2000	1570	1130
		4.00	102	10.00	254	28.00	711	15-20	M100146	1341	1095	774
		4.00	102	11.00	279	33.00	838	15-20	M110674 ⁶	1677	1369	968
		4.00	102	11.00	279	36.00	914	19-25	M110479	1608	1313	928
		5.00	127	9.00	229	44.50	1130	15-20	M090823	2329	1902	1345
		5.00	127	11.84	301	32.13	816	12-18	M120598	2264	1848	1307
		5.00	127	10 x 15	254 x 381	21.00	533	12-17	M120566	2205	1800	1273
		3.85 OD	98 OD	10 x 15	254 x 381	15.00	381	12-18	M120382	2265	1849	1307
		Down Spout		11.00	279	36.00	914	13-19	M111024	1702	1390	983
		5.00	127	5.00	127	10.00	254	44.50	1130	13-18	M100213	2415
5.00	127			11.84	301	25.75	654	12-18	M120749	3100	2450	1762
5.00	127			10 x 15	254 x 381	35.87	911	15-20	M120235	2098	1713	1211

1 - Wrapped muffler (reduces noise and surface temperature)
 2 - Stainless Steel
 6 - Band clamp on inlet tube
 7 - Face flange on inlet

Muffler Selection by Style, Attenuation & Exhaust Flow



Stated backpressure levels include muffler, average tubing lengths, and accessories.

Style 4 - End Inlet/Side Outlet

MUFFLER SPECS

-- Inlet I.D. --		--- Outlet I.D. ---		Body Diameter		Body Length		Attenuation	Part	----- Exhaust Flow (cfm) @ -----		
inch	mm	inch	mm	inch	mm	inch	mm	Range	Number	3" Hg	2" Hg	1" Hg
								dB(A)		40.8" H ₂ O	27.2" H ₂ O	13.6" H ₂ O
2.00	51	2.00	51	6.00	152	15.75	400	12-18	M060481	498	393	283
2.50	64	2.50	64	6.62	168	17.75	451	12-18	M065140	780	613	441
3.00	76	3.00	76	8.50	216	19.75	502	12-18	M085409	1125	884	636
		3.00	76	8.50	216	26.25	667	15-20	M085206	715	583	413
3.50	89	3.50	89	9.00	229	21.75	552	12-18	M091048	1525	1203	865
		4.00	102	8.2 x 11.5	208 x 292	32.56	827	13-18	M090547	1500	1224	866
		4.00 OD	102 OD	8.2 x 11.5	208 x 292	32.56	827	13-18	M090548	1913	1562	1105
4.00	102	4.00	102	10.00	254	23.75	603	12-18	M101169	2000	1570	1130
		4.00	102	10.00	254	27.75	705	13-18	M100052	1679	1371	969
		4.00	102	11.00	279	36.00	914	15-21	M110112	1852	1512	1069
		4.00	102	11.00	279	36.00	914	15-21	M110148	1852	1512	1069
		4.00 OD	102 OD	11.00	279	36.00	914	15-21	M110311	1852	1512	1069
		4.00	102	10 x 15	254 x 381	30.38	772	15-20	M120367	1708	1394	986
		4.00	102	10 x 15	254 x 381	23.88	556	14-19	M120135	2100	1750	1260
		4.00 OD	102 OD	4.00 OD	102 OD	11.00	279	36.00	914	15-21	M111025	1976
5.00	127	5.00	127	11.00	279	46.00	1168	15-20	M110014	2462	2010	1421
		5.00	127	11.84	301	25.75	654	12-18	M120749	3100	2450	1762
		5.00	127	10 x 15	254 x 381	28.00	711	12-17	M120417	1895	1570	1130
		5.00	127	10 x 15	254 x 381	36.00	914	15-20	M120366	2400	1960	1386



Mufflers in blue text have high temperature black finish and are designed for off-road applications.

Style 5 - Inlet & Outlet on Same End

-- Inlet I.D. --		--- Outlet I.D. ---		Body Diameter		Body Length		Attenuation	Part	----- Exhaust Flow (cfm) @ -----		
inch	mm	inch	mm	inch	mm	inch	mm	Range	Number	3" Hg	2" Hg	1" Hg
								dB(A)		40.8" H ₂ O	27.2" H ₂ O	13.6" H ₂ O
2.00	51	2.00	51	6.00	152	15.75	400	12-18	M060482	498	393	283
		2.00	51	6.00	152	16.90	429	15-20	M060250	513	419	296
2.50	64	2.50	64	6.62	168	17.75	451	12-18	M065141	780	613	441
		2.50	64	6.62	168	20.00	508	15-20	M065073	718	586	414
3.00	76	3.00	76	8.50	216	22.00	559	15-20	M085207	1087	888	628
		3.00	76	8.50	216	19.75	502	12-18	M085410	1125	884	636
3.50	89	3.50	89	9.00	229	21.75	552	12-18	M091049	1525	1203	865
4.00	102	4.00	102	10.00	254	23.75	603	12-18	M101170	2000	1570	1130
		4.00	102	10.00	254	27.75	705	15-20	M100049	1450	1184	837
		4.00	102	10 x 15	254 x 381	26.00	660	18-20	M120154	1390	1135	803
		5.00	127	10 x 15	254 x 381	27.00	686	15-20	M120713	2069	1689	1159
5.00	127	5.00	127	10 x 15	254 x 381	26.25	667	15-20	M120176	2046	1670	1181
		5.00	127	10 x 15	254 x 381	26.00	660	8-12	M120131	2913	2378	1682
		5.00	127	10 x 15	254 x 381	33.38	848	19-25	M120189	2050	1674	1184
		5.00	127	10 x 15	254 x 381	44.00	1118	13-18	M120450	2679	2188	1547
		5.00	127	11.84	301	25.75	654	12-18	M120750	3100	2450	1762

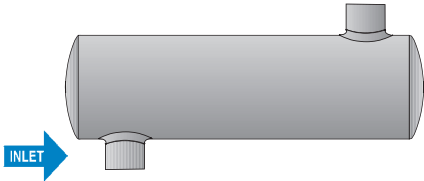

Stated backpressure levels include muffler, average tubing lengths, and accessories.

Style 6 - Side Inlet/Side Outlet

-- Inlet I.D. --		--- Outlet I.D. ---		Body Diameter		Body Length		Attenuation	Part Number	----- Exhaust Flow (cfm) @ -----		
inch	mm	inch	mm	inch	mm	inch	mm	Range dB(A)		3" Hg 40.8" H ₂ O	2" Hg 27.2" H ₂ O	1" Hg 13.6" H ₂ O
2.00	51	2.00	51	6.00	152	15.50	394	12-18	M060483	498	393	283
		2.00	51	6.00	152	18.81	478	12-18	M060251	487	398	281
2.50	64	2.50	64	6.62	168	17.50	444	12-18	M065142	780	613	441
		2.50	64	6.62	168	20.81	529	15-20	M065074	692	565	400
3.00	76	3.00	76	8.50	216	19.50	495	12-18	M085411	1125	884	636
		3.00	76	8.50	216	27.00	686	15-20	M085208	1043	651	602
3.50	89	3.50	89	8.3 x 11.5	211 x 292	26.00	660	15-20	M090598	1164	950	672
		3.50	89	9.00	229	21.50	546	12-18	M091050	1525	1203	865
4.00	102	4.00	102	10.00	254	23.50	597	12-18	M101171	2000	1570	1130
		4.00	102	10.12	257	28.00	711	15-20	M100572	1659	1355	958
		4 OD	102 OD	11.00	279	36.00	914	13-19	M111026	1887	1541	1090
5.00	127	5.00	127	11.84	301	25.50	648	12-18	M120751	3100	2450	1762
		5.00	127	10 x 15	254 x 381	28.00	711	15-20	M120418	2350	1919	1357

Mufflers in blue text have high temperature black finish and are designed for off-road applications.

Choose the desired inlet diameter for the engine's air flow requirement that is at or below the acceptable backpressure level.

Style 1 - End Inlet /End Outlet /On Center

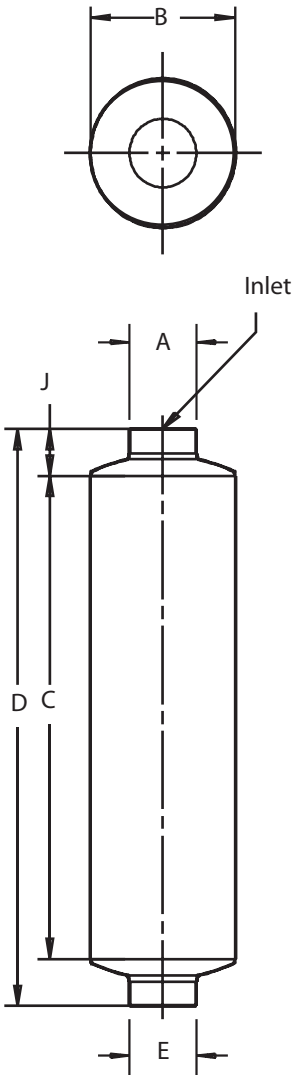

Style 2 - End Inlet /End Outlet /Offset

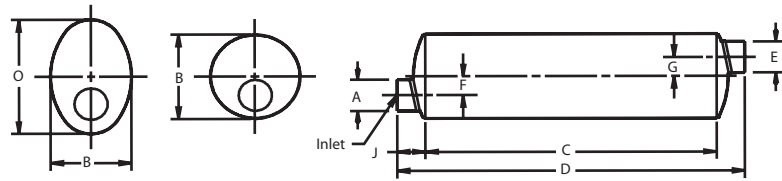

Style 2A - Dual End Inlet /End Outlet

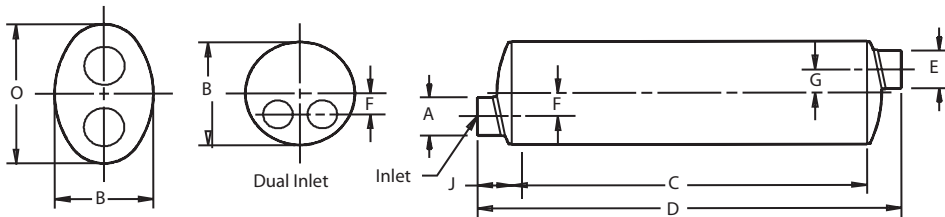

Style 3 - Side Inlet /End Outlet

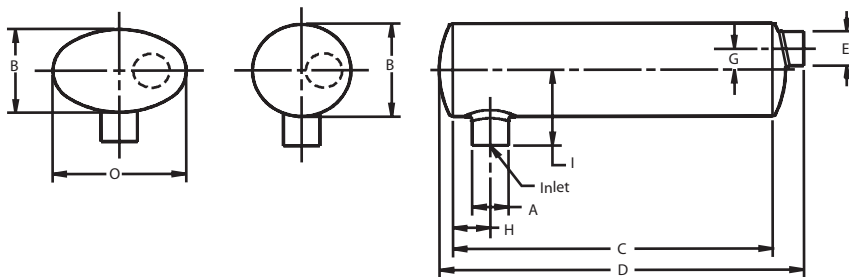

Style 4 - End Inlet /Side Outlet

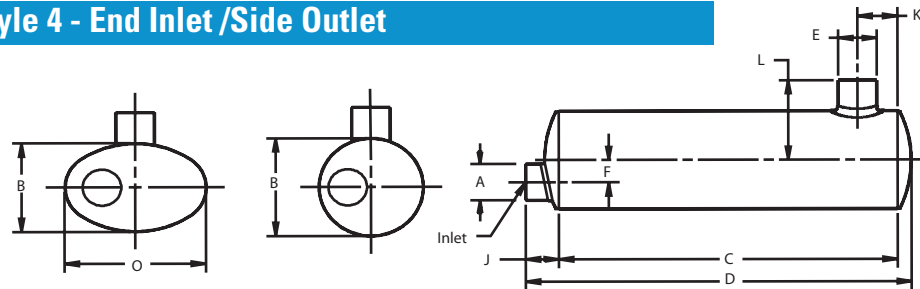

Style 5 - Inlet & Outlet on Same End

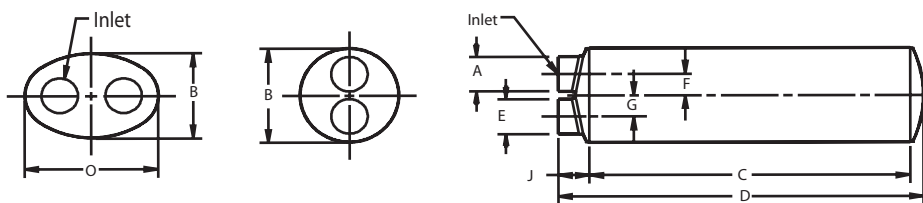

Style 6 - Side Inlet /Side Outlet

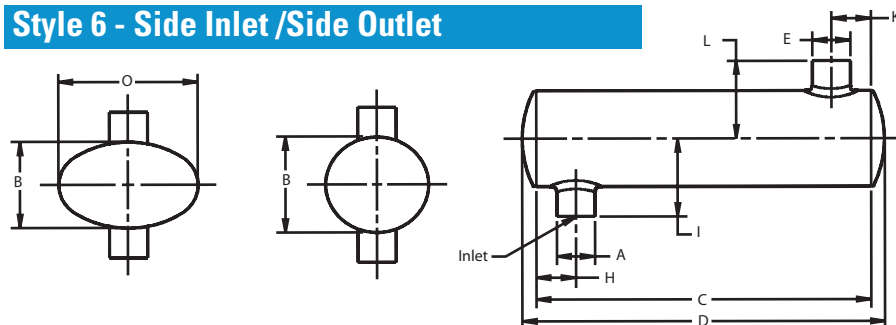

Part Number	Muffler Style	Body				Outlet I.D. (E)	Offset		Inlet Tube			Outlet Tube from End Center		Clock Position		Wgt lbs. kg
		Inlet I.D. (A)	Dia. (B) or (BxO)	Length (C)	Overall Length (D)		Inlet (F)	Outlet (G)	Loc. (H)	Length (I)	Length (J)	End Center (K)	Center (L)	Inlet	Outlet	
M045193	3	1.68 43	4.38 111	13.78 350	15.78 401	1.64 42			2.75 70	4.00 102				12:00		4 2
M045237	1	2.00 51	4.38 111	12.50 318	17.00 432	2.10 OD 53 OD					2.50 64					4 2
M060005	1	2.5 NPT	6.00 152	15.00 381	18.12 460	2.5NPT					1.56 40					9 4
M060055	2	2.00 51	6.00 152	16.90 429	21.90 556	2.00 51	1.50 38	1.50 38			2.50 64			6:00 12:00		7 3
M060158	3	2.00 51	6.00 152	18.81 478	21.50 546	2.00 51		1.50 38	3.50 89	5.00 127				3:00 6:00		9 4
M060232	2	2.00 51	6.00 152	24.00 610	29.00 737	2.00 51	1.50 38	1.50 38			2.50 64			6:00 12:00		9 4
M060247	1	2 NPT	6.00 152	14.50 368	20.00 508	2 NPT					2.75 70					7 3
M060250	5	2.00 51	6.00 152	16.90 429	19.40 493	2.00 51	1.50 38	1.50 38			2.50 64			6:00 12:00		8 4
M060251	6	2.00 51	6.00 152	18.81 478	18.81 478	2.00 51			3.50 89	5.00 127		3.50 89	5.00 127	6:00 12:00		8 4
M060479 ⁸	1	2.00 51	6.00 152	15.75 400	21.00 533	2.00 51					2.62 67					7.6 3.4
M060480 ⁸	2	2.00 51	6.00 152	15.75 400	21.00 533	2.00 51	1.50 38	1.50 38			2.62 67			6:00 12:00		7.6 3.4
M060481 ⁹	3/4	2.00 51	6.00 152	15.75 400	19.25 489	2.00 51			1.88 48	5.00 127				6:00		7.6 3.4
M060482 ⁸	5	2.00 51	6.00 152	15.75 400	19.25 489	2.00 51	1.50 38	1.50 38			2.62 67					8.4 3.8
M060483 ⁸	6	2.00 51	6.00 152	15.50 394	17.24 438	2.00 51			1.75 44	5.00 127		1.75 44	5.00 127	6:00 12:00		7.4 3.4
M065034	2	2.50 64	6.62 168	18.56 471	23.00 584	2.50 64	1.62 41	1.62 41			1.50 38			6:00 12:00		9 4
M065044	3	2.50 64	6.62 168	20.89 531	23.50 597	2.50 64		1.62 41	3.50 89	6.00 152				6:00 9:00		12 5
M065065	2	2.50 64	6.62 168	27.75 705	35.00 889	2.50 64	1.62 41	1.62 41			3.50 89			6:00 12:00		13 6
M065071	1	2.50 64	6.62 168	15.00 381	22.00 559	2.60 OD 66 OD					3.50 89					7 3
M065073	5	2.50 64	6.62 168	20.00 508	21.50 546	2.50 64	1.62 41	1.62 41			1.50 38			6:00 12:00		10 5
M065074	6	2.50 64	6.62 168	20.81 529	20.81 529	2.50 64			3.50 89	6.00 152		3.50 89	6.00 152	6:00 12:00		10 5
M065138 ⁸	1	2.50 64	6.62 168	17.75 451	24.00 610	2.50 64					3.12 79					9.8 4.5
M065139 ⁸	2	2.50 64	6.62 168	17.75 451	24.00 610	2.50 64	1.62 41	1.62 41			3.12 79			6:00 12:00		9.8 4.5
M065140 ⁹	3/4	2.50 64	6.62 168	17.75 451	22.04 560	2.50 64			2.38 60	5.75 146				6:00		10 4.5
M065141 ⁸	5	2.50 64	6.62 168	17.75 451	22.04 560	2.50 64	1.63 41	1.63 41			3.12 79			6:00 12:00		10.6 4.8
M065142 ⁸	6	2.50 64	6.62 168	17.50 444	19.84 504	2.50 64			2.50 64	5.75 146		2.25 57	5.75 146	6:00 12:00		9.4 4.2

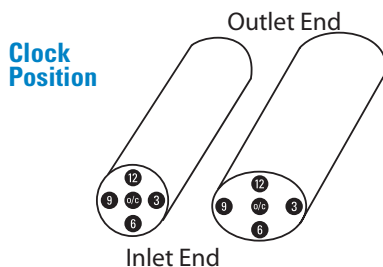
Footnotes

- | | |
|---|--|
| 1 Wrapped muffler (reduces noise and surface temperature) | 6 Band clamp on inlet tube |
| 2 Stainless Steel | 7 Face flange on inlet |
| 3 Silent Partner™ Muffler -Aluminized | 8 Made for off-road use |
| 4 Silent Partner™ Muffler -Stainless Steel | 9 Made for off-road use, flows in either direction |
| 5 Resonator | |

Muffler Specifications by Part Number



MUFFLER SPECS

Part Number	Muffler Style	Body				Outlet I.D. (E)	Offset		Inlet Tube			Outlet Tube from End Center		Clock Position		Wgt lbs. kg
		Inlet I.D. (A)	Dia. (B) or (BxO)	Length (C)	Overall Length (D)		Inlet (F)	Outlet (G)	Loc. (H)	Length (I)	Length (J)	End Center (K)	Center (L)	Inlet	Outlet	
M070008	1	3 NPT	7.00 178	14.00 356	19.75 502	3 NPT					2.38 60					13 6
M070028	1	3.50 89	7.00 178	14.00 356	19.75 502	3.50 89					2.38 60					10 5
M070050	1	3.5 NPT	7.00 178	18.38 467	25.62 651	3.5 NPT					3.00 76					18 8
M080018	1	3.00 76	8.00 203	12.18 309	17.00 432	3.13 OD 80 OD					1.38 35					10 5
M085008	2	3.50 89	8.50 216	38.00 965	43.00 1092	3.00 76	1.75 44	2.00 51			2.50 64			6:00 12:00		23 10
M085023	2	3.00 76	8.50 216	31.25 794	36.25 921	3.00 76	2.00 51	2.00 51			2.50 64			6:00 12:00		19 9
M085056	2	3.00 76	8.50 216	20.50 521	25.00 635	3.00 76	2.00 51	2.00 51			1.50 38			6:00 12:00		14 6
M085078	2	3.00 76	8.50 216	27.50 699	32.00 813	3.00 76	2.00 51	2.00 51			1.50 38			6:00 12:00		20 9
M085080	2	3.00 76	8.50 216	27.75 705	33.75 857	3.00 76	2.00 51	2.00 51			3.50 89			6:00 6:00		20 9
M085084	3	3.50 89	8.50 216	27.00 686	29.50 749	3.00 76		2.00 51	4.50 114	7.25 184				3:00 6:00		20 9
M085090	3	3.02 77	8.50 216	26.25 667	29.50 749	3.00 76		2.00 51	3.50 89	6.75 171				3:00 6:00		20 9
M085171	1	4.00 102	8.50 216	34.37 873	40.00 1016	4.00 102					2.50 64					21 10
M085172	2A	2.50 (2) 64 (2)	8.50 216	30.00 762	39.00 991	2.75 70	1.62 (2) 41 (2)	2.00 51			2.50 (2) 64 (2)			6:00(2) 6:00		24 11
M085189 ²	2A	2.50 (2) 64 (2)	8.50 216	31.25 794	36.25 921	3.00 76	1.62 (2) 41 (2)	2.00 51			2.50 (2) 64 (2)			6:00 (2) 12:00		23 10
M085206	4	3.00 76	8.50 216	26.25 667	29.50 749	3.00 76	2.00 51				3.25 83	3.50 89	6.75 171	6:00 9:00		20 9
M085207	5	3.00 76	8.50 216	22.00 559	23.50 597	3.00 76	2.00 51	2.00 51			1.50 38			6:00 12:00		16 7
M085208	6	3.00 76	8.50 216	27.00 686	27.00 686	3.00 76			3.50 89	6.75 171		3.50 89	6.75 171	6:00 12:00		17 8
M085226 ¹	3	3.00 76	8.80 224	27.12 689	29.56 751	3.00 76		2.00 51	4.56 116	6.75 171				3:00 6:00		28 13
M085267 ^{1,2}	2A	2.50 (2) ⁷ 64 (2) ⁷	8.75 222	30.12 765	38.97 990	3 OD 76 OD	1.62 (2) 41 (2)	2.00 51			5.72/3.22 146/82			6:00 (2) 12:00		32 15
M085293	1	2.89 ⁷ 73 ⁷	8.50 216	31.75 806	46.25 1175	3.16 OD 80 OD										28 12
M085407 ⁸	1	3.00 76	8.50 216	19.75 502	26.50 673	3.00 76					3.38 86					15.2 7
M085408 ⁸	2	3.00 76	8.50 216	19.75 502	26.50 673	3.00 76	2.00 51	2.00 51			3.38 86			6:00 12:00		15.2 7
M085409 ⁹	3/4	3.00 76	8.50 216	19.75 502	24.27 616	3.00 76			2.88 73	6.50 165				6:00		15.4 7
M085410 ⁸	5	3.00 76	8.50 216	19.75 502	24.27 616	3.00 76	2.00 51	2.00 51			3.38 86			6:00 12:00		17 7.7
M085411 ⁸	6	3.00 76	8.50 216	19.50 495	21.78 553	3.00 76			3.00 76	6.50 165		3.00 76	6.50 165	6:00 12:00		14.2 6.4
M085421	1	4.00 102	8.50 216	34.37 873	40.00 1016	4.00 102					2.50 64					21 10
M090009	1	4 NPT	9.00 229	20.00 508	26.00 660	4 NPT					3.00 76					23 10
M090072 ⁵	1	5.00 127	9.00 229	10.00 254	16.50 419	5.00 127					3.00 76					9 4

Part Number	Muffler Style	Body				Outlet I.D. (E)	Offset		Inlet Tube			Outlet Tube from End Center (L)		Clock Position		Wgt lbs. kg
		Inlet I.D. (A)	Dia. (B) or (BxO)	Length (C)	Overall Length (D)		Inlet (F)	Outlet (G)	Loc. (H)	Length (I)	Length (J)	Inlet	Outlet	Inlet	Outlet	
M090074	1	5.00 127	9.00 229	44.44 1129	51.00 1295	5.00 127					3.00 76					29 13
M090095	1	4.00 ⁷ 102 ⁷	9.00 229	29.31 744	73.00 1854	4 OD 102 OD										33 15
M090146	1	3.50 89	9.00 229	44.50 1130	51.00 1295	3.50 89					3.00 76					32 15
M090158	2	3.50 89	8.3 x11.5 211 x 292	26.00 660	32.25 819	3.50 89	2.50 64	2.50 64			3.12 79			3:00 9:00		24 11
M090159 ¹	2	3.00 76	8.5 x11.8 216 x 300	26.00 660	33.75 857	3.00 76	2.50 64	2.50 64			3.88 99			3:00 3:00		29 13
M090170	2	3.00 76	8.3 x11.5 211 x 292	26.00 660	33.75 857	3.00 76	2.50 64	2.50 64			3.88 99			3:00 3:00		20 9
M090210 ¹	2	3.50 89	8.5 x11.8 216 x 300	26.00 660	32.25 819	3.50 89	2.50 64	2.50 64			3.12 79			3:00 9:00		34 15
M090280	2	4.00 102	8.2 x11.5 208 x 292	26.00 660	32.25 819	4.00 102	2.50 64	2.50 64			3.12 79			3:00 9:00		22 10
M090301	3	3.50 89	8.3 x11.5 211 x 292	26.13 664	29.25 743	3.50 89		2.50 64	3.25 83	7.00 178				6:00 9:00		23 10
M090362 ⁵	1	4.00 102	9.00 229	10.00 254	16.50 419	4.00 102					3.00 76					9 4
M090520	2	3.50 89	8.2 x11.5 208 x 292	26.00 660	32.25 819	4.00 102	2.50 64	2.50 64			3.12 79			3:00 9:00		21 10
M090534	2	4.00 102	8.2 x11.5 208 x 292	26.00 660	33.75 857	4.00 102	2.50 64	2.50 64			3.88 99			3:00 9:00		26 12
M090535	1	5.00 127	9.00 229	44.44 1129	51.00 1295	5.00 127					3.00 76					30 14
M090538	2	4.00 102	8.2 x11.5 208 x 292	26.00 660	32.25 819	3.50 89	2.50 64	2.50 64			3.12 79			3:00 12:00		26 12
M090544	1	4.00 102	9.00 229	44.44 1129	51.00 1295	4.00 102					3.00 76					27 12
M090547	4	3.50 89	8.2 x11.5 208 x 292	32.56 827	35.16 893	4.00 102	2.50 64				2.60 66	20.48 520	6.00 152	9:00 7:00		22 10
M090548	4	3.50 89	8.2 x11.5 208 x 292	32.56 827	35.16 893	4 OD 102 OD	2.50 64				2.60 66	20.48 520	8.70 221	3:00 7:30		21 10
M090563	2A	2.75 (2) 70 (2)	8.2 x11.5 208 x 292	27.00 686	32.75 832	4.00 102	0.15/4.00 9/102	2.50 64			2.63 (2) 67 (2)			9:00-3:00 3:00		22 10
M090594	1	4.00 102	9.00 229	20.00 508	26.50 673	4.00 102					3.00 76					14 6
M090595	1	5.00 127	9.00 229	20.00 508	26.50 673	5.00 127					3.00 76					15 7
M090598	6	3.50 89	8.3 x11.5 211 x 292	26.00 660	26.00 660	3.50 89			3.38 86	7.00 178		3.38 86	7.00 178	6:00 12:00		20 9
M090680	2	3.50 89	8.2 x11.5 208 x 292	30.00 762	36.25 921	4.00 102	2.50 64	2.50 64			3.12 79			3:00 9:00		25 11
M090781	1	4.00 102	9.00 229	44.44 1129	51.00 1295	5.00 127					3.00 76					30 14
M090823	3	4.00 102	9.00 229	44.50 1130	48.00 1219	5.00 127			3.81 97	6.69 170				6:00		30 13
M091046 ⁸	1	3.50 89	9.00 229	21.75 552	29.00 737	3.50 89					3.62 89					15.8 7.2

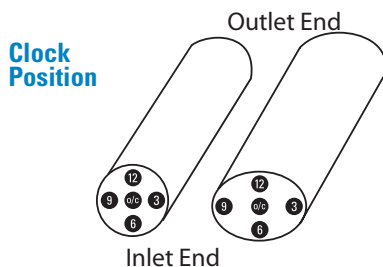

Footnotes

- 1 Wrapped muffler (reduces noise and surface temperature)
- 2 Stainless Steel
- 3 Silent Partner™ Muffler -Aluminized
- 4 Silent Partner™ Muffler -Stainless Steel
- 5 Resonator
- 6 Band clamp on inlet tube
- 7 Face flange on inlet
- 8 Made for off-road use
- 9 Made for off-road use, flows in either direction

Muffler Specifications by Part Number



MUFFLER SPECS

Part Number	Muffler Style	Body				Offset			Inlet Tube			Outlet Tube from End Center		Clock Position		Wgt lbs. kg
		Inlet I.D. (A)	Dia. (B) or (BxO)	Length (C)	Overall Length (D)	Inlet I.D. (E)	Inlet (F)	Outlet (G)	Loc. (H)	Length (I)	Length (J)	End Center (K)	(L)	Inlet	Outlet	
M091047 ⁸	2	3.50 89	9.00 229	21.75 552	29.00 737	3.50 89	2.10 53	2.10 53			3.62 89			6:00	12:00	15.8 7.2
M091048 ⁹	3/4	3.50 89	9.00 229	21.75 552	26.38 670	3.50 89			3.38 86	7.25 184				6:00		15.9 7.2
M091049 ⁸	5	3.50 89	9.00 229	21.75 552	26.44 672	3.50 89	2.10 53	2.10 53			3.62 89			6:00	12:00	17.3 7.9
M091050 ⁸	6	3.50 89	9.00 229	21.50 546	23.64 600	3.50 89			3.25 83	7.25 184		3.25 83	7.25 184	6:00	12:00	15.1 6.9
M100043	2	4.00 102	10.00 254	35.38 899	41.75 1060	4.00 102	2.44 62	2.44 62			2.88 73			6:00	12:00	32 15
M100048	2	4.00 102	10.00 254	27.12 689	33.50 851	4.00 102	2.44 62	2.44 62			2.88 73			6:00	12:00	27 12
M100049	5	4.00 102	10.00 254	27.75 705	30.62 778	4.00 102	2.44 62	2.44 62			2.88 73			12:00	6:00	23 10
M100052	4	4.00 102	10.00 254	27.75 705	30.75 781	4.00 102	2.44 62				3.00 76	24.25 616	8.75 222	6:00	2:00	25 11
M100146	3	4.00 102	10.00 254	28.00 711	32.00 813	4.00 102		2.44 62	4.50 114	8.00 203				6:00	9:00	27 12
M100213	3	5.00 127	10.00 254	44.50 1130	48.00 1219	5.00 127			5.50 140	7.50 191				6:00		33 15
M100463	1	5.00 127	10.00 254	44.44 1129	51.00 1295	5.00 127					3.00 76					31 14
M100464 ¹	1	4.00 102	10.33 262	44.50 1130	51.00 1295	4.00 102					3.00 76					52 24
M100465	1	5.00 127	10.00 254	44.44 1129	51.00 1295	5.00 127					3.00 76					28 13
M100466	1	4.00 102	10.00 254	44.44 1129	51.00 1295	4.00 102					3.00 76					27 12
M100572	6	4.00 102	10.12 257	28.00 711	30.62 778	4.00 102			4.50 114	8.00 203		4.50 114	8.00 203	6:00	12:00	22 10
M100580	1	5.00 127	10.00 254	44.44 1129	51.00 1295	5.00 127					3.00 76					29 13
M100582	1	5.00 127	10.00 254	44.44 1129	51.00 1295	5.00 127					3.00 76					31 14
M100695	1	4.00 102	10.00 254	44.44 1129	51.00 1295	5.00 127					3.00 76					30 14
M100807	1	5.00 127	10.00 254	59.94 1522	66.50 1689	5.00 127					3.00 76					48 22
M100944	1	5.00 127	10.00 254	44.44 1129	51.00 1295	5.00 127					3.00 76					32 15
M101158 ⁴	1	5.00 127	10.00 254	44.44 1129	51.00 1295	5.00 127					3.00 76					43 20
M101159 ⁴	1	5.00 127	10.00 254	44.44 1129	51.00 1295	5.00 127					3.00 76					43 20
M101167 ⁸	1	4.00 102	10.00 254	23.75 603	32.00 813	4.00 102					4.12 105					19.3 8.8
M101168 ⁸	2	4.00 102	10.00 254	23.75 603	32.00 813	4.00 102	2.44 62	2.44 62			4.12 105			6:00	12:00	19.3 8.8
M101169 ⁹	3/4	4.00 102	10.00 254	23.75 603	29.24 743	4.00 102			3.88 99	8.00 203				6:00		19.8 9
M101170 ⁸	5	4.00 102	10.00 254	23.75 603	29.24 743	4.00 102	2.44 62	2.44 62			4.12 105			6:00	12:00	22 10
M101171 ⁸	6	4.00 102	10.00 254	23.50 597	26.24 666	4.00 102			3.75 95	8.00 203		3.75 95	8.00 203	6:00	12:00	19.1 8.7
M101181 ³	1	5.00 127	10.00 254	44.44 1129	51.00 1295	5.00 127					3.00 76					43 20
M101182 ³	1	5.00 127	10.00 254	44.44 1129	51.00 1295	5.00 127					3.00 76					43 20

Part Number	Muffler Style	Body				Outlet I.D. (E)	Offset		Inlet Tube			Outlet Tube from End Center (L)		Clock Position		Wgt lbs. kg
		Inlet I.D. (A)	Dia. (B) or (BxO)	Length (C)	Overall Length (D)		Inlet (F)	Outlet (G)	Loc. (H)	Length (I)	Length (J)	Inlet (K)	Outlet (L)	Inlet	Outlet	
M101263	1	5.00 127	10.00 254	44.44 1129	53.00 1346	5.00 127					3.00 76					31 14
M110012	2	4.00 102	11.00 279	30.00 762	36.00 914	4.00 102	2.50 64	2.50 64			3.00 76			6:00	12:00	26 12
M110014	4	5.00 127	11.00 279	46.00 1168	51.75 1314	5.00 127	2.50 64				4.25 108	38.50 978	8.50 216	6:00	12:00	45 20
M110077	2	5.00 127	11.00 279	44.00 1118	50.00 1270	5.00 127	2.50 64	2.50 64			3.00 76			6:00	12:00	44 20
M110112	4	4.00 102	11.00 279	36.00 914	39.00 991	4.00 102	2.50 64				3.00 76	15.97 406	8.64 219	6:00	9:00	29 13
M110148	4	4.00 102	11.00 279	36.00 914	39.00 991	4.00 102	2.50 64				3.00 76	17.25 438	8.64 219	6:00	12:00	29 13
M110189	2	4.00 102	11.00 279	36.00 914	41.25 1048	4.00 102	2.50 64	2.50 64			2.63 67			6:00	12:00	34 15
M110311	4	4.00 OD 102	11.00 279	36.00 914	41.00 1041	4.00 102	2.50 64				5.00 127	27.10 688	8.64 219	6:00	12:00	27 12
M110479	3	4.00 102	11.00 279	36.00 914	39.00 991	4.00 102		2.50 64	4.25 108	8.64 219				6:00	3:00	31 14
M110674 ⁶	3	4.00 102	11.00 279	33.00 838	36.00 914	4.00 102			3.75 95	8.64 219				6:00		27 12
M110849	1	5.00 127	11.00 279	50.50 1283	57.00 1448	5.00 127					3.00 76					48 22
M111024	3	4.00 102	11.00 279	36.00 914	44.59 1133	Down Spout			3.75 95	8.64 219				12:00	6:00	34 15
M111025	4	4 OD 102 OD	11.00 279	36.00 914	41.00 1041	4 OD 102 OD					5.00 127	19.66 499	10.50 267		6:00	27 12
M111026	6	4.00 102	11.00 279	36.00 914	36.00 914	4 OD 102 OD			3.75 95	8.64 219		9.23 234	9.50 241	12:00	9:00	29 13
M111028	2	4 OD 102 OD	11.00 279	36.00 914	44.00 1118	5.00 127		2.50 64			5.00 127			12:00		36 16
M111029	1	3.00 76	11.00 279	36.00 914	42.00 1067	4.00 102					3.00 76					34 15
M120100	2	4.00 102	10 x15 254 x 381	26.00 660	32.50 826	4.00 102	4.25 108	4.25 108			3.25 83			3:00	9:00	30 14
M120108	2	5.00 127	10 x15 254 x 381	26.00 660	32.50 826	5.00 127	3.12 79	3.12 79			3.25 83			3:00	9:00	34 15
M120131	5	5.00 127	10 x15 254 x 381	26.00 660	29.39 747	5.00 127	3.12 79	3.12 79			3.25 83			3:00	9:00	32 15
M120135	4	4.00 102	10 x15 254 x 381	21.88 556	24.75 629	4.00 102	4.25 108				2.88 73	7.25 184	9.80 249	3:00	9:00	25 11
M120154	5	4.00 102	10 x15 254 x 381	26.00 660	28.38 721	4.00 102	4.25 108	4.25 108			2.25 57			3:00	9:00	31 14
M120176	5	5.00 127	10 x15 254 x 381	26.25 667	29.38 746	5.00 127	3.12 79	3.12 79			3.00 76			3:00	9:00	29 13
M120189	5	5.00 127	10 x15 254 x 381	33.38 848	39.50 1003	5.00 127	3.59 91	3.59 91			4.44 113			3:00	9:00	46 21
M120197 ¹	2	4.00 102	10.3 x15.3 261 x 389	36.00 914	42.00 1067	4.00 102	4.25 108	0.50 13			3.00 76			3:00	9:00	58 26
M120225	2	5.00 127	10 x15 254 x 381	26.00 660	32.50 826	5.00 127	3.12 79	3.12 79			3.25 86			3:00	9:00	31 14

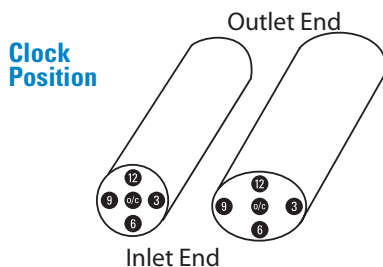

Footnotes

- 1 Wrapped muffler (reduces noise and surface temperature)
- 2 Stainless Steel
- 3 Silent Partner™ Muffler -Aluminized
- 4 Silent Partner™ Muffler -Stainless Steel
- 5 Resonator
- 6 Band clamp on inlet tube
- 7 Face flange on inlet
- 8 Made for off-road use
- 9 Made for off-road use, flows in either direction

Muffler Specifications by Part Number

MUFFLER SPECS

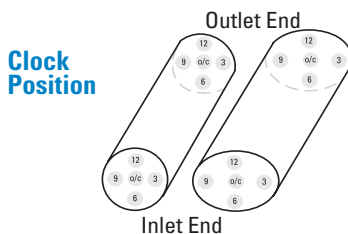
Part Number	Muffler Style	Body				Outlet I.D. (E)	Offset		Inlet Tube			Outlet Tube from End Center		Clock Position		Wgt lbs. kg
		Inlet I.D. (A)	Dia. (B) or (BxO)	Length (C)	Overall Length (D)		Inlet (F)	Outlet (G)	Loc. (H)	Length (I)	Length (J)	End Center (K)	Center (L)	Inlet	Outlet	
M120235	3	5.00 127	10 x15 254 x 381	35.87 911	39.87 1013	5.00 127	3.12 79	6.13 153	8.00 203					6:00	9:00	39 18
M120365	2	5.00 127	10 x15 254 x 381	36.00 914	42.50 1080	5.00 127	3.12 79	3.12 79		3.25 83				6:00	12:00	44 20
M120366	4	5.00 127	10 x15 254 x 381	36.00 914	39.25 997	5.00 127	3.12 79			3.12 79	28.38 721	9.50 241		3:00	9:00	48 22
M120367	4	4.00 102	10 x15 254 x 381	30.38 772	34.00 864	4.00 102	4.25 108			3.50 89	22.88 581	10.50 267		3:00	9:00	32 15
M120382	3	4.00 102	10 x15 254 x 381	15.00 381	21.57 548	3.85 OD 98 OD	4.40 112	3.25 83	10.80 274					9:00	9:00	18 8
M120147	4	5.00 127	10 x15 254 x 381	28.00 711	32.00 813	5.00 127	3.12 79			4.00 102	5.00 127	8.00 203		3:00	12:00	32.4 15
M120418	6	5.00 127	10 x15 254 x 381	28.00 711	28.25 718	5.00 127		5.00 127	8.00 203		5.00 127	8.00 203		6:00	12:00	27 12
M120448	2	5.00 127	10 x15 254 x 381	44.00 1118	50.00 1270	5.00 127	3.59 91	3.59 91		3.00 76				3:00	9:00	50 23
M120450	5	5.00 127	10 x15 254 x 381	44.00 1118	47.38 1203	5.00 127	3.59 91	3.59 91		3.25 83				3:00	9:00	46 21
M120566	3	4.00 102	10 x15 254 x 381	21.00 533	25.25 641	5.00 127	4.25 108	3.13 80	10.80 274					3:00	3:00	25 11
M120598	3	4.00 102	11.84 301	32.13 816	35.50 902	5.00 127		4.50 114	11.02 280					6:00		30 14
M120713	5	4.00 102	10 x15 254 x 381	27.00 686	31.13 791	5.00 127	4.40 112	4.25 108		4.00 102				3:00	9:00	31 14
M120747 ⁶	1	5.00 127	11.84 301	25.75 654	34.00 864	5.00 127				4.12 105						26.7 12
M120748 ⁸	2	5.00 127	11.84 301	25.75 654	34.00 864	5.00 127	2.81 71	2.81 71		4.12 105				6:00	12:00	26.7 12
M120749 ⁹	3/4	5.00 127	11.84 301	25.75 654	31.69 805	5.00 127			4.88 124	8.75 222				6:00		27.5 12.5
M120750 ⁸	5	5.00 127	11.84 301	25.75 654	31.69 805	5.00 127	2.81 71	2.81 71		4.12 105				6:00	12:00	28.7 13
M120751 ⁸	6	5.00 127	11.84 301	25.50 648	29.14 740	5.00 127			4.75 121	8.75 222	4.75 121	8.75 222		6:00	12:00	26.4 12
M122300	2	6.00 152	10 x15 254 x 381	31.75 806	42.50 1080	6.00 152	3.59 91	3.59 91		5.38 137				3:00	9:00	43 20
M140048	2	6.00 152	12 x18 305 x 457	30.00 762	38.00 965	6.00 152	4.50 114	4.50 114		4.00 102				3:00	9:00	50 23
M170101	2	6.00 152	14 x21 357 x 533	35.00 889	47.00 1194	6.00 152	5.25 133	5.25 133		6.00 152				3:00	9:00	89 40



Footnotes

- 1 Wrapped muffler (reduces noise and surface temperature)
- 2 Stainless Steel
- 3 Silent Partner™ Muffler -Aluminized
- 4 Silent Partner™ Muffler -Stainless Steel
- 5 Resonator
- 6 Band clamp on inlet tube
- 7 Face flange on inlet
- 8 Made for off-road use
- 9 Made for off-road use, flows in either direction

Style 1 - End Inlet /End Outlet /On Center

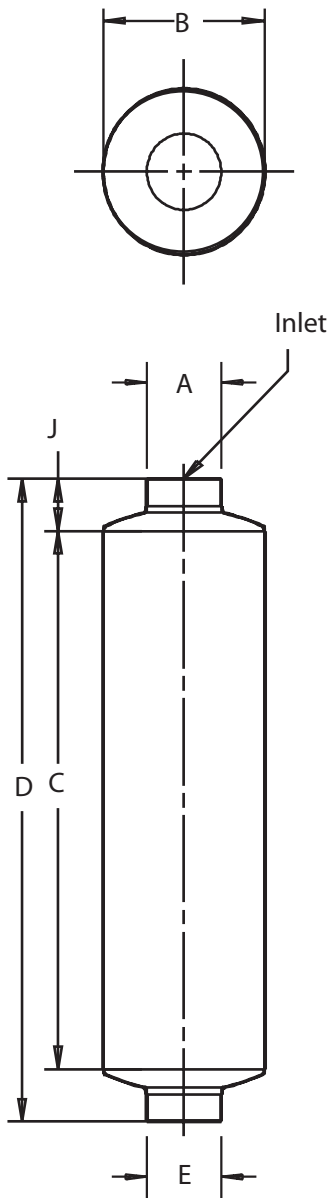

Part Number	Muffler Style	Body				Outlet I.D. (E)	Inlet Tube Length (J)	Wgt lbs. kg
		Inlet I.D. (A)	Dia. (B) or (BxO)	Length (C)	Overall Length (D)			
M060247	1	2 NPT	6.00 152	14.50 368	20.00 508	2 NPT	2.75 70	7 3
M060005	1	2.5 NPT	6.00 152	15.00 381	18.12 460	2.5 NPT	1.56 40	9 4
M070008	1	3 NPT	7.00 178	14.00 356	19.75 502	3 NPT	2.38 60	13 6
M070050	1	3.5 NPT	7.00 178	18.38 467	25.62 651	3.5 NPT	3.00 76	18 8
M090009	1	4 NPT	9.00 229	20.00 508	26.00 660	4 NPT	3.00 76	23 10
M045237	1	2.00 51	4.38 111	12.50 318	17.00 432	2.10 OD 53 OD	2.50 64	4 2
M060479 ⁸	1	2.00 51	6.00 152	15.75 400	21.00 533	2.00 51	2.62 67	7.6 3.4
M065071	1	2.50 64	6.62 168	15.00 381	22.00 559	2.60 OD 66 OD	3.50 89	7 3
M065138 ⁸	1	2.50 64	6.62 168	17.75 451	24.00 610	2.50 64	3.12 79	9.8 4.5
M085293	1	2.89 ⁷ 73 ⁷	8.50 216	31.75 806	46.25 1175	3.16 OD 80 OD		28 12
M085407 ⁸	1	3.00 76	8.50 216	19.75 502	26.50 673	3.00 76	3.38 86	15.2 7
M080018	1	3.00 76	8.00 203	12.18 309	17.00 432	3.13 OD 80 OD	1.38 35	10 5
M111029	1	3.00 76	11.00 279	36.00 914	42.00 1067	4.00 102	3.00 76	34 15
M070028	1	3.50 89	7.00 178	14.00 356	19.75 502	3.50 89	2.38 60	10 5
M090146	1	3.50 89	9.00 229	44.50 1130	51.00 1295	3.50 89	3.00 76	32 15
M091046 ⁸	1	3.50 89	9.00 229	21.75 552	29.00 737	3.50 89	3.62 89	15.8 7.2
M085171	1	4.00 102	8.50 216	34.37 873	40.00 1016	4.00 102	2.50 64	21 10
M085421	1	4.00 102	8.50 216	34.37 873	40.00 1016	4.00 102	2.50 64	21 10
M090095	1	4.00 ⁷ 102 ⁷	9.00 229	29.31 744	73.00 1854	4 OD 102 OD		33 15
M090362 ⁵	1	4.00 102	9.00 229	10.00 254	16.50 419	4.00 102	3.00 76	9 4
M090544	1	4.00 102	9.00 229	44.44 1129	51.00 1295	4.00 102	3.00 76	27 12
M090594	1	4.00 102	9.00 229	20.00 508	26.50 673	4.00 102	3.00 76	14 6
M090781	1	4.00 102	9.00 229	44.44 1129	51.00 1295	5.00 127	3.00 76	30 14
M100464 ¹	1	4.00 102	10.33 262	44.50 1130	51.00 1295	4.00 102	3.00 76	52 24
M100466	1	4.00 102	10.00 254	44.44 1129	51.00 1295	4.00 102	3.00 76	27 12
M100695	1	4.00 102	10.00 254	44.44 1129	51.00 1295	5.00 127	3.00 76	30 14
M101167 ⁸	1	4.00 102	10.00 254	23.75 603	32.00 813	4.00 102	4.12 105	19.3 8.8

Muffler Specifications by Style & Inlet Size

Style 1 - End Inlet /End Outlet /On Center

MUFFLER SPECS

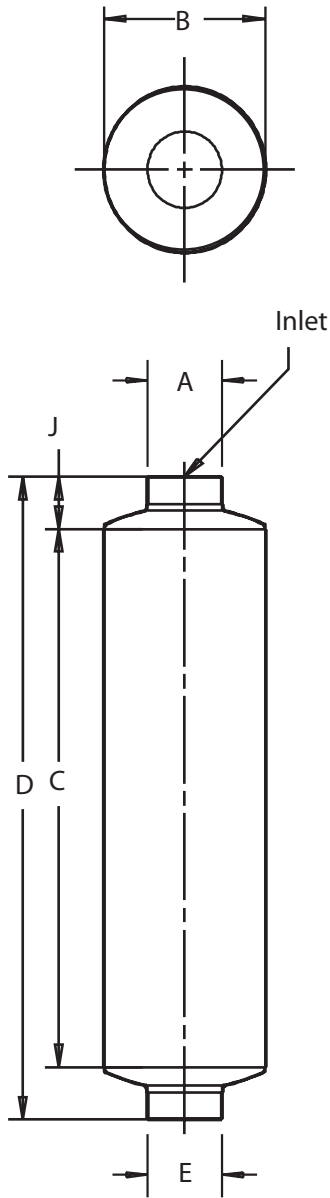

Part Number	Muffler Style	Body				Outlet I.D. (E)	Inlet Tube Length (J)	Wgt lbs. kg
		Inlet I.D. (A)	Dia. (B) or (BxO)	Length (C)	Overall Length (D)			
M090072 ⁵	1	5.00 127	9.00 229	10.00 254	16.50 419	5.00 127	3.00 76	9 4
M090074	1	5.00 127	9.00 229	44.44 1129	51.00 1295	5.00 127	3.00 76	29 13
M090535	1	5.00 127	9.00 229	44.44 1129	51.00 1295	5.00 127	3.00 76	30 14
M090595	1	5.00 127	9.00 229	20.00 508	26.50 673	5.00 127	3.00 76	15 7
M100463	1	5.00 127	10.00 254	44.44 1129	51.00 1295	5.00 127	3.00 76	31 14
M100465	1	5.00 127	10.00 254	44.44 1129	51.00 1295	5.00 127	3.00 76	28 13
M100580	1	5.00 127	10.00 254	44.44 1129	51.00 1295	5.00 127	3.00 76	29 13
M100582	1	5.00 127	10.00 254	44.44 1129	51.00 1295	5.00 127	3.00 76	31 14
M100807	1	5.00 127	10.00 254	59.94 1522	66.50 1689	5.00 127	3.00 76	48 22
M100944	1	5.00 127	10.00 254	44.44 1129	51.00 1295	5.00 127	3.00 76	32 15
M101158 ⁴	1	5.00 127	10.00 254	44.44 1129	51.00 1295	5.00 127	3.00 76	43 20
M101159 ⁴	1	5.00 127	10.00 254	44.44 1129	51.00 1295	5.00 127	3.00 76	43 20
M101181 ³	1	5.00 127	10.00 254	44.44 1129	51.00 1295	5.00 127	3.00 76	43 20
M101182 ³	1	5.00 127	10.00 254	44.44 1129	51.00 1295	5.00 127	3.00 76	43 20
M101263	1	5.00 127	10.00 254	44.44 1129	53.00 1346	5.00 127	3.00 76	31 14
M110849	1	5.00 127	11.00 279	50.50 1283	57.00 1448	5.00 127	3.00 76	48 22
M120747 ⁸	1	5.00 127	11.84 301	25.75 654	34.00 864	5.00 127	4.12 105	26.7 12

Style 2 and 2A on pages 70 and 71

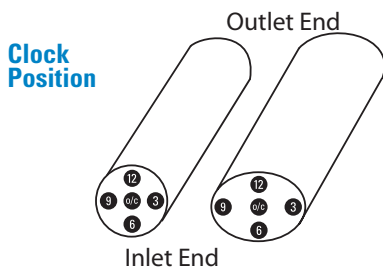

Footnotes

- 1 Wrapped muffler (reduces noise and surface temperature)
- 2 Stainless Steel
- 3 Silent Partner™ Muffler -Aluminized
- 4 Silent Partner™ Muffler -Stainless Steel
- 5 Resonator
- 6 Band clamp on inlet tube
- 7 Face flange on inlet
- 8 Made for off-road use
- 9 Made for off-road use, flows in either direction

Style 3 - Side Inlet /End Outlet

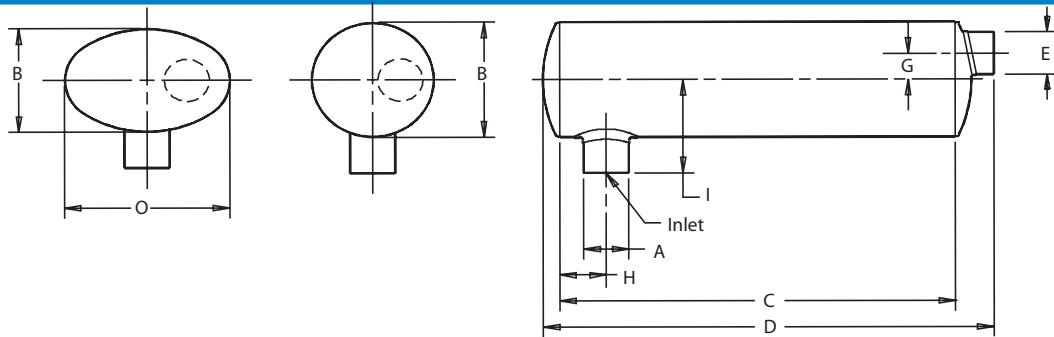

Part Number	Muffler Style	Body				Outlet I.D. (E)	Offset		Inlet Tube			Outlet Tube from End Center		Clock Position		Wgt lbs. kg
		Inlet I.D. (A)	Dia. (B) or (BxO)	Length (C)	Overall Length (D)		Inlet (F)	Outlet (G)	Loc. (H)	Length (I)	Length (J)	Inlet (K)	Outlet (L)	Inlet	Outlet	
M045193	3	1.68 43	4.38 111	13.78 350	15.78 401	1.64 42		2.75 70	4.00 102					12:00		4 2
M060158	3	2.00 51	6.00 152	18.81 478	21.50 546	2.00 51	1.50 38	3.50 89	5.00 127					3:00	6:00	9 4
M060481 ⁹	3/4	2.00 51	6.00 152	15.75 400	19.25 489	2.00 51		1.88 48	5.00 127					6:00		7.6 3.4
M065044	3	2.50 64	6.62 168	20.89 531	23.50 597	2.50 64	1.62 41	3.50 89	6.00 152					6:00	9:00	12 5
M065140 ⁹	3/4	2.50 64	6.62 168	17.75 451	22.04 560	2.50 64		2.38 60	5.75 146					6:00		10 4.5
M085084	3	3.50 89	8.50 216	27.00 686	29.50 749	3.00 76	2.00 51	4.50 114	7.25 184					3:00	6:00	20 9
M085090	3	3.02 77	8.50 216	26.25 667	29.50 749	3.00 76	2.00 51	3.50 89	6.75 171					3:00	6:00	20 9
M085226 ¹	3	3.00 76	8.80 224	27.12 689	29.56 751	3.00 76	2.00 51	4.56 116	6.75 171					3:00	6:00	28 13
M085409 ⁹	3/4	3.00 76	8.50 216	19.75 502	24.27 616	3.00 76		2.88 73	6.50 165					6:00		15.4 7
M090301	3	3.50 89	8.3 x 11.5 211 x 292	26.13 664	29.25 743	3.50 89	2.50 64	3.25 83	7.00 178					6:00	9:00	23 10
M090823	3	4.00 102	9.00 229	44.50 1130	48.00 1219	5.00 127		3.81 97	6.69 170					6:00		30 13
M091048 ⁹	3/4	3.50 89	9.00 229	21.75 552	26.38 670	3.50 89		3.38 86	7.25 184					6:00		15.9 7.2
M100146	3	4.00 102	10.00 254	28.00 711	32.00 813	4.00 102	2.44 62	4.50 114	8.00 203					6:00	9:00	27 12
M100213	3	5.00 127	10.00 254	44.50 1130	48.00 1219	5.00 127		5.50 140	7.50 191					6:00		33 15
M101169 ⁹	3/4	4.00 102	10.00 254	23.75 603	29.24 743	4.00 102		3.88 99	8.00 203					6:00		19.8 9
M110479	3	4.00 102	11.00 279	36.00 914	39.00 991	4.00 102	2.50 64	4.25 108	8.64 219					6:00	3:00	31 14
M110674 ⁶	3	4.00 102	11.00 279	33.00 838	36.00 914	4.00 102		3.75 95	8.64 219					6:00		27 12
M111024	3	4.00 102	11.00 279	36.00 914	44.59 1133	Down Spout		3.75 95	8.64 219					12:00	6:00	34 15
M120235	3	5.00 127	10 x 15 254 x 381	35.87 911	39.87 1013	5.00 127	3.12 79	6.13 153	8.00 203					6:00	9:00	39 18
M120382	3	4.00 102	10 x 15 254 x 381	15.00 381	21.57 548	3.85 OD 98 OD	4.40 112	3.25 83	10.80 274					9:00	9:00	18 8
M120566	3	4.00 102	10 x 15 254 x 381	21.00 533	25.25 641	5.00 127	4.25 108	3.13 80	10.80 274					3:00	3:00	25 11
M120598	3	4.00 102	11.84 301	32.13 816	35.50 902	5.00 127		4.50 114	11.02 280					6:00		30 14
M120749 ⁹	3/4	5.00	11.84	25.75	31.69	5.00		4.88	8.75					6:00		27.5

Muffler Specifications by Style & Inlet Size

MUFFLER SPECS

Style 2 - End Inlet /End Outlet /Offset and Style 2A - Dual End Inlet /End Outlet

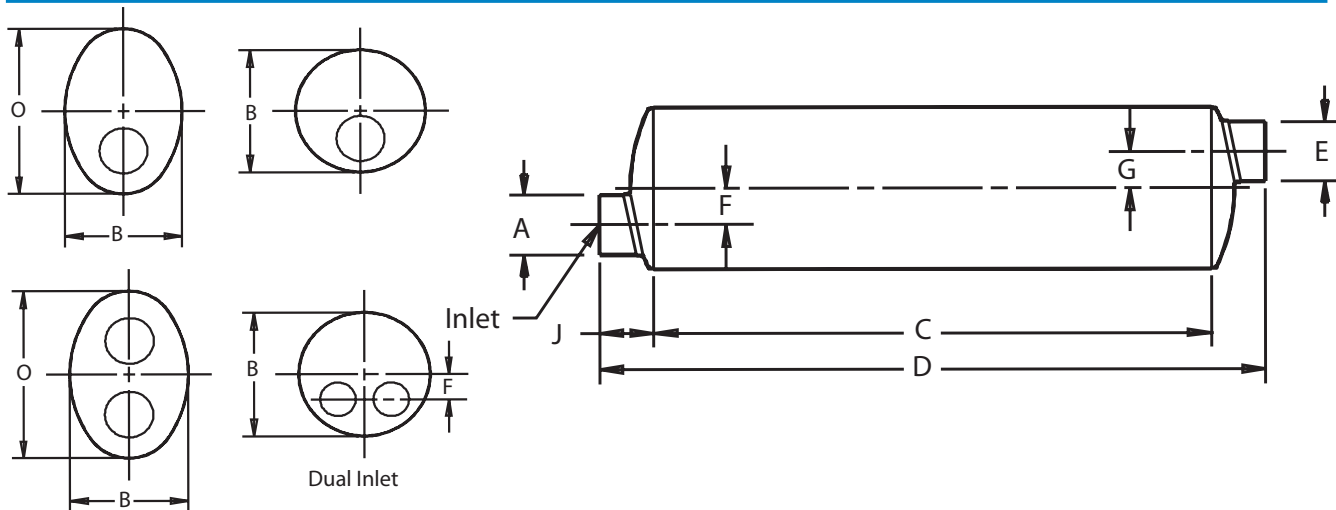

Part Number	Muffler Style	Body				Outlet I.D. (E)	Offset		Inlet Tube			Outlet Tube from End Center (K)	Clock Position		Wgt lbs. kg
		Inlet I.D. (A)	Dia. (B) or (BxO)	Length (C)	Overall Length (D)		Inlet (F)	Outlet (G)	Loc. (H)	Length (I)	Length (J)		Inlet	Outlet	
M060055	2	2.00 51	6.00 152	16.90 429	21.90 556	2.00 51	1.50 38	1.50 38		2.50 64			6:00	12:00	7 3
M060232	2	2.00 51	6.00 152	24.00 610	29.00 737	2.00 51	1.50 38	1.50 38		2.50 64			6:00	12:00	9 4
M060480 ⁸	2	2.00 51	6.00 152	15.75 400	21.00 533	2.00 51	1.50 38	1.50 38		2.62 67			6:00	12:00	7.6 3.4
M065034	2	2.50 64	6.62 168	18.56 471	23.00 584	2.50 64	1.62 41	1.62 41		1.50 38			6:00	12:00	9 4
M065139 ⁸	2	2.50 64	6.62 168	17.75 451	24.00 610	2.50 64	1.62 41	1.62 41		3.12 79			6:00	12:00	9.8 4.5
M085172	2A	2.50 (2) 64 (2)	8.50 216	30.00 762	39.00 991	2.75 70	1.62 (2) 41 (2)	2.00 51		2.50 (2) 64 (2)			6:00(2)	6:00	24 11
M085189 ²	2A	2.50 (2) 64 (2)	8.50 216	31.25 794	36.25 921	3.00 76	1.62 (2) 41 (2)	2.00 51		2.50 (2) 64 (2)			6:00 (2)	12:00	23 10
M085267 ^{1,2}	2A	2.50 (2) ⁷ 64 (2) ⁷	8.75 222	30.12 765	38.97 990	3 OD 76 OD	1.62 (2) 41 (2)	2.00 51		5.72/3.22 146/82			6:00 (2)	12:00	32 15
M090563	2A	2.75 (2) 70 (2)	8.2 x11.5 208 x 292	27.00 686	32.75 832	4.00 102	0.15/4.00 9/102	2.50 64		2.63 (2) 67 (2)			9:00-3:00	3:00	22 10
M085023	2	3.00 76	8.50 216	31.25 794	36.25 921	3.00 76	2.00 51	2.00 51		2.50 64			6:00	12:00	19 9
M085056	2	3.00 76	8.50 216	20.50 521	25.00 635	3.00 76	2.00 51	2.00 51		1.50 38			6:00	12:00	14 6
M085078	2	3.00 76	8.50 216	27.50 699	32.00 813	3.00 76	2.00 51	2.00 51		1.50 38			6:00	12:00	20 9
M085080	2	3.00 76	8.50 216	27.75 705	33.75 857	3.00 76	2.00 51	2.00 51		3.50 89			6:00	6:00	20 9
M090159 ¹	2	3.00 76	8.5 x11.8 216 x 300	26.00 660	33.75 857	3.00 76	2.50 64	2.50 64		3.88 99			3:00	3:00	29 13
M090170	2	3.00 76	8.3 x11.5 211 x 292	26.00 660	33.75 857	3.00 76	2.50 64	2.50 64		3.88 99			3:00	3:00	20 9
M085408 ⁸	2	3.00 76	8.50 216	19.75 502	26.50 673	3.00 76	2.00 51	2.00 51		3.38 86			6:00	12:00	15.2 7
M085008	2	3.50 89	8.50 216	38.00 965	43.00 1092	3.00 76	1.75 44	2.00 51		2.50 64			6:00	12:00	23 10
M090158	2	3.50 89	8.3 x11.5 211 x 292	26.00 660	32.25 819	3.50 89	2.50 64	2.50 64		3.12 79			3:00	9:00	24 11
M090210 ¹	2	3.50 89	8.5 x11.8 216 x 300	26.00 660	32.25 819	3.50 89	2.50 64	2.50 64		3.12 79			3:00	9:00	34 15

Part Number	Muffler Style	Body				Outlet I.D. (E)	Offset			Inlet Tube			Outlet Tube from End Center (K) (L)	Clock Position		Wgt lbs. kg
		Inlet I.D. (A)	Dia. (B) or (BxO)	Length (C)	Overall Length (D)		Inlet (F)	Outlet (G)	Loc. (H)	Length (I)	Length (J)	Inlet		Outlet		
M090520	2	3.50 89	8.2 x11.5 208 x 292	26.00 660	32.25 819	4.00 102	2.50 64	2.50 64			3.12 79			3:00	9:00	21 10
M090680	2	3.50 89	8.2 x11.5 208 x 292	30.00 762	36.25 921	4.00 102	2.50 64	2.50 64			3.12 79			3:00	9:00	25 11
M091047 ⁸	2	3.50 89	9.00 229	21.75 552	29.00 737	3.50 89	2.10 53	2.10 53			3.62 89			6:00	12:00	15.8 7.2
M090280	2	4.00 102	8.2 x11.5 208 x 292	26.00 660	32.25 819	4.00 102	2.50 64	2.50 64			3.12 79			3:00	9:00	22 10
M090534	2	4.00 102	8.2 x11.5 208 x 292	26.00 660	33.75 857	4.00 102	2.50 64	2.50 64			3.88 99			3:00	9:00	26 12
M090538	2	4.00 102	8.2 x11.5 208 x 292	26.00 660	32.25 819	3.50 89	2.50 64	2.50 64			3.12 79			3:00	12:00	26 12
M100043	2	4.00 102	10.00 254	35.38 899	41.75 1060	4.00 102	2.44 62	2.44 62			2.88 73			6:00	12:00	32 15
M100048	2	4.00 102	10.00 254	27.12 689	33.50 851	4.00 102	2.44 62	2.44 62			2.88 73			6:00	12:00	27 12
M101168 ⁸	2	4.00 102	10.00 254	23.75 603	32.00 813	4.00 102	2.44 62	2.44 62			4.12 105			6:00	12:00	19.3 8.8
M110012	2	4.00 102	11.00 279	30.00 762	36.00 914	4.00 102	2.50 64	2.50 64			3.00 76			6:00	12:00	26 12
M110189	2	4.00 102	11.00 279	36.00 914	41.25 1048	4.00 102	2.50 64	2.50 64			2.63 67			6:00	12:00	34 15
M111028	2	4 OD 102 OD	11.00 279	36.00 914	44.00 1118	5.00 127		2.50 64			5.00 127				12:00	36 16
M120100	2	4.00 102	10 x15 254 x 381	26.00 660	32.50 826	4.00 102	4.25 108	4.25 108			3.25 83			3:00	9:00	30 14
M120197 ¹	2	4.00 102	10.3 x15.3 261 x 389	36.00 914	42.00 1067	4.00 102	4.25 108	0.50 13			3.00 76			3:00	9:00	58 26
M110077	2	5.00 127	11.00 279	44.00 1118	50.00 1270	5.00 127	2.50 64	2.50 64			3.00 76			6:00	12:00	44 20
M120108	2	5.00 127	10 x15 254 x 381	26.00 660	32.50 826	5.00 127	3.12 79	3.12 79			3.25 83			3:00	9:00	34 15
M120225	2	5.00 127	10 x15 254 x 381	26.00 660	32.50 826	5.00 127	3.12 79	3.12 79			3.25 86			3:00	9:00	31 14
M120365	2	5.00 127	10 x15 254 x 381	36.00 914	42.50 1080	5.00 127	3.12 79	3.12 79			3.25 83			6:00	12:00	44 20
M120448	2	5.00 127	10 x15 254 x 381	44.00 1118	50.00 1270	5.00 127	3.59 91	3.59 91			3.00 76			3:00	9:00	50 23
M120748 ⁸	2	5.00 127	11.84 301	25.75 654	34.00 864	5.00 127	2.81 71	2.81 71			4.12 105			6:00	12:00	26.7 12
M122300	2	6.00 152	10 x15 254 x 381	31.75 806	42.50 1080	6.00 152	3.59 91	3.59 91			5.38 137			3:00	9:00	43 20
M140048	2	6.00 152	12 x18 305 x 457	30.00 762	38.00 965	6.00 152	4.50 114	4.50 114			4.00 102			3:00	9:00	50 23
M170101	2	6.00 152	14 x21 357 x 533	35.00 889	47.00 1194	6.00 152	5.25 133	5.25 133			6.00 152			3:00	9:00	89 40
M190002	2	8.00 203	16 x24 406 x 607	45.00 1143	57.00 1448	8.00 203	6.00 152	6.00 152			6.00 152			3:00	3:00	124 56

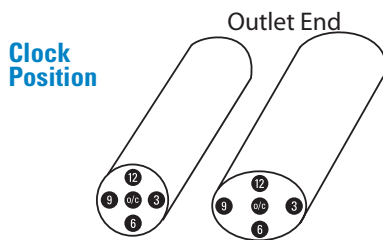

www.donaldson-filters.com

Footnotes

- 1 Wrapped muffler (reduces noise and surface temperature)
- 2 Stainless Steel
- 3 Silent Partner™ Muffler -Aluminized
- 4 Silent Partner™ Muffler -Stainless Steel
- 5 Resonator
- 6 Band clamp on inlet tube
- 7 Face flange on inlet
- 8 Made for off-road use
- 9 Made for off-road use, flows in either direction

Muffler Specifications by Style & Inlet Size

MUFFLER SPECS

Style 4 - End Inlet /Side Outlet

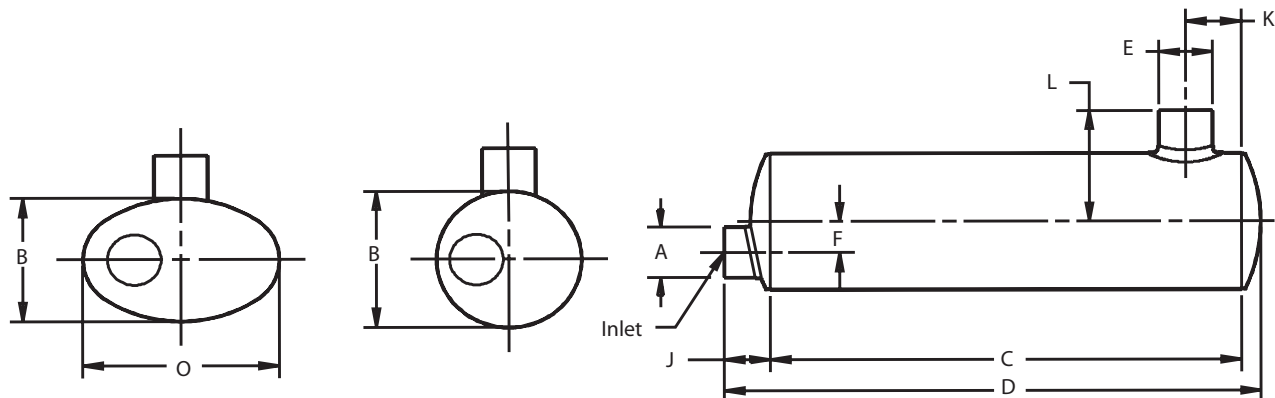

Part Number	Muffler Style	Body				Outlet I.D. (E)	Offset		Inlet Tube			Outlet Tube from End Center		Clock Position Inlet	Clock Position Outlet	Wgt lbs. kg
		Inlet I.D. (A)	Dia. (B) or (BxO)	Length (C)	Overall Length (D)		Inlet (F)	Outlet (G)	Loc. (H)	Length (I)	Length (J)	(K)	(L)			
		127	301	654	805	127			124	222						12.5
M060481 ⁹	3/4	2.00	6.00	15.75	19.25	2.00			1.88	5.00				6:00		7.6
		51	152	400	489	51			48	127						3.4
M065140 ⁹	3/4	2.50	6.62	17.75	22.04	2.50			2.38	5.75				6:00		10
		64	168	451	560	64			60	146						4.5
M085206	4	3.00	8.50	26.25	29.50	3.00	2.00				3.25	3.50	6.75	6:00	9:00	20
		76	216	667	749	76	51				83	89	171			9
M085409 ⁹	3/4	3.00	8.50	19.75	24.27	3.00			2.88	6.50				6:00		15.4
		76	216	502	616	76			73	165						7
M090547	4	3.50	8.2 x 11.5	32.56	35.16	4.00	2.50				2.60	20.48	6.00	9:00	7:00	22
		89	208 x 292	827	893	102	64				66	520	152			10
M090548	4	3.50	8.2 x 11.5	32.56	35.16	4 OD	2.50				2.60	20.48	8.70	3:00	7:30	21
		89	208 x 292	827	893	102 OD	64				66	520	221			10
M091048 ⁹	3/4	3.50	9.00	21.75	26.38	3.50			3.38	7.25				6:00		15.9
		89	229	552	670	89			86	184						7.2
M110052	4	4.00	10.00	27.75	30.75	4.00	2.44				3.00	24.25	8.75	6:00	2:00	25
		102	254	705	781	102	62				76	616	222			11
M110169 ⁹	3/4	4.00	10.00	23.75	29.24	4.00			3.88	8.00				6:00		19.8
		102	254	603	743	102			99	203						9
M110112	4	4.00	11.00	36.00	39.00	4.00	2.50				3.00	15.97	8.64	6:00	9:00	29
		102	279	914	991	102	64				76	406	219			13
M110148	4	4.00	11.00	36.00	39.00	4.00	2.50				3.00	17.25	8.64	6:00	12:00	29
		102	279	914	991	102	64				76	438	219			13
M120367	4	4.00	10 x 15	30.38	34.00	4.00	4.25				3.50	22.88	10.50	3:00	9:00	32
		102	254 x 381	772	864	102	108				89	581	267			15
M110311	4	4.00 OD	11.00	36.00	41.00	4.00	2.50				5.00	27.10	8.64	6:00	12:00	27
		102	279	914	1041	102	64				127	688	219			12
M111025	4	4 OD	11.00	36.00	41.00	4 OD					5.00	19.66	10.50		6:00	27
		102 OD	279	914	1041	102 OD					127	499	267			12
M110014	4	5.00	11.00	46.00	51.75	5.00	2.50				4.25	38.50	8.50	6:00	12:00	45
		127	279	1168	1314	127	64				108	978	216			20
M120366	4	5.00	10 x 15	36.00	39.25	5.00	3.12				3.12	28.38	9.50	3:00	9:00	48
		127	254 x 381	914	997	127	79				79	721	241			22
M120749 ⁹	3/4	5.00	11.84	25.75	31.69	5.00			4.88	8.75				6:00		27.5
		127	301	654	805	127			124	222						12.5

Style 5 - Inlet & Outlet on Same End

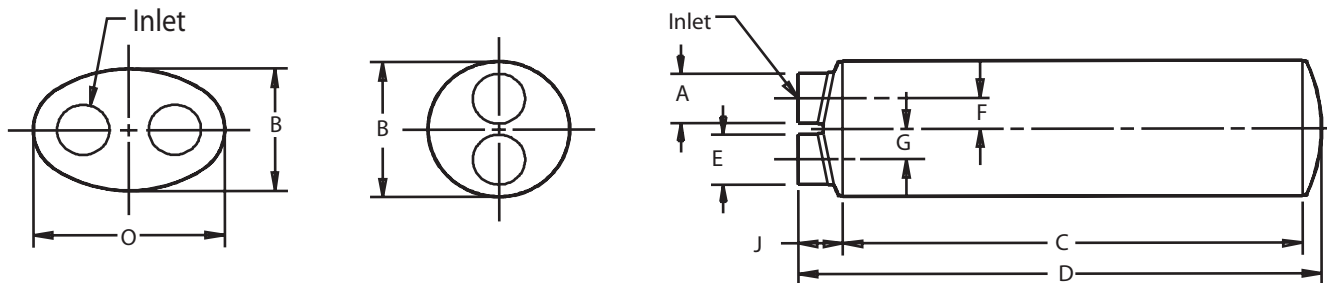

Part Number	Muffler Style	Body				Outlet I.D. (E)	Offset		Inlet Tube			Outlet Tube from End Center		Clock Position Inlet	Clock Position Outlet	Wgt lbs. kg
		Inlet I.D. (A)	Dia. (B) or (BxO)	Length (C)	Overall Length (D)		Inlet (F)	Outlet (G)	Loc. (H)	Length (I)	Length (J)	(K)	(L)			
M060250	5	2.00 51	6.00 152	16.90 429	19.40 493	2.00 51	1.50 38	1.50 38		2.50 64			6:00	12:00	8 4	
M060482 ⁸	5	2.00 51	6.00 152	15.75 400	19.25 489	2.00 51	1.50 38	1.50 38		2.62 67					8.4 3.8	
M065073	5	2.50 64	6.62 168	20.00 508	21.50 546	2.50 64	1.62 41	1.62 41		1.50 38			6:00	12:00	10 5	
M065141 ⁸	5	2.50 64	6.62 168	17.75 451	22.04 560	2.50 64	1.63 41	1.63 41		3.12 79			6:00	12:00	10.6 4.8	
M085207	5	3.00 76	8.50 216	22.00 559	23.50 597	3.00 76	2.00 51	2.00 51		1.50 38			6:00	12:00	16 7	
M085410 ⁸	5	3.00 76	8.50 216	19.75 502	24.27 616	3.00 76	2.00 51	2.00 51		3.38 86			6:00	12:00	17 7.7	
M091049 ⁸	5	3.50 89	9.00 229	21.75 552	26.44 672	3.50 89	2.10 53	2.10 53		3.62 89			6:00	12:00	17.3 7.9	
M100049	5	4.00 102	10.00 254	27.75 705	30.62 778	4.00 102	2.44 62	2.44 62		2.88 73			12:00	6:00	23 10	
M101170 ⁸	5	4.00 102	10.00 254	23.75 603	29.24 743	4.00 102	2.44 62	2.44 62		4.12 105			6:00	12:00	22 10	
M120154	5	4.00 102	10 x15 254 x 381	26.00 660	28.38 721	4.00 102	4.25 108	4.25 108		2.25 57			3:00	9:00	31 14	
M120713	5	4.00 102	10 x15 254 x 381	27.00 686	31.13 791	5.00 127	4.40 112	4.25 108		4.00 102			3:00	9:00	31 14	
M120131	5	5.00 127	10 x15 254 x 381	26.00 660	29.39 747	5.00 127	3.12 79	3.12 79		3.25 83			3:00	9:00	32 15	
M120176	5	5.00 127	10 x15 254 x 381	26.25 667	29.38 746	5.00 127	3.12 79	3.12 79		3.00 76			3:00	9:00	29 13	
M120189	5	5.00 127	10 x15 254 x 381	33.38 848	39.50 1003	5.00 127	3.59 91	3.59 91		4.44 113			3:00	9:00	46 21	
M120450	5	5.00 127	10 x15 254 x 381	44.00 1118	47.38 1203	5.00 127	3.59 91	3.59 91		3.25 83			3:00	9:00	46 21	
M120750 ⁸	5	5.00 127	11.84 301	25.75 654	31.69 805	5.00 127	2.81 71	2.81 71		4.12 105			6:00	12:00	28.7 13	

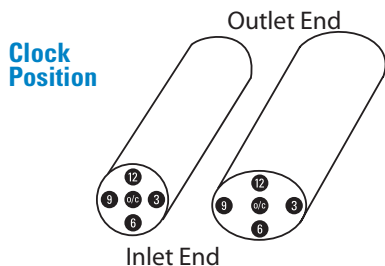

Footnotes

- 1 Wrapped muffler (reduces noise and surface temperature)
- 2 Stainless Steel
- 3 Silent Partner™ Muffler -Aluminized
- 4 Silent Partner™ Muffler -Stainless Steel
- 5 Resonator
- 6 Band clamp on inlet tube
- 7 Face flange on inlet
- 8 Made for off-road use
- 9 Made for off-road use, flows in either direction

Muffler Specifications by Style & Inlet Size

Style 6 - Side Inlet /Side Outlet

MUFFLER SPECS

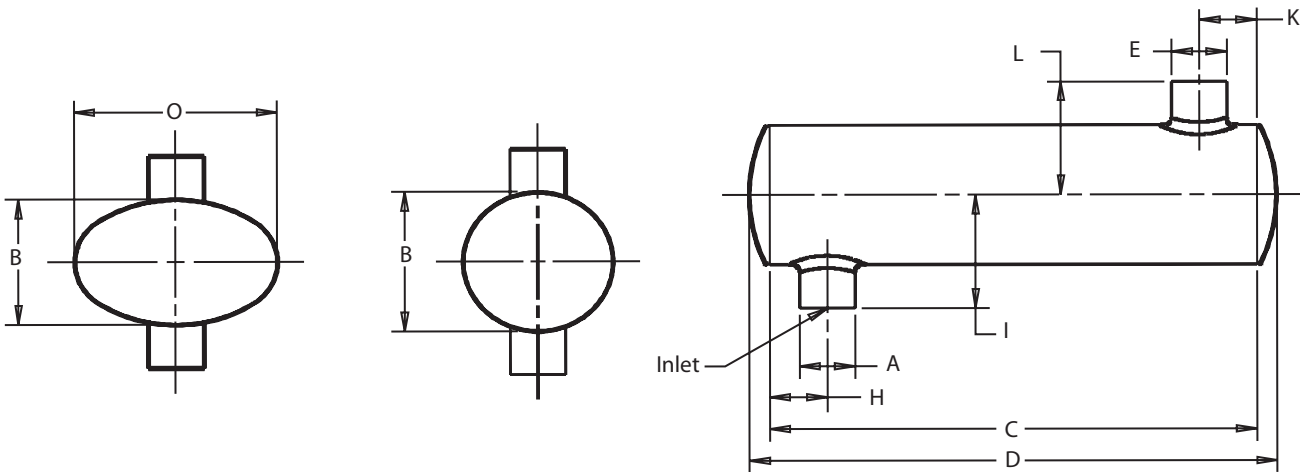

Part Number	Muffler Style	Body				Outlet I.D. (E)	Offset		Inlet Tube			Outlet Tube from End Center		Clock Position		Wgt lbs. kg
		Inlet I.D. (A)	Dia. (B) or (BxO)	Length (C)	Overall Length (D)		Inlet (F)	Outlet (G)	Loc. (H)	Length (I)	Length (J)	End Center (K)	End Center (L)	Inlet	Outlet	
M060251	6	2.00 51	6.00 152	18.81 478	18.81 478	2.00 51			3.50 89	5.00 127		3.50 89	5.00 127	6:00	12:00	8 4
M060483 ⁸	6	2.00 51	6.00 152	15.50 394	17.24 438	2.00 51			1.75 44	5.00 127		1.75 44	5.00 127	6:00	12:00	7.4 3.4
M065074	6	2.50 64	6.62 168	20.81 529	20.81 529	2.50 64			3.50 89	6.00 152		3.50 89	6.00 152	6:00	12:00	10 5
M065142 ⁸	6	2.50 64	6.62 168	17.50 444	19.84 504	2.50 64			2.50 64	5.75 146		2.25 57	5.75 146	6:00	12:00	9.4 4.2
M085208	6	3.00 76	8.50 216	27.00 686	27.00 686	3.00 76			3.50 89	6.75 171		3.50 89	6.75 171	6:00	12:00	17 8
M085411 ⁸	6	3.00 76	8.50 216	19.50 495	21.78 553	3.00 76			3.00 76	6.50 165		3.00 76	6.50 165	6:00	12:00	14.2 6.4
M090598	6	3.50 89	8.3 x 11.5 211 x 292	26.00 660	26.00 660	3.50 89			3.38 86	7.00 178		3.38 86	7.00 178	6:00	12:00	20 9
M091050 ⁸	6	3.50 89	9.00 229	21.50 546	23.64 600	3.50 89			3.25 83	7.25 184		3.25 83	7.25 184	6:00	12:00	15.1 6.9
M100572	6	4.00 102	10.12 257	28.00 711	30.62 778	4.00 102			4.50 114	8.00 203		4.50 114	8.00 203	6:00	12:00	22 10
M101171 ⁸	6	4.00 102	10.00 254	23.50 597	26.24 666	4.00 102			3.75 95	8.00 203		3.75 95	8.00 203	6:00	12:00	19.1 8.7
M111026	6	4.00 102	11.00 279	36.00 914	36.00 914	4 OD 102 OD			3.75 95	8.64 219		9.23 234	9.50 241	12:00	9:00	29 13
M120418	6	5.00 127	10 x 15 254 x 381	28.00 711	28.25 718	5.00 127			5.00 127	8.00 203		5.00 127	8.00 203	6:00	12:00	27 12
M120751 ⁸	6	5.00 127	11.84 301	25.50 648	29.14 740	5.00 127			4.75 121	8.75 222		4.75 121	8.75 222	6:00	12:00	26.4 12

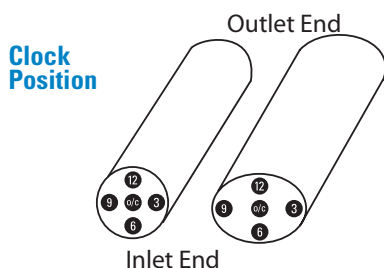

Footnotes

- 1 Wrapped muffler (reduces noise and surface temperature)
- 2 Stainless Steel
- 3 Silent Partner™ Muffler -Aluminized
- 4 Silent Partner™ Muffler -Stainless Steel
- 5 Resonator
- 6 Band clamp on inlet tube
- 7 Face flange on inlet
- 8 Made for off-road use
- 9 Made for off-road use, flows in either direction

Exhaust Configurations

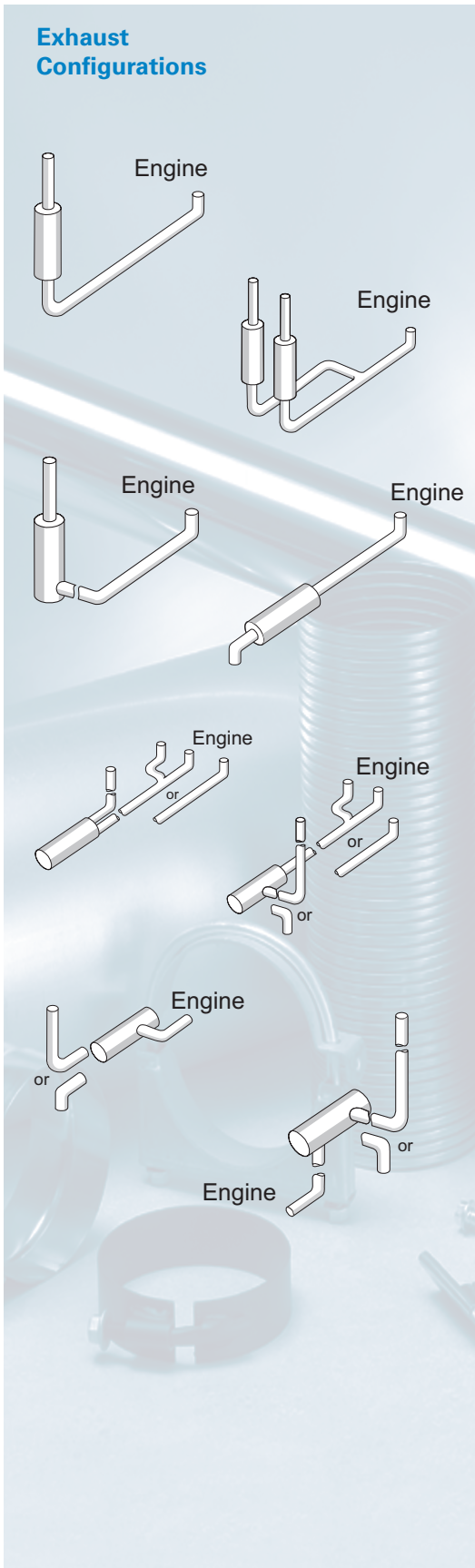

Types of Truck Exhaust Systems in this Section

This section will provide you with a series of muffler options for individual truck engines. The information is presented by engine manufacturer, exhaust system configuration, engine model and horsepower rating. Once you locate your engine, you'll be able to select from a variety of muffler sizes. In many cases, there are multiple choices for a particular application. To assist in your selection refer to the notes column.

Section Index

Truck Engine Models

Caterpillar 76	Detroit Diesel .96	International 102
3116	6-71T	6.9L
3176	6V-92T	7.3L (T444)
3306	6V-92TA	9.0L
3126B	6V-92TT	DT360
3306B	6V-92TTA	DT414
3406B	8.2T	DT420
3406E	8V-71T	DT466E
C-10	8V-71TA	DT812B
C-12	8V-71TT	DT817
C-15	8V-71TTA	DT817C
C-16	8V-92T	
	8V-92TA	Mack 107
Cummins 86	8V-92TT	E6
6BT	8V-92TTA	E7
6CT	Series 40E (7.6 LTA)	E9
ISB	Series 40E (8.7 LTA)	ENDT673
ISC	Series 50 (8.7 Ltr)	ENDT675
ISM	Series 60 (11.1 Ltr)	ENDT865
ISX	Series 60 (12.7 Ltr)	ENDT866
L10	Series 60 (14 Ltr)	
M11		
N14		
NTC		
Signature		

Muffler Selection Word of Caution!

Depending on your location, some diesel engines require the use of an emissions aftertreatment device to meet emissions regulations. In the United States, federal law prohibits the replacement of an emissions device (i.e., catalytic converter, combined catalytic converter/muffler, diesel particulate filter, etc.) with a non-emissions reducing (such as a straight pipe or conventional muffler) or unapproved emissions device. If operating the vehicle outside of the United States, make sure to check with and comply with any emission regulations for your locale.

Engine Make & Exhaust System Configuration	Engine Model	Engine H.P.	Muffler Dimensions						Backpressure		Muffler Style & Part No.	Notes
			inches			mm			inches of Hg	H ₂ O		

Caterpillar

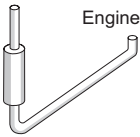

TRUCK ENGINE APPL.

3406B	350	4.0	9.0	5.0	102	229	127	2.3	31	1	M090781	
		5.0	9.0	5.0	127	229	127	1.9	26	1	M090074	
		5.0	9.0	5.0	127	229	127	1.0	14	1	M090535	Low backpressure, off-hwy
		5.0	10.0	5.0	127	254	127	1.0	14	1	M100463	Low backpressure, off-hwy
		5.0	10.0	5.0	127	254	127	2.1	28	1	M100465	Best value, most popular
		5.0	10.0	5.0	127	254	127	2.2	30	1	M100580	OE replacement
		5.0	10.0	5.0	127	254	127	2.4	32	1	M100807	60" (1524mm) Long Body
		5.0	10.0	5.0	127	254	127	1.7	24	1	M100944	OE replacement for higher HP
		5.0	10.0	5.0	127	254	127	2.1	29	1	M101158	Silent Partner Stainless
		5.0	10.0	5.0	127	254	127	2.1	29	1	M101181	Silent Partner Aluminized
		5.0	10.0	5.0	127	254	127	2.2	30	1	M101263	Freightliner only
		5.0	11.0	5.0	127	279	127	1.7	24	1	M110849	
3406B	400	4.0	9.0	5.0	102	229	127	2.8	38	1	M090781	
		5.0	9.0	5.0	127	229	127	2.4	32	1	M090074	
		5.0	9.0	5.0	127	229	127	1.3	17	1	M090535	Low backpressure, off-hwy
		5.0	10.0	5.0	127	254	127	1.3	17	1	M100463	Low backpressure, off-hwy
		5.0	10.0	5.0	127	254	127	2.5	34	1	M100465	Best value, most popular
		5.0	10.0	5.0	127	254	127	2.7	36	1	M100580	OE replacement
		5.0	10.0	5.0	127	254	127	2.9	39	1	M100807	60" (1524mm) Long Body
		5.0	10.0	5.0	127	254	127	2.1	29	1	M100944	OE replacement for higher HP
		5.0	10.0	5.0	127	254	127	2.6	35	1	M101158	Silent Partner Stainless
		5.0	10.0	5.0	127	254	127	2.6	35	1	M101181	Silent Partner Aluminized
		5.0	10.0	5.0	127	254	127	2.7	36	1	M101263	Freightliner only
		5.0	11.0	5.0	127	279	127	2.1	28	1	M110849	
3406B	425 to 460	5.0	9.0	5.0	127	229	127	2.5	35	1	M090074	
		5.0	9.0	5.0	127	229	127	1.4	18	1	M090535	Low backpressure, off-hwy
		5.0	10.0	5.0	127	254	127	1.4	18	1	M100463	Low backpressure, off-hwy
		5.0	10.0	5.0	127	254	127	2.7	37	1	M100465	Best value, most popular
		5.0	10.0	5.0	127	254	127	2.9	39	1	M100580	OE replacement
		5.0	10.0	5.0	127	254	127	2.3	31	1	M100944	OE replacement for higher HP
		5.0	10.0	5.0	127	254	127	2.8	38	1	M101158	Silent Partner Stainless
		5.0	10.0	5.0	127	254	127	2.8	38	1	M101181	Silent Partner Aluminized
		5.0	10.0	5.0	127	254	127	2.9	39	1	M101263	Freightliner only
		5.0	11.0	5.0	127	279	127	2.3	31	1	M110849	
C-12	335 to 355	4.0	9.0	5.0	102	229	127	1.9	25	1	M090781	
		5.0	9.0	5.0	127	229	127	1.6	21	1	M090074	
		5.0	9.0	5.0	127	229	127	0.8	11	1	M090535	Low backpressure, off-hwy
		5.0	10.0	5.0	127	254	127	0.8	11	1	M100463	Low backpressure, off-hwy
		5.0	10.0	5.0	127	254	127	1.7	23	1	M100465	Best value, most popular
		5.0	10.0	5.0	127	254	127	1.8	24	1	M100580	OE replacement
		5.0	10.0	5.0	127	254	127	1.9	26	1	M100807	60" (1524mm) Long Body
		5.0	10.0	5.0	127	254	127	1.4	19	1	M100944	OE replacement for higher HP
		5.0	10.0	5.0	127	254	127	1.7	23	1	M101158	Silent Partner Stainless
		5.0	10.0	5.0	127	254	127	1.7	23	1	M101181	Silent Partner Aluminized
5.0	10.0	5.0	127	254	127	1.8	24	1	M101263	Freightliner only		
5.0	11.0	5.0	127	279	127	1.4	19	1	M110849			
C-12	380	5.0	9.0	5.0	127	229	127	1.6	22	1	M090074	
		5.0	9.0	5.0	127	229	127	0.9	12	1	M090535	Low backpressure, off-hwy
		4.0	9.0	5.0	102	229	127	1.9	26	1	M090781	
		5.0	10.0	5.0	127	254	127	0.9	12	1	M100463	Low backpressure, off-hwy
		5.0	10.0	5.0	127	254	127	1.7	24	1	M100465	Best value, most popular
		5.0	10.0	5.0	127	254	127	1.8	25	1	M100580	OE replacement
		5.0	10.0	5.0	127	254	127	2.0	27	1	M100807	60" (1524mm) Long Body
		5.0	10.0	5.0	127	254	127	1.5	20	1	M100944	OE replacement for higher HP
		5.0	10.0	5.0	127	254	127	1.8	24	1	M101158	Silent Partner Stainless
		5.0	10.0	5.0	127	254	127	1.8	24	1	M101181	Silent Partner Aluminized
5.0	10.0	5.0	127	254	127	1.8	25	1	M101263	Freightliner only		
5.0	11.0	5.0	127	279	127	1.5	20	1	M110849			
C-12	395 to 430	4.0	9.0	5.0	102	229	127	2.1	28	1	M090781	
		5.0	9.0	5.0	127	229	127	1.8	24	1	M090074	
		5.0	9.0	5.0	127	229	127	0.9	13	1	M090535	Low backpressure, off-hwy
		5.0	10.0	5.0	127	254	127	0.9	13	1	M100463	Low backpressure, off-hwy
		5.0	10.0	5.0	127	254	127	1.9	25	1	M100465	Best value, most popular
		5.0	10.0	5.0	127	254	127	2.0	27	1	M100580	OE replacement
		5.0	10.0	5.0	127	254	127	2.1	29	1	M100807	60" (1524mm) Long Body
		5.0	10.0	5.0	127	254	127	1.6	21	1	M100944	OE replacement for higher HP
		5.0	10.0	5.0	127	254	127	1.9	26	1	M101158	Silent Partner Stainless
		5.0	10.0	5.0	127	254	127	1.9	26	1	M101181	Silent Partner Aluminized
5.0	10.0	5.0	127	254	127	2.0	27	1	M101263	Freightliner only		

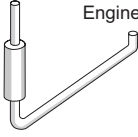
Engine Make & Exhaust System Configuration	Engine Model	H.P.	Muffler Dimensions inches			Muffler Dimensions mm			Backpressure inches of Hg / H ₂ O		Muffler Style & Part No.	Notes	
			Inlet	Body	Outlet	Inlet	Body	Outlet					
 Engine	C-15	355	5.0	11.0	5.0	127	279	127	1.6	21	1	M110849	
			4.0	9.0	5.0	102	229	127	2.3	32	1	M090781	
			5.0	9.0	5.0	127	229	127	2.0	27	1	M090074	
			5.0	9.0	5.0	127	229	127	1.1	14	1	M090535	Low backpressure, off-hwy
			5.0	10.0	5.0	127	254	127	1.1	14	1	M100463	Low backpressure, off-hwy
			5.0	10.0	5.0	127	254	127	2.1	29	1	M100465	Best value, most popular
			5.0	10.0	5.0	127	254	127	2.2	30	1	M100580	OE replacement
			5.0	10.0	5.0	127	254	127	2.4	33	1	M100807	60" (1524mm) Long Body
			5.0	10.0	5.0	127	254	127	1.8	24	1	M100944	OE replacement for higher HP
			5.0	10.0	5.0	127	254	127	2.1	29	1	M101158	Silent Partner Stainless
			5.0	10.0	5.0	127	254	127	2.1	29	1	M101181	Silent Partner Aluminized
			5.0	10.0	5.0	127	254	127	2.2	30	1	M101263	Freightliner only
			5.0	11.0	5.0	127	279	127	1.8	24	1	M110849	
C-15	375 to 435	5.0	9.0	5.0	127	229	127	1.4	20	1	M090535	Low backpressure, off-hwy	
		5.0	10.0	5.0	127	254	127	1.4	20	1	M100463	Low backpressure, off-hwy	
		5.0	10.0	5.0	127	254	127	2.9	39	1	M100465	Best value, most popular	
		5.0	10.0	5.0	127	254	127	2.9	40	1	M100580	OE replacement	
		5.0	10.0	5.0	127	254	127	2.4	33	1	M100944	OE replacement for higher HP	
		5.0	10.0	5.0	127	254	127	2.9	40	1	M101158	Silent Partner Stainless	
		5.0	10.0	5.0	127	254	127	2.9	40	1	M101181	Silent Partner Aluminized	
		5.0	10.0	5.0	127	254	127	2.9	40	1	M101263	Freightliner only	
		5.0	11.0	5.0	127	279	127	2.4	33	1	M110849		
C-15	455 to 500	5.0	9.0	5.0	127	229	127	1.7	23	1	M090535	Low backpressure, off-hwy	
		5.0	10.0	5.0	127	254	127	1.7	23	1	M100463	Low backpressure, off-hwy	
		5.0	10.0	5.0	127	254	127	2.8	38	1	M100944	OE replacement for higher HP	
		5.0	11.0	5.0	127	279	127	2.8	38	1	M110849		
C-16	575	5.0	9.0	5.0	127	229	127	1.8	24	1	M090535	Low backpressure, off-hwy	
		5.0	10.0	5.0	127	254	127	1.8	24	1	M100463	Low backpressure, off-hwy	
		5.0	10.0	5.0	127	254	127	2.9	40	1	M100944	OE replacement for higher HP	
		5.0	11.0	5.0	127	279	127	2.9	40	1	M110849		
C-16	600	5.0	9.0	5.0	127	229	127	1.8	25	1	M090535	Low backpressure, off-hwy	
		5.0	10.0	5.0	127	254	127	1.8	25	1	M100463	Low backpressure, off-hwy	
3406E	355 to 435	4.0	9.0	5.0	102	229	127	3.0	40	1	M090781		
		5.0	9.0	5.0	127	229	127	2.5	34	1	M090074		
		5.0	9.0	5.0	127	229	127	1.3	18	1	M090535	Low backpressure, off-hwy	
		5.0	10.0	5.0	127	254	127	1.3	18	1	M100463	Low backpressure, off-hwy	
		5.0	10.0	5.0	127	254	127	2.7	36	1	M100465	Best value, most popular	
		5.0	10.0	5.0	127	254	127	2.8	38	1	M100580	OE replacement	
		5.0	10.0	5.0	127	254	127	2.2	30	1	M100944	OE replacement for higher HP	
		5.0	10.0	5.0	127	254	127	2.7	37	1	M101158	Silent Partner Stainless	
		5.0	10.0	5.0	127	254	127	2.7	37	1	M101181	Silent Partner Aluminized	
		5.0	10.0	5.0	127	254	127	2.8	38	1	M101263	Freightliner only	
		5.0	11.0	5.0	127	279	127	2.2	30	1	M110849		
3406E	455 to 500	5.0	9.0	5.0	127	229	127	1.7	23	1	M090535	Low backpressure, off-hwy	
		5.0	10.0	5.0	127	254	127	1.7	23	1	M100463	Low backpressure, off-hwy	
		5.0	10.0	5.0	127	254	127	2.8	38	1	M100944	OE replacement for higher HP	
		5.0	11.0	5.0	127	279	127	2.8	38	1	M110849		
3406E	575	5.0	9.0	5.0	127	229	127	1.8	25	1	M090535	Low backpressure, off-hwy	
		5.0	10.0	5.0	127	254	127	1.8	25	1	M100463	Low backpressure, off-hwy	
3406E	600	5.0	9.0	5.0	127	229	127	1.8	25	1	M090535	Low backpressure, off-hwy	
		5.0	10.0	5.0	127	254	127	1.8	25	1	M100463	Low backpressure, off-hwy	
3406B	350 to 400	4.0	9.0	4.0	102	229	102	1.2	16	1	M090544		
		4.0	10.0	4.0	102	254	102	1.2	17	1	M100466		
		4.0	10.0	5.0	102	254	127	2.0	27	1	M100695		
		4.0	10.3	4.0	102	262	102	2.3	31	1	M100464	Wrapped muffler	
		5.0	10.0	5.0	127	254	127	1.5	20	1	M100582	OE replacement	
		5.0	10.0	5.0	127	254	127	1.5	20	1	M101159	Silent Partner Stainless	
		5.0	10.0	5.0	127	254	127	1.5	20	1	M101182	Silent Partner Aluminized	
		5.0	10.0	5.0	127	254	127	1.5	20	1	M101182	Silent Partner Aluminized	
3406B	425 to 460	4.0	9.0	4.0	102	229	102	1.3	18	1	M090544		
		4.0	10.0	4.0	102	254	102	1.4	19	1	M100466		
		4.0	10.0	5.0	102	254	127	2.2	30	1	M100695		
		4.0	10.3	4.0	102	262	102	2.6	35	1	M100464	Wrapped muffler	
		5.0	10.0	5.0	127	254	127	1.7	23	1	M100582	OE replacement	
		5.0	10.0	5.0	127	254	127	1.7	23	1	M101159	Silent Partner Stainless	
		5.0	10.0	5.0	127	254	127	1.7	23	1	M101182	Silent Partner Aluminized	
C-12	335 to 355	4.0	9.0	4.0	102	229	102	0.8	10	1	M090544		
		4.0	10.0	4.0	102	254	102	0.8	11	1	M100466		
		4.0	10.0	5.0	102	254	127	1.3	18	1	M100695		

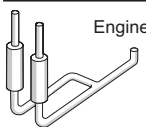

Truck Engine Muffler Application

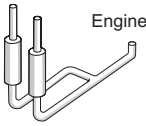

TRUCK ENGINE APPL.

Engine Make & Exhaust System Configuration	Engine Model	Engine H.P.	Muffler Dimensions inches			Muffler Dimensions mm			Backpressure inches of Hg		Muffler Style & Part No.	Notes	
			Inlet	Body	Outlet	Inlet	Body	Outlet	Hg	H ₂ O			
 Engine	C-12	380 to 430	4.0	10.3	4.0	102	262	102	1.5	21	1	M100464	Wrapped muffler
			5.0	10.0	5.0	127	254	127	1.0	14	1	M100582	OE replacement
			5.0	10.0	5.0	127	254	127	1.0	14	1	M101159	Silent Partner Stainless
			5.0	10.0	5.0	127	254	127	1.0	14	1	M101182	Silent Partner Aluminized
	C-15	355	4.0	9.0	4.0	102	229	102	0.9	12	1	M090544	
			4.0	10.0	4.0	102	254	102	0.9	12	1	M100466	
			4.0	10.0	5.0	102	254	127	1.6	22	1	M100695	
			4.0	10.3	4.0	102	262	102	1.5	20	1	M100695	
			4.0	10.3	4.0	102	262	102	1.7	23	1	M100464	Wrapped muffler
			5.0	10.0	5.0	127	254	127	1.1	15	1	M100582	OE replacement
			5.0	10.0	5.0	127	254	127	1.1	15	1	M101159	Silent Partner Stainless
			5.0	10.0	5.0	127	254	127	1.1	15	1	M101182	Silent Partner Aluminized
C-15	375 to 435	4.0	9.0	4.0	102	229	102	1.0	13	1	M090544		
		4.0	10.0	4.0	102	254	102	1.0	14	1	M100466		
		4.0	10.0	5.0	102	254	127	1.6	22	1	M100695		
		4.0	10.3	4.0	102	262	102	1.9	26	1	M100464	Wrapped muffler	
		5.0	10.0	5.0	127	254	127	1.3	17	1	M100582	OE replacement	
		5.0	10.0	5.0	127	254	127	1.3	17	1	M101159	Silent Partner Stainless	
C-15	455 to 500	4.0	9.0	4.0	102	229	102	1.3	18	1	M090544		
		4.0	10.0	4.0	102	254	102	1.4	19	1	M100466		
		4.0	10.0	5.0	102	254	127	2.2	30	1	M100695		
		5.0	10.0	5.0	127	254	127	1.7	23	1	M100582	OE replacement	
		5.0	10.0	5.0	127	254	127	1.7	23	1	M101159	Silent Partner Stainless	
C-16	575 to 600	4.0	9.0	4.0	102	229	102	1.7	23	1	M090544		
		4.0	10.0	4.0	102	254	102	1.8	24	1	M100466		
		4.0	10.0	5.0	102	254	127	2.8	38	1	M100695		
		5.0	10.0	5.0	127	254	127	2.2	29	1	M100582	OE replacement	
		5.0	10.0	5.0	127	254	127	2.2	29	1	M101159	Silent Partner Stainless	
3406E	355 to 435	4.0	9.0	4.0	102	229	102	2.2	29	1	M101182	Silent Partner Aluminized	
		4.0	9.0	4.0	102	229	102	1.4	19	1	M090544		
		4.0	10.0	4.0	102	254	102	1.4	20	1	M100466		
		4.0	10.0	5.0	102	254	127	2.3	31	1	M100695		
		5.0	10.0	5.0	127	254	127	1.8	24	1	M100582	OE replacement	
3406E	455 to 475	5.0	10.0	5.0	127	254	127	1.8	24	1	M101159	Silent Partner Stainless	
		5.0	10.0	5.0	127	254	127	1.8	24	1	M101182	Silent Partner Aluminized	
		4.0	9.0	4.0	102	229	102	1.5	20	1	M090544		
		4.0	10.0	4.0	102	254	102	1.6	21	1	M100466		
		4.0	10.0	5.0	102	254	127	2.5	34	1	M100695		
3406E	500 to 600	5.0	10.0	5.0	127	254	127	1.9	26	1	M100582	OE replacement	
		5.0	10.0	5.0	127	254	127	1.9	26	1	M101159	Silent Partner Stainless	
		5.0	10.0	5.0	127	254	127	1.9	26	1	M101182	Silent Partner Aluminized	
		4.0	9.0	4.0	102	229	102	1.7	23	1	M090544		
		4.0	10.0	4.0	102	254	102	1.8	24	1	M100466		
3116	170 to 185	4.0	10.0	5.0	102	254	127	2.8	38	1	M100695		
		5.0	10.0	5.0	127	254	127	2.2	29	1	M100582	OE replacement	
		5.0	10.0	5.0	127	254	127	2.2	29	1	M101159	Silent Partner Stainless	
		5.0	10.0	5.0	127	254	127	2.2	29	1	M101182	Silent Partner Aluminized	
3116	200 to 275	4.0	9.0	5.0	102	229	127	1.1	15	3	M090823		
		4.0	10.0	5.0	102	254	127	2.4	33	3	M100567		
		4.0	11.8	5.0	102	300	127	1.2	16	3	M120598		
		5.0	10.0	5.0	127	254	127	1.1	14	3	M100213		
3116	300	4.0	9.0	5.0	102	229	127	1.6	22	3	M090823		
		4.0	11.8	5.0	102	300	127	2.6	35	3	M120598		
		5.0	10.0	5.0	127	254	127	2.3	31	3	M100213		
3176	365	4.0	9.0	5.0	102	229	127	2.0	28	3	M090823		
		4.0	11.8	5.0	102	300	127	2.2	29	3	M120598		
		5.0	10.0	5.0	127	254	127	1.9	26	3	M100213		
3176	275 to 300	4.0	9.0	5.0	102	229	127	1.6	21	3	M090823		

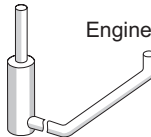

Engine Make & Exhaust System Configuration	Engine Model	H.P.	Muffler Dimensions						Backpressure		Muffler Style & Part No.	Notes				
			inches			mm			inches of Hg	H ₂ O						
			Inlet	Body	Outlet	Inlet	Body	Outlet								
			4.0	11.8	5.0	102	300	127	1.6	22	3	M120598				
			5.0	10.0	5.0	127	254	127	1.5	20	3	M100213				
3176	350		4.0	9.0	5.0	102	229	127	2.0	27	3	M090823				
			4.0	11.8	5.0	102	300	127	2.1	28	3	M120598				
			5.0	10.0	5.0	127	254	127	1.8	25	3	M100213				
			4.0	9.0	5.0	102	229	127	2.1	28	3	M090823				
3306	300		4.0	11.8	5.0	102	300	127	2.2	30	3	M120598				
			5.0	10.0	5.0	127	254	127	1.9	26	3	M100213				
			4.0	9.0	5.0	102	229	127	1.5	20	3	M090823				
3306B	245		4.0	11.8	5.0	102	300	127	1.5	21	3	M120598				
			5.0	10.0	5.0	127	254	127	1.4	18	3	M100213				
			4.0	9.0	5.0	102	229	127	2.0	27	3	M090823				
3306B	285 to 300		4.0	11.8	5.0	102	300	127	2.1	28	3	M120598				
			5.0	10.0	5.0	127	254	127	1.8	25	3	M100213				
			4.0	9.0	5.0	102	229	127	2.4	32	3	M090823				
3406B	Multi-Torque 300 to 310		4.0	11.8	5.0	102	300	127	2.5	34	3	M120598				
			5.0	10.0	5.0	127	254	127	2.2	30	3	M100213				
			4.0	9.0	5.0	102	229	127	2.8	38	3	M090823				
3406B	330		4.0	11.8	5.0	102	300	127	2.9	40	3	M120598				
			5.0	10.0	5.0	127	254	127	2.6	35	3	M100213				
			4.0	9.0	5.0	102	229	127	1.3	18	3	M090823				
3126B	175 to 230		4.0	11.8	5.0	102	300	127	1.4	19	3	M120598				
			5.0	10.0	5.0	127	254	127	1.2	17	3	M100213				
			4.0	9.0	5.0	102	229	127	1.6	22	3	M090823				
3126B	250		4.0	11.8	5.0	102	300	127	1.7	23	3	M120598				
			5.0	10.0	5.0	127	254	127	1.5	20	3	M100213				
			4.0	9.0	5.0	102	229	127	1.7	23	3	M090823				
3126B	275 to 300		4.0	11.8	5.0	102	300	127	1.8	25	3	M120598				
			5.0	10.0	5.0	127	254	127	1.6	22	3	M100213				
			4.0	9.0	5.0	102	229	127	2.1	29	3	M090823				
3126B	330		4.0	11.8	5.0	102	300	127	2.3	31	3	M120598				
			5.0	10.0	5.0	127	254	127	2.0	27	3	M100213				
			4.0	9.0	5.0	102	229	127	2.3	31	3	M090823				
C-10	305 to 370		4.0	11.8	5.0	102	300	127	2.4	32	3	M120598				
			5.0	10.0	5.0	127	254	127	2.1	29	3	M100213				
			4.0	9.0	5.0	102	229	127	2.5	33	3	M090823				
C-12	335 to 355		4.0	11.8	5.0	102	300	127	2.6	35	3	M120598				
			5.0	10.0	5.0	127	254	127	2.3	31	3	M100213				
			4.0	9.0	5.0	102	229	127	2.6	36	3	M090823				
C-12	380 to 430		4.0	11.8	5.0	102	300	127	2.8	38	3	M120598				
			5.0	10.0	5.0	127	254	127	2.5	34	3	M100213				
			4.0	9.0	5.0	102	229	127	3.0	40	3	M090823				
C-15	355		5.0	10.0	5.0	127	254	127	2.9	39	3	M100213				
			3.0	11.0	4.0	76	279	102	1.3	17	1	M111029	OE replacement			
3116	170-185		3.5	8x11.5	4.0	89	203x292	102	2.0	27	2	M090680	OE replacement			
			4.0	10.0	4.0	102	254	102	2.0	28	2	M100048	Aftermarket			
			4.0	11.0	4.0	102	279	102	2.0	27	2	M110012				
			4.0	11.0	4.0	102	279	102	1.8	24	2	M110189	OE replacement			
			4.0	11.0	5.0	102	279	127	1.1	15	2	M111028	Inlet dimension is OD			
			4.0	10x15	4.0	102	254x381	102	1.5	20	2	M120100	Aftermarket, shorter than OE			
			4.0	8.3x11.5	4.0	102	211x292	102	2.0	27	2	M090280	Aftermarket, shorter than OE			
			4.0	8.3x11.5	4.0	102	211x292	102	1.9	26	2	M090534	Aftermarket, shorter than OE			
			5.0	10x15	5.0	127	254x381	127	1.1	15	2	M120108	For off-hwy, shorter than OE			
			5.0	10x15	5.0	127	254x381	127	0.8	10	2	M120225	For off-hwy, shorter than OE			
			5.0	10x15	5.0	127	254x381	127	1.2	16	2	M120365	Aftermarket			
			5.0	10x15	5.0	127	254x381	127	1.2	17	2	M120448	OE replacement			
			3116	200-275		3.0	11.0	4.0	76	279	102	1.8	25	1	M111029	OE replacement
						3.5	8x11.5	4.0	89	203x292	102	2.9	39	2	M090680	OE replacement
						4.0	10.0	4.0	102	254	102	2.9	40	2	M100048	Aftermarket
						4.0	11.0	4.0	102	279	102	2.9	39	2	M110012	
4.0	11.0	4.0				102	279	102	2.6	35	2	M111028	Inlet dimension is OD			
4.0	11.0	4.0				102	279	102	2.6	35	2	M110189	OE replacement			
4.0	10x15	4.0				102	254x381	102	2.2	30	2	M120100	Aftermarket, shorter than OE			
4.0	8.3x11.5	4.0				102	211x292	102	2.9	39	2	M090280	Aftermarket, shorter than OE			
4.0	8.3x11.5	4.0				102	211x292	102	2.7	37	2	M090534	Aftermarket, shorter than OE			

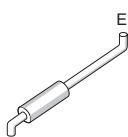

Truck Engine Muffler Application



TRUCK ENGINE APPL.

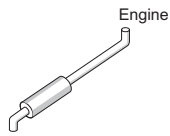

Engine Make & Exhaust System Configuration	Engine Model	Engine H.P.	Muffler Dimensions inches			Muffler Dimensions mm			Backpressure inches of Hg		Muffler Style & Part No.	Notes	
			Inlet	Body	Outlet	Inlet	Body	Outlet	Hg	H ₂ O			
3116	300		5.0	10x15	5.0	127	254x381	127	1.6	22	2	M120108	For off-hwy, shorter than OE
			5.0	10x15	5.0	127	254x381	127	1.1	15	2	M120225	For off-hwy, shorter than OE
			5.0	10x15	5.0	127	254x381	127	1.7	23	2	M120365	Aftermarket
			5.0	10x15	5.0	127	254x381	127	1.8	24	2	M120448	OE replacement
3176	275 to 300		3.0	11.0	4.0	76	279	102	2.7	37	1	M111029	OE replacement
			4.0	11.0	5.0	102	279	127	2.3	31	2	M111028	Inlet dimension is OD
			5.0	10x15	5.0	127	254x381	127	2.4	33	2	M120108	For off-hwy, shorter than OE
			5.0	10x15	5.0	127	254x381	127	1.6	22	2	M120225	For off-hwy, shorter than OE
			5.0	10x15	5.0	127	254x381	127	2.6	35	2	M120365	Aftermarket
			5.0	10x15	5.0	127	254x381	127	2.6	36	2	M120448	OE replacement
			4.0	10.0	4.0	102	254	102	2.7	37	2	M100048	Aftermarket
3176	350 to 365		4.0	11.0	4.0	102	279	102	2.6	36	2	M110012	Aftermarket
			4.0	11.0	4.0	102	279	102	2.4	32	2	M110189	OE replacement
			4.0	11.0	5.0	102	279	127	1.4	19	2	M111028	Inlet dimension is OD
			4.0	10x15	4.0	102	254x381	102	2.0	27	2	M120100	Aftermarket, shorter than OE
			4.0	8.3x11.5	4.0	102	211x292	102	2.7	36	2	M090280	Aftermarket, shorter than OE
			4.0	8.3x11.5	4.0	102	211x292	102	2.5	34	2	M090534	Aftermarket, shorter than OE
			5.0	10x15	5.0	127	254x381	127	1.5	20	2	M120108	For off-hwy, shorter than OE
			5.0	10x15	5.0	127	254x381	127	1.0	13	2	M120225	For off-hwy, shorter than OE
			5.0	10x15	5.0	127	254x381	127	1.5	21	2	M120365	Aftermarket
			5.0	10x15	5.0	127	254x381	127	1.6	22	2	M120448	OE replacement
			4.0	10x15	4.0	102	254x381	102	2.6	36	2	M120100	Aftermarket, shorter than OE
			4.0	11.0	5.0	102	279	127	1.8	25	2	M111028	Inlet dimension is OD
5.0	10x15	5.0	127	254x381	127	1.9	26	2	M120108	For off-hwy, shorter than OE			
5.0	10x15	5.0	127	254x381	127	1.3	17	2	M120225	For off-hwy, shorter than OE			
5.0	10x15	5.0	127	254x381	127	2.0	28	2	M120365	Aftermarket			
5.0	10x15	5.0	127	254x381	127	2.1	29	2	M120448	OE replacement			
5.0	10x15	6.0	152	254x381	152	1.1	14	2	M122300	For off-hwy, shorter than OE			
3306	300		3.0	11.0	4.0	76	279	102	2.2	30	1	M111029	OE replacement
			4.0	11.0	5.0	102	279	127	1.8	25	2	M111028	Inlet dimension is OD
			4.0	10x15	4.0	102	254x381	102	2.6	36	2	M120100	Aftermarket, shorter than OE
			5.0	10x15	5.0	127	254x381	127	1.9	26	2	M120108	For off-hwy, shorter than OE
			5.0	10x15	5.0	127	254x381	127	1.3	17	2	M120225	For off-hwy, shorter than OE
			5.0	10x15	5.0	127	254x381	127	2.1	28	2	M120365	Aftermarket
			5.0	10x15	5.0	127	254x381	127	2.1	29	2	M120448	OE replacement
3306B	245		4.0	10.0	4.0	102	254	102	2.5	35	2	M100048	Aftermarket
			4.0	11.0	4.0	102	279	102	2.5	34	2	M110012	Aftermarket
			4.0	11.0	4.0	102	279	102	2.2	30	2	M110189	OE replacement
			4.0	11.0	5.0	102	279	127	1.3	18	2	M111028	Inlet dimension is OD
			4.0	10x15	4.0	102	254x381	102	1.9	25	2	M120100	Aftermarket, shorter than OE
			4.0	8.3x11.5	4.0	102	211x292	102	2.5	34	2	M090280	Aftermarket, shorter than OE
			4.0	8.3x11.5	4.0	102	211x292	102	2.3	32	2	M090534	Aftermarket, shorter than OE
			5.0	10x15	5.0	127	254x381	127	1.4	19	2	M120108	For off-hwy, shorter than OE
			5.0	10x15	5.0	127	254x381	127	0.9	12	2	M120225	For off-hwy, shorter than OE
			5.0	10x15	5.0	127	254x381	127	1.4	20	2	M120365	Aftermarket
			5.0	10x15	5.0	127	254x381	127	1.5	20	2	M120448	OE replacement
3306B	285 to 300		4.0	11.0	5.0	102	279	127	1.8	24	2	M111028	Inlet dimension is OD
			4.0	10x15	4.0	102	254x381	102	2.5	34	2	M120100	Aftermarket, shorter than OE
			5.0	10x15	5.0	127	254x381	127	1.8	25	2	M120108	For off-hwy, shorter than OE
			5.0	10x15	5.0	127	254x381	127	1.2	16	2	M120225	For off-hwy, shorter than OE
			5.0	10x15	5.0	127	254x381	127	2.0	27	2	M120365	Aftermarket
5.0	10x15	5.0	127	254x381	127	2.0	28	2	M120448	OE replacement			
3406B	Multi-Torque 300-310		4.0	11.0	5.0	102	279	127	2.1	29	2	M111028	Inlet dimension is OD
			5.0	10x15	5.0	127	254x381	127	2.2	30	2	M120108	For off-hwy, shorter than OE
			5.0	10x15	5.0	127	254x381	127	1.5	20	2	M120225	For off-hwy, shorter than OE
			5.0	10x15	5.0	127	254x381	127	2.4	32	2	M120365	Aftermarket
			5.0	10x15	5.0	127	254x381	127	2.4	33	2	M120448	OE replacement
3406B	330		3.0	11.0	4.0	76	279	102	3.0	40	1	M111029	OE replacement
			4.0	11.0	5.0	102	279	127	2.5	34	2	M111028	Inlet dimension is OD
			5.0	10x15	5.0	127	254x381	127	2.6	36	2	M120108	For off-hwy, shorter than OE
			5.0	10x15	5.0	127	254x381	127	1.7	23	2	M120225	For off-hwy, shorter than OE
			5.0	10x15	5.0	127	254x381	127	2.8	38	2	M120365	Aftermarket
			5.0	10x15	5.0	127	254x381	127	2.9	39	2	M120448	OE replacement
3406B	350		4.0	11.0	5.0	102	279	127	2.7	37	2	M111028	Inlet dimension is OD
			5.0	10x15	5.0	127	254x381	127	1.9	26	2	M120225	For off-hwy, shorter than OE

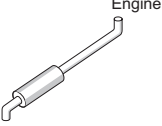
Engine Make & Exhaust System Configuration	Engine Model	H.P.	Muffler Dimensions						Backpressure		Muffler Style & Part No.	Notes	
			inches			mm			inches of Hg	H ₂ O			
			Inlet	Body	Outlet	Inlet	Body	Outlet					
	3406B	400 to 460	5.0	10x15	5.0	127	254x381	127	2.5	34	2	M120225	For off-hwy, shorter than OE
	3126B	175	3.0	11.0	4.0	76	279	102	1.2	17	1	M111029	OE replacement
			4.0	8.3x11.5	4.0	102	211x292	102	2.0	27	2	M090280	Aftermarket, shorter than OE
			4.0	8.3x11.5	4.0	102	211x292	102	1.9	26	2	M090534	Aftermarket, shorter than OE
			4.0	10.0	4.0	102	254	102	2.1	28	2	M100048	Aftermarket
			4.0	11.0	4.0	102	279	102	2.0	27	2	M110012	
			4.0	11.0	4.0	102	279	102	1.8	25	2	M110189	OE replacement
			4.0	11.0	5.0	102	279	127	1.0	14	2	M111028	Inlet dimension is OD
			4.0	10x15	4.0	102	254x381	102	1.5	20	2	M120100	Aftermarket, shorter than OE
			5.0	10x15	5.0	127	254x381	127	1.1	15	2	M120108	For off-hwy, shorter than OE
	5.0	10x15	5.0	127	254x381	127	1.2	16	2	M120365	Aftermarket		
	5.0	10x15	5.0	127	254x381	127	1.2	17	2	M120448	OE replacement		
	3126B	190	3.0	11.0	4.0	76	279	102	1.5	21	1	M111029	OE replacement
			4.0	10.0	4.0	102	254	102	2.5	34	2	M100048	Aftermarket
			4.0	11.0	4.0	102	279	102	2.4	33	2	M110012	
4.0			11.0	4.0	102	279	102	2.2	30	2	M110189	OE replacement	
4.0			10x15	4.0	102	254x381	102	1.8	25	2	M120100	Aftermarket, shorter than OE	
4.0			8.3x11.5	4.0	102	211x292	102	2.5	34	2	M090280	Aftermarket, shorter than OE	
4.0			8.3x11.5	4.0	102	211x292	102	2.3	31	2	M090534	Aftermarket, shorter than OE	
4.0			11.0	5.0	102	279	127	1.3	17	2	M111028	Inlet dimension is OD	
5.0			10x15	5.0	127	254x381	127	1.4	18	2	M120108	For off-hwy, shorter than OE	
5.0	10x15	5.0	127	254x381	127	1.4	19	2	M120365	Aftermarket			
5.0	10x15	5.0	127	254x381	127	1.5	20	2	M120448	OE replacement			
3126B	210 to 230	3.0	11.0	4.0	76	279	102	1.4	19	1	M111029	OE replacement	
		4.0	10.0	4.0	102	254	102	2.3	31	2	M100048	Aftermarket	
		4.0	11.0	4.0	102	279	102	2.2	30	2	M110012		
		4.0	11.0	4.0	102	279	102	2.0	27	2	M110189	OE replacement	
		4.0	11.0	5.0	102	279	127	1.2	16	2	M111028	Inlet dimension is OD	
		4.0	10x15	4.0	102	254x381	102	1.7	23	2	M120100	Aftermarket, shorter than OE	
		4.0	8.3x11.5	4.0	102	211x292	102	2.2	30	2	M090280	Aftermarket, shorter than OE	
		4.0	8.3x11.5	4.0	102	211x292	102	2.1	29	2	M090534	Aftermarket, shorter than OE	
		5.0	10x15	5.0	127	254x381	127	1.2	17	2	M120108	For off-hwy, shorter than OE	
		5.0	10x15	5.0	127	254x381	127	1.3	18	2	M120365	Aftermarket	
		5.0	10x15	5.0	127	254x381	127	1.3	18	2	M120448	OE replacement	
3126B	250	3.0	11.0	4.0	76	279	102	1.7	23	1	M111029	OE replacement	
		4.0	10.0	4.0	102	254	102	2.8	38	2	M100048	Aftermarket	
		4.0	11.0	4.0	102	279	102	2.7	37	2	M110012		
		4.0	11.0	4.0	102	279	102	2.4	33	2	M110189	OE replacement	
		4.0	11.0	5.0	102	279	127	1.4	19	2	M111028	Inlet dimension is OD	
		4.0	10x15	4.0	102	254x381	102	2.0	27	2	M120100	Aftermarket, shorter than OE	
		4.0	8.3x11.5	4.0	102	211x292	102	2.7	37	2	M090280	Aftermarket, shorter than OE	
		4.0	8.3x11.5	4.0	102	211x292	102	2.6	35	2	M090534	Aftermarket, shorter than OE	
		5.0	10x15	5.0	127	254x381	127	1.5	20	2	M120108	For off-hwy, shorter than OE	
		5.0	10x15	5.0	127	254x381	127	1.6	21	2	M120365	Aftermarket	
		5.0	10x15	5.0	127	254x381	127	1.6	22	2	M120448	OE replacement	
3126B	275 to 300	3.0	11.0	4.0	76	279	102	1.8	25	1	M111029	OE replacement	
		4.0	11.0	4.0	102	279	102	2.9	40	2	M110012		
		4.0	11.0	4.0	102	279	102	2.6	36	2	M110189	OE replacement	
		4.0	11.0	5.0	102	279	127	1.5	21	2	M111028	Inlet dimension is OD	
		4.0	10x15	4.0	102	254x381	102	2.2	30	2	M120100	Aftermarket, shorter than OE	
		4.0	8.3x11.5	4.0	102	211x292	102	3.0	40	2	M090280	Aftermarket, shorter than OE	
		4.0	8.3x11.5	4.0	102	211x292	102	2.8	38	2	M090534	Aftermarket, shorter than OE	
		5.0	10x15	5.0	127	254x381	127	1.6	22	2	M120108	For off-hwy, shorter than OE	
		5.0	10x15	5.0	127	254x381	127	1.7	23	2	M120365	Aftermarket	
		5.0	10x15	5.0	127	254x381	127	1.8	24	2	M120448	OE replacement	
		3126B	330	3.0	11.0	4.0	76	279	102	2.3	31	1	M111029
4.0	10x15			4.0	102	254x381	102	2.7	37	2	M120100	Aftermarket, shorter than OE	
4.0	11.0			5.0	102	279	127	1.9	26	2	M111028	Inlet dimension is OD	
5.0	10x15			5.0	127	254x381	127	2.0	27	2	M120108	For off-hwy, shorter than OE	
5.0	10x15			5.0	127	254x381	127	2.1	29	2	M120365	Aftermarket	
5.0	10x15	5.0	127	254x381	127	2.2	30	2	M120448	OE replacement			
C-10	305 to 370	3.0	11.0	4.0	76	279	102	2.4	32	1	M111029	OE replacement	
		4.0	11.0	5.0	102	279	127	2.0	27	2	M111028	Inlet dimension is OD	
		4.0	10x15	4.0	102	254x381	102	2.9	39	2	M120100	Aftermarket, shorter than OE	
		5.0	10x15	5.0	127	254x381	127	2.1	29	2	M120108	For off-hwy, shorter than OE	
5.0	10x15	5.0	127	254x381	127	2.2	30	2	M120365	Aftermarket			

TRUCK ENGINE APPL.

Truck Engine Muffler Application

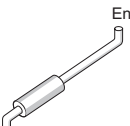
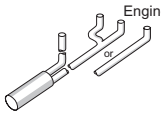

TRUCK ENGINE APPL.

Engine Make & Exhaust System Configuration	Engine Model	Engine H.P.	Muffler Dimensions inches			Muffler Dimensions mm			Backpressure inches of Hg		Muffler Style & Part No.	Notes			
			Inlet	Body	Outlet	Inlet	Body	Outlet	Hg	H ₂ O					
	C-12	335	5.0	10x15	5.0	127	254x381	127	2.3	32	2	M120448	OE replacement		
			3.0	11.0	4.0	76	279	102	2.5	35	1	M111029	OE replacement		
			3.0	11.0	4.0	76	279	102	2.6	35	1	M111029	OE replacement		
			4.0	11.0	5.0	102	279	127	2.1	29	2	M111028	Inlet dimension is OD		
			4.0	11.0	5.0	102	279	127	2.2	30	2	M111028	Inlet dimension is OD		
			5.0	10x15	5.0	127	254x381	127	2.3	31	2	M120108	For off-hwy, shorter than OE		
			5.0	10x15	5.0	127	254x381	127	2.4	32	2	M120365	Aftermarket		
			5.0	10x15	5.0	127	254x381	127	2.5	34	2	M120448	OE replacement		
			5.0	10x15	5.0	127	254x381	127	2.3	31	2	M120108	For off-hwy, shorter than OE		
			5.0	10x15	5.0	127	254x381	127	2.4	33	2	M120365	Aftermarket		
			5.0	10x15	5.0	127	254x381	127	2.5	34	2	M120448	OE replacement		
			C-12	380 to 430	3.0	11.0	4.0	76	279	102	2.8	38	1	M111029	OE replacement
					4.0	11.0	5.0	102	279	127	2.4	32	2	M111028	Inlet dimension is OD
					4.0	11.0	5.0	102	279	127	2.8	38	2	M111028	Inlet dimension is OD
5.0	10x15	5.0			127	254x381	127	2.5	34	2	M120108	For off-hwy, shorter than OE			
5.0	10x15	5.0			127	254x381	127	2.6	36	2	M120365	Aftermarket			
C-15	355	5.0	10x15	5.0	127	254x381	127	2.7	37	2	M120448	OE replacement			
		5.0	10x15	5.0	127	254x381	127	2.9	40	2	M120108	For off-hwy, shorter than OE			
		5.0	10x15	5.0	127	254x381	127	1.9	26	2	M120225	For off-hwy, shorter than OE			
		6.0	10x15	6.0	152	254x381	152	1.6	22	2	M122300	For off-hwy, shorter than OE			
C-15	375	5.0	10x15	5.0	127	254x381	127	2.4	33	2	M120225	For off-hwy, shorter than OE			
		6.0	10x15	6.0	152	254x381	152	2.0	27	2	M122300	For off-hwy, shorter than OE			
C-15	435 to 500	6.0	10x15	6.0	152	254x381	152	2.5	34	2	M122300	For off-hwy, shorter than OE			
C-16	575 to 600	6.0	10x15	6.0	152	254x381	152	2.7	37	2	M122300	For off-hwy, shorter than OE			
3406E	355	4.0	11.0	5.0	102	279	127	2.8	38	2	M111028	Inlet dimension is OD			
		5.0	10x15	5.0	127	254x381	127	2.9	40	2	M120108	For off-hwy, shorter than OE			
		5.0	10x15	5.0	127	254x381	127	1.9	26	2	M120225	For off-hwy, shorter than OE			
		6.0	10x15	6.0	152	254x381	152	1.6	22	2	M122300	For off-hwy, shorter than OE			
3406E	375	5.0	10x15	5.0	127	254x381	127	2.4	33	2	M120225	For off-hwy, shorter than OE			
		6.0	10x15	6.0	152	254x381	152	2.0	27	2	M122300	For off-hwy, shorter than OE			
3406E	435 to 455	5.0	10x15	5.0	127	254x381	127	2.8	37	2	M120225	For off-hwy, shorter than OE			
		6.0	10x15	6.0	152	254x381	152	2.3	31	2	M122300	For off-hwy, shorter than OE			
3406E	475 to 500	6.0	10x15	6.0	152	254x381	152	2.5	34	2	M122300	For off-hwy, shorter than OE			
3406E	575 to 600	6.0	10x15	6.0	152	254x381	152	2.7	37	2	M122300	For off-hwy, shorter than OE			
	3406B	350	5.0	10x15	5.0	127	254x381	127	1.9	26	5	M120131	For off-hwy, shorter than OE		
			5.0	10x15	5.0	127	254x381	127	2.2	30	5	M120450	OE replacement		
3406B	400 to 460	5.0	10x15	5.0	127	254x381	127	2.5	33	5	M120131	For off-hwy, shorter than OE			
		5.0	10x15	5.0	127	254x381	127	2.9	39	5	M120450	OE replacement			
C-12	335	5.0	10x15	5.0	127	254x381	127	1.5	20	5	M120131	For off-hwy, shorter than OE			
		5.0	10x15	5.0	127	254x381	127	2.9	40	5	M120176	Aftermarket, shorter than OE			
		5.0	10x15	5.0	127	254x381	127	2.9	40	5	M120189	Aftermarket, shorter than OE			
		5.0	10x15	5.0	127	254x381	127	1.7	24	5	M120450	OE replacement			
C-12	355 to 430	5.0	10x15	5.0	127	254x381	127	1.7	23	5	M120131	For off-hwy, shorter than OE			
		5.0	10x15	5.0	127	254x381	127	2.0	27	5	M120450	OE replacement			
C-15	355	5.0	10x15	5.0	127	254x381	127	1.9	26	5	M120131	For off-hwy, shorter than OE			
		5.0	10x15	5.0	127	254x381	127	2.2	31	5	M120450	OE replacement			
C-15	375	5.0	10x15	5.0	127	254x381	127	2.4	33	5	M120131	For off-hwy, shorter than OE			
		5.0	10x15	5.0	127	254x381	127	2.8	38	5	M120450	OE replacement			
3406E	355	5.0	10x15	5.0	127	254x381	127	1.9	26	5	M120131	For off-hwy, shorter than OE			
		5.0	10x15	5.0	127	254x381	127	2.3	31	5	M120450	OE replacement			
3406E	375	5.0	10x15	5.0	127	254x381	127	2.4	33	5	M120131	For off-hwy, shorter than OE			
		5.0	10x15	5.0	127	254x381	127	2.8	38	5	M120450	OE replacement			
3406E	435	5.0	10x15	5.0	127	254x381	127	2.7	37	5	M120131	For off-hwy, shorter than OE			
3406E	455	5.0	10x15	5.0	127	254x381	127	2.8	37	5	M120131	For off-hwy, shorter than OE			

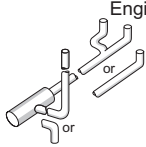









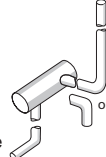













Engine Make & Exhaust System Configuration	Engine Model	Engine H.P.	Muffler Dimensions						Backpressure		Muffler Style & Part No.	Notes				
			inches			mm			inches of Hg	H ₂ O						
			Inlet	Body	Outlet	Inlet	Body	Outlet								
	3116	170-185	3.5	8.3x11.5	4.0	89	211x292	102	2.6	35	4	M090547	OE replacement			
			3.5	8.3x11.5	4.0	89	211x292	102	1.6	21	4	M090548	OE replacement			
			4.0	10.0	4.0	102	254	102	2.0	28	4	M100052				
			4.0	10.0	5.0	102	254	127	1.9	26	4	M100635				
			4.0	11.0	4.0	102	279	102	1.7	23	4	M110112				
			4.0	11.0	4.0	102	279	102	1.7	23	4	M110148				
			4.0	11.0	4.0	102	279	102	1.7	23	4	M110311	Inlet dimension is OD			
			4.0	10x15	4.0	102	254x381	102	2.0	27	4	M120367	Aftermarket, shorter than OE			
			5.0	11.0	5.0	127	279	127	1.0	13	4	M110014	OE replacement			
			5.0	10x15	5.0	127	254x381	127	1.0	14	4	M120366	OE replacement			
			5.0	10x15	5.0	127	254x381	127	1.6	22	4	M120417	Aftermarket, shorter than OE			
				3116	220-275	3.5	8.3x11.5	4.0	89	211x292	102	2.3	31	4	M090548	OE replacement
						4.0	10.0	4.0	102	254	102	2.9	40	4	M100052	
4.0	10.0	5.0				102	254	127	2.7	37	4	M100635				
4.0	11.0	4.0				102	279	102	2.4	33	4	M110112				
4.0	11.0	4.0				102	279	102	2.4	33	4	M110148				
4.0	11.0	4.0				102	279	102	2.4	33	4	M110311	Inlet dimension is OD			
4.0	10x15	4.0				102	254x381	102	2.9	39	4	M120367	Aftermarket, shorter than OE			
5.0	11.0	5.0				127	279	127	1.4	19	4	M110014	OE replacement			
5.0	10x15	5.0				127	254x381	127	1.5	20	4	M120366	OE replacement			
5.0	10x15	5.0				127	254x381	127	2.3	32	4	M120417	Aftermarket, shorter than OE			
	3116	300				5.0	11.0	5.0	127	279	127	2.1	28	4	M110014	OE replacement
						5.0	10x15	5.0	127	254x381	127	2.2	30	4	M120366	OE replacement
	3176	275 to 300				4.0	10.0	4.0	102	254	102	2.8	38	4	M100052	
			5.0	11.0	5.0	127	279	127	1.3	18	4	M110014	OE replacement			
			4.0	11.0	4.0	102	279	102	2.3	31	4	M110112				
			4.0	11.0	4.0	102	279	102	2.3	31	4	M110148				
			4.0	11.0	4.0	102	279	102	2.3	31	4	M110311	Inlet dimension is OD			
			4.0	11.0	4.0	102	279	102	2.0	28	4	M111025	Inlet & outlet dimension is OD			
			5.0	10x15	5.0	127	254x381	127	1.4	19	4	M120366	OE replacement			
			4.0	10x15	4.0	102	254x381	102	2.7	37	4	M120367	Aftermarket, shorter than OE			
			5.0	10x15	5.0	127	254x381	127	2.2	30	4	M120417	Aftermarket, shorter than OE			
	3176	350 to 365	5.0	11.0	5.0	127	279	127	1.7	24	4	M110014	OE replacement			
			4.0	11.0	4.0	102	279	102	2.7	36	4	M111025	Inlet & outlet dimension is OD			
			5.0	10x15	5.0	127	254x381	127	1.8	25	4	M120366	OE replacement			
			5.0	10x15	5.0	127	254x381	127	2.9	40	4	M120417	Aftermarket, shorter than OE			
	3306	300	5.0	11.0	5.0	127	279	127	1.8	24	4	M110014	OE replacement			
			4.0	11.0	4.0	102	279	102	2.7	37	4	M111025	Inlet & outlet dimension is OD			
			5.0	10x15	5.0	127	254x381	127	1.8	25	4	M120366	OE replacement			
			5.0	10x15	5.0	127	254x381	127	3.0	40	4	M120417	Aftermarket, shorter than OE			
	3306B	245	4.0	10.0	4.0	102	254	102	2.6	36	4	M100052				
			5.0	11.0	5.0	127	279	127	1.2	17	4	M110014	OE replacement			
			4.0	11.0	4.0	102	279	102	2.2	29	4	M110112				
			4.0	11.0	4.0	102	279	102	2.2	29	4	M110148				
			4.0	11.0	4.0	102	279	102	2.2	29	4	M110311	Inlet dimension is OD			
			4.0	11.0	4.0	102	279	102	1.9	26	4	M111025	Inlet & outlet dimension is OD			
			5.0	10x15	5.0	127	254x381	127	1.3	18	4	M120366	OE replacement			
			4.0	10x15	4.0	102	254x381	102	2.5	35	4	M120367	Aftermarket, shorter than OE			
			5.0	10x15	5.0	127	254x381	127	2.1	28	4	M120417	Aftermarket, shorter than OE			
				3306B	285	5.0	11.0	5.0	127	279	127	1.5	21	4	M110014	OE replacement
4.0	11.0	4.0				102	279	102	2.6	36	4	M110112				
4.0	11.0	4.0				102	279	102	2.6	36	4	M110148				
4.0	11.0	4.0				102	279	102	2.3	32	4	M111025	Inlet & outlet dimension is OD			
5.0	10x15	5.0				127	254x381	127	1.6	22	4	M120366	OE replacement			
5.0	10x15	5.0				127	254x381	127	2.6	35	4	M120417	Aftermarket, shorter than OE			
	3306B	300	5.0	11.0	5.0	127	279	127	1.7	23	4	M110014	OE replacement			
			4.0	11.0	4.0	102	279	102	2.6	35	4	M111025	Inlet & outlet dimension is OD			
			5.0	10x15	5.0	127	254x381	127	1.8	24	4	M120366	OE replacement			
			5.0	10x15	5.0	127	254x381	127	2.8	38	4	M120417	Aftermarket, shorter than OE			
	3406B	Multi-Torque 300-310	5.0	11.0	5.0	127	279	127	2.0	27	4	M110014	OE replacement			
			5.0	10x15	5.0	127	254x381	127	2.1	29	4	M120366	OE replacement			
	3406B	330	5.0	11.0	5.0	127	279	127	2.4	32	4	M110014	OE replacement			
			5.0	10x15	5.0	127	254x381	127	2.5	34	4	M120366	OE replacement			

Truck Engine Muffler Application



TRUCK ENGINE APPL.

Engine Make & Exhaust System Configuration	Engine Model	Engine H.P.	Muffler Dimensions inches			Muffler Dimensions mm			Backpressure inches of Hg		Muffler Style & Part No.	Notes	
			Inlet	Body	Outlet	Inlet	Body	Outlet	Hg	H ₂ O			
	3126B	175	4.0	10.0	4.0	102	254	102	2.1	29	4	M100052	
			5.0	11.0	5.0	127	279	127	1.0	14	4	M110014	OE replacement
			4.0	11.0	4.0	102	279	102	1.8	24	4	M110112	
			4.0	11.0	4.0	102	279	102	1.8	24	4	M110148	
			4.0	11.0	4.0	102	279	102	1.8	24	4	M110311	Inlet dimension is OD
			4.0	11.0	4.0	102	279	102	1.5	21	4	M111025	Inlet & outlet dimension is OD
			5.0	10x15	5.0	127	254x381	127	1.1	14	4	M120366	OE replacement
			4.0	10x15	4.0	102	254x381	102	2.1	28	4	M120367	Aftermarket, shorter than OE
			5.0	10x15	5.0	127	254x381	127	1.7	23	4	M120417	Aftermarket, shorter than OE
				3126B	190	4.0	10.0	4.0	102	254	102	2.6	35
5.0	11.0	5.0				127	279	127	1.2	17	4	M110014	OE replacement
4.0	11.0	4.0				102	279	102	2.1	29	4	M110112	
4.0	11.0	4.0				102	279	102	2.1	29	4	M110148	
4.0	11.0	4.0				102	279	102	2.1	29	4	M110311	Inlet dimension is OD
4.0	11.0	4.0				102	279	102	1.9	26	4	M111025	Inlet & outlet dimension is OD
5.0	10x15	5.0				127	254x381	127	1.3	18	4	M120366	OE replacement
4.0	10x15	4.0				102	254x381	102	2.5	34	4	M120367	Aftermarket, shorter than OE
5.0	10x15	5.0				127	254x381	127	2.1	28	4	M120417	Aftermarket, shorter than OE
	3126B	210 to 230				4.0	10.0	4.0	102	254	102	2.4	32
			5.0	11.0	5.0	127	279	127	1.1	15	4	M110014	OE replacement
			4.0	11.0	4.0	102	279	102	1.9	26	4	M110112	
			4.0	11.0	4.0	102	279	102	1.9	26	4	M110148	
			4.0	11.0	4.0	102	279	102	1.9	26	4	M110311	Inlet dimension is OD
			4.0	11.0	4.0	102	279	102	1.7	23	4	M111025	Inlet & outlet dimension is OD
			5.0	10x15	5.0	127	254x381	127	1.2	16	4	M120366	OE replacement
			4.0	10x15	4.0	102	254x381	102	2.3	31	4	M120367	Aftermarket, shorter than OE
			5.0	10x15	5.0	127	254x381	127	1.9	25	4	M120417	Aftermarket, shorter than OE
				3126B	250	4.0	10.0	4.0	102	254	102	2.9	39
5.0	11.0	5.0				127	279	127	1.4	18	4	M110014	OE replacement
4.0	11.0	4.0				102	279	102	2.4	32	4	M110112	
4.0	11.0	4.0				102	279	102	2.4	32	4	M110148	
4.0	11.0	4.0				102	279	102	2.4	32	4	M110311	Inlet dimension is OD
4.0	11.0	4.0				102	279	102	2.1	28	4	M111025	Inlet & outlet dimension is OD
5.0	10x15	5.0				127	254x381	127	1.4	19	4	M120366	OE replacement
4.0	10x15	4.0				102	254x381	102	2.8	38	4	M120367	Aftermarket, shorter than OE
5.0	10x15	5.0				127	254x381	127	2.3	31	4	M120417	Aftermarket, shorter than OE
	3126B	275				4.0	10.0	4.0	102	254	102	2.8	39
			5.0	11.0	5.0	127	279	127	1.3	18	4	M110014	OE replacement
			4.0	11.0	4.0	102	279	102	2.3	32	4	M110112	
			4.0	11.0	4.0	102	279	102	2.3	32	4	M110148	
			4.0	11.0	4.0	102	279	102	2.3	32	4	M110311	Inlet dimension is OD
			4.0	11.0	4.0	102	279	102	2.1	28	4	M111025	Inlet & outlet dimension is OD
			5.0	10x15	5.0	127	254x381	127	1.4	19	4	M120366	OE replacement
			4.0	10x15	4.0	102	254x381	102	2.7	37	4	M120367	Aftermarket, shorter than OE
			5.0	10x15	5.0	127	254x381	127	2.3	31	4	M120417	Aftermarket, shorter than OE
				3126B	300	5.0	11.0	5.0	127	279	127	1.5	20
4.0	11.0	4.0				102	279	102	2.6	35	4	M110112	
4.0	11.0	4.0				102	279	102	2.6	35	4	M110148	
4.0	11.0	4.0				102	279	102	2.6	35	4	M110311	Inlet dimension is OD
4.0	11.0	4.0				102	279	102	2.3	31	4	M111025	Inlet & outlet dimension is OD
5.0	10x15	5.0				127	254x381	127	1.5	21	4	M120366	OE replacement
	3126B	330	5.0	10x15	5.0	127	254x381	127	2.5	34	4	M120417	Aftermarket, shorter than OE
			5.0	11.0	5.0	127	279	127	1.8	25	4	M110014	OE replacement
			4.0	11.0	4.0	102	279	102	2.8	38	4	M111025	Inlet & outlet dimension is OD
	C-10	305 to 370	5.0	10x15	5.0	127	254x381	127	1.9	26	4	M120366	OE replacement
			4.0	11.0	4.0	102	279	102	3.0	40	4	M111025	Inlet & outlet dimension is OD
			5.0	10x15	5.0	127	254x381	127	2.0	28	4	M120366	OE replacement
	3316	170-185	4.0	10.0	4.0	102	254	102	2.1	28	6	M100572	
			4.0	10.0	4.0	102	254	102	2.1	28	6	M100865	
			4.0	11.0	4.0	102	279	102	1.6	22	6	M111026	Outlet dimension is O.D.
			5.0	10x15	5.0	127	254x381	127	1.1	14	6	M120418	For off-hwy, shorter than OE
	3316	220-275	4.0	11.0	4.0	102	279	102	2.3	32	6	M111026	Outlet dimension is OD
			5.0	10x15	5.0	127	254x381	127	1.5	21	6	M120418	For off-hwy, shorter than OE
	3316	300	5.0	10x15	5.0	127	254x381	127	2.3	31	6	M120418	For off-hwy, shorter than OE
	3176	365	4.0	11.0	4.0	102	279	102	2.9	40	6	M111026	Outlet dimension is OD
			5.0	10x15	5.0	127	254x381	127	1.9	26	6	M120418	For off-hwy, shorter than OE

Engine Make & Exhaust System Configuration	Engine Model	H.P.	Muffler Dimensions						Backpressure		Muffler Style & Part No.	Notes	
			inches			mm			inches of Hg	H ₂ O			
			Inlet	Body	Outlet	Inlet	Body	Outlet					
	3176	275 to 300	4.0	10.0	4.0	102	254	102	2.9	39	6	M100572	
			4.0	11.0	4.0	102	279	102	2.2	30	6	M111026	Outlet dimension is OD
			5.0	10x15	5.0	127	254x381	127	1.4	20	6	M120418	For off-hwy, shorter than OE
	3176	350	5.0	10x15	5.0	127	254x381	127	1.8	25	6	M120418	For off-hwy, shorter than OE
			4.0	11.0	4.0	102	279	102	2.8	38	6	M111026	Outlet dimension is OD
	3306	300	5.0	10x15	5.0	127	254x381	127	1.9	26	6	M120418	For off-hwy, shorter than OE
			4.0	11.0	4.0	102	279	102	3.0	40	6	M111026	Outlet dimension is OD
	3306B	245	4.0	10.0	4.0	102	254	102	2.7	37	6	M100572	
			4.0	11.0	4.0	102	279	102	2.1	28	6	M111026	Outlet dimension is OD
			5.0	10x15	5.0	127	254x381	127	1.4	18	6	M120418	For off-hwy, shorter than OE
	3306B	285 to 300	4.0	11.0	4.0	102	279	102	2.8	38	6	M111026	Outlet dimension is OD
			5.0	10x15	5.0	127	254x381	127	1.8	25	6	M120418	For off-hwy, shorter than OE
	3406B	Multi-Torque 300-310	5.0	10x15	5.0	127	254x381	127	2.2	30	6	M120418	For off-hwy, shorter than OE
	3406B	330	5.0	10x15	5.0	127	254x381	127	2.6	35	6	M120418	For off-hwy, shorter than OE
	3126B	175	4.0	10.0	4.0	102	254	102	2.2	30	6	M100572	
			4.0	11.0	4.0	102	279	102	1.7	23	6	M111026	Outlet dimension is OD
			5.0	10x15	5.0	127	254x381	127	1.1	15	6	M120418	For off-hwy, shorter than OE
	3126B	190	4.0	10.0	4.0	102	254	102	2.7	36	6	M100572	
			4.0	11.0	4.0	102	279	102	2.1	28	6	M111026	Outlet dimension is OD
			5.0	10x15	5.0	127	254x381	127	1.3	18	6	M120418	For off-hwy, shorter than OE
	3126B	210 to 230	4.0	10.0	4.0	102	254	102	2.4	33	6	M100572	
			4.0	11.0	4.0	102	279	102	1.9	25	6	M111026	Outlet dimension is OD
			5.0	10x15	5.0	127	254x381	127	1.2	16	6	M120418	For off-hwy, shorter than OE
	3126B	250	4.0	10.0	4.0	102	254	102	2.9	40	6	M100572	
			4.0	11.0	4.0	102	279	102	1.9	25	6	M111026	Outlet dimension is OD
			5.0	10x15	5.0	127	254x381	127	1.2	16	6	M120418	For off-hwy, shorter than OE
	3126B	275	4.0	10.0	4.0	102	254	102	2.9	40	6	M100572	
			4.0	11.0	4.0	102	279	102	1.9	25	6	M111026	Outlet dimension is OD
			5.0	10x15	5.0	127	254x381	127	1.2	16	6	M120418	For off-hwy, shorter than OE
	3126B	300	4.0	11.0	4.0	102	279	102	2.5	33	6	M111026	Outlet dimension is OD
			5.0	10x15	5.0	127	254x381	127	1.6	22	6	M120418	For off-hwy, shorter than OE
	3126B	330	5.0	10x15	5.0	127	254x381	127	2.0	27	6	M120418	For off-hwy, shorter than OE
	C-10	305 to 335	4.0	11.0	4.0	102	279	102	2.9	39	6	M111026	Outlet dimension is OD
			5.0	10x15	5.0	127	254x381	127	1.9	25	6	M120418	For off-hwy, shorter than OE
	C-10	350 to 370	5.0	10x15	5.0	127	254x381	127	2.1	28	6	M120418	For off-hwy, shorter than OE
	3116	170-185	4.0	11.0	4.0	102	279	102	2.2	30	3	M110479	
			4.0	11.0	4.0	102	279	102	2.0	28	3	M110674	
			4.0	11.0		102	279	0	2.0	27	3	M111024	Outlet has down spout
			4.0	10x15	5.0	102	254x381	127	1.2	16	3	M120566	OE replacement
			5.0	10x15	5.0	127	254x381	127	1.3	18	3	M120235	OE replacement
	3116	200-275	4.0	11.0	4.0	102	279	102	2.9	40	3	M110674	
			4.0	11.0		102	279	0	2.9	39	3	M111024	Outlet has down spout
			4.0	10x15	5.0	102	254x381	127	1.7	23	3	M120566	OE replacement
			5.0	10x15	5.0	127	254x381	127	1.9	26	3	M120235	OE replacement
	3116	300	4.0	10x15	5.0	102	254x381	127	2.6	35	3	M120566	OE replacement
	3176	275	4.0	11.0	4.0	102	279	102	2.6	36	3	M110479	
			4.0	11.0	4.0	102	279	102	2.4	33	3	M110674	Band clamp on inlet
			4.0	11.0		102	279		2.4	32	3	M111024	Outlet has down spout
			5.0	10x15	5.0	127	254x381	127	1.6	21	3	M120235	OE replacement
	3176	300	4.0	11.0	4.0	102	279	102	2.8	38	3	M110674	Band clamp on inlet
			4.0	11.0		102	279		2.7	37	3	M111024	Outlet has down spout
			5.0	10x15	5.0	127	254x381	127	1.8	25	3	M120235	OE replacement
	3176	350 to 365	5.0	10x15	5.0	127	254x381	127	2.4	32	3	M120235	OE replacement
	3306	300	5.0	10x15	5.0	127	254x381	127	2.4	33	3	M120235	OE replacement
	3306B	245	4.0	11.0	4.0	102	279	102	2.9	39	3	M110479	
			4.0	11.0	4.0	102	279	102	2.6	36	3	M110674	Band clamp on inlet
			4.0	11.0		102	279		2.6	35	3	M111024	Outlet has down spout
			5.0	10x15	5.0	127	254x381	127	1.7	23	3	M120235	OE replacement
	3306B	285 to 300	5.0	10x15	5.0	127	254x381	127	2.3	31	3	M120235	OE replacement

TRUCK ENGINE APPL.

Truck Engine Muffler Application

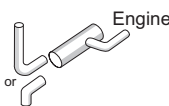

TRUCK ENGINE APPL.

Engine Make & Exhaust System Configuration	Engine Model	Engine H.P.	Muffler Dimensions						Backpressure		Muffler Style & Part No.	Notes	
			inches			mm			inches of Hg	H ₂ O			
 Engine	3126B	175	4.0	11.0	4.0	102	279	102	2.3	31	3	M110479	
			4.0	11.0	4.0	102	279	102	2.1	29	3	M110674	Band clamp on inlet
			4.0	11.0		102	279		2.1	28	3	M111024	Outlet has down spout
			5.0	10x15	5.0	127	254x381	127	1.4	19	3	M120235	OE replacement
3126B	190	4.0	11.0	4.0	102	279	102	2.8	38	3	M110479		
		4.0	11.0	4.0	102	279	102	2.6	35	3	M110674	Band clamp on inlet	
		4.0	11.0		102	279		2.5	34	3	M111024	Outlet has down spout	
		5.0	10x15	5.0	127	254x381	127	1.7	23	3	M120235	OE replacement	
3126B	210 to 230	4.0	11.0	4.0	102	279	102	2.6	35	3	M110479		
		4.0	11.0	4.0	102	279	102	2.4	32	3	M110674	Band clamp on inlet	
		4.0	11.0		102	279		2.3	31	3	M111024	Outlet has down spout	
		5.0	10x15	5.0	127	254x381	127	1.5	21	3	M120235	OE replacement	
3126B	250	4.0	11.0	4.0	102	279	102	2.9	39	3	M110674	Band clamp on inlet	
		4.0	11.0		102	279		2.8	38	3	M111024	Outlet has down spout	
		5.0	10x15	5.0	127	254x381	127	1.8	25	3	M120235	OE replacement	
3126B	275	4.0	11.0	4.0	102	279	102	2.8	39	3	M110674	Band clamp on inlet	
		4.0	11.0		102	279		2.7	37	3	M111024	Outlet has down spout	
		5.0	10x15	5.0	127	254x381	127	1.8	25	3	M120235	OE replacement	
3126B	300	5.0	10x15	5.0	127	254x381	127	2.0	27	3	M120235	OE replacement	
3126B	330	5.0	10x15	5.0	127	254x381	127	2.5	34	3	M120235	OE replacement	
C-10	305 to 370	5.0	10x15	5.0	127	254x381	127	2.6	36	3	M120235	OE replacement	

Cummins

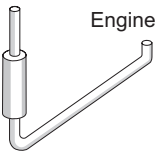

ISM	310 to 350	4.0	8.5	4.0	102	216	102	1.2	17	1	M085171			
		4.0	9.0	5.0	102	229	127	1.7	24	1	M090781			
		5.0	9.0	5.0	127	229	127	1.5	20	1	M090074			
		5.0	9.0	5.0	127	229	127	0.8	11	1	M090535	Low backpressure, off-hwy		
		5.0	10.0	5.0	127	254	127	0.8	11	1	M100463	Low backpressure, off-hwy		
		5.0	10.0	5.0	127	254	127	1.6	21	1	M100465	Best value, most popular		
		5.0	10.0	5.0	127	254	127	1.6	22	1	M100580	OE replacement		
		5.0	10.0	5.0	127	254	127	1.8	24	1	M100807	60" (1524mm) Long Body		
		5.0	10.0	5.0	127	254	127	1.3	18	1	M100944	OE replacement for higher HP		
		5.0	10.0	5.0	127	254	127	1.6	22	1	M101158	Silent Partner Stainless		
		5.0	10.0	5.0	127	254	127	1.6	22	1	M101181	Silent Partner Aluminized		
		5.0	10.0	5.0	127	254	127	1.6	22	1	M101263	Freightliner only		
		5.0	11.0	5.0	127	279	127	1.3	18	1	M110849			
		ISM	370 to 450	4.0	8.5	4.0	102	216	102	1.5	21	1	M085171	
				4.0	9.0	5.0	102	229	127	2.2	29	1	M090781	
				5.0	9.0	5.0	127	229	127	1.8	25	1	M090074	
5.0	9.0			5.0	127	229	127	1.0	13	1	M090535	Low backpressure, off-hwy		
5.0	10.0			5.0	127	254	127	1.0	13	1	M100463	Low backpressure, off-hwy		
5.0	10.0			5.0	127	254	127	1.9	26	1	M100465	Best value, most popular		
5.0	10.0			5.0	127	254	127	2.1	28	1	M100580	OE replacement		
5.0	10.0			5.0	127	254	127	2.2	30	1	M100807	60" (1524mm) Long Body		
5.0	10.0			5.0	127	254	127	1.6	22	1	M100944	OE replacement for higher HP		
5.0	10.0			5.0	127	254	127	2.0	27	1	M101158	Silent Partner Stainless		
5.0	10.0			5.0	127	254	127	2.0	27	1	M101181	Silent Partner Aluminized		
5.0	10.0			5.0	127	254	127	2.1	28	1	M101263	Freightliner only		
5.0	11.0			5.0	127	279	127	1.6	22	1	M110849			
ISM	500			4.0	8.5	4.0	102	216	102	1.7	24	1	M085171	
				4.0	9.0	5.0	102	229	127	2.5	34	1	M090781	
				5.0	9.0	5.0	127	229	127	2.1	29	1	M090074	
		5.0	9.0	5.0	127	229	127	1.1	15	1	M090535	Low backpressure, off-hwy		
		5.0	10.0	5.0	127	254	127	1.1	15	1	M100463	Low backpressure, off-hwy		
		5.0	10.0	5.0	127	254	127	2.2	30	1	M100465	Best value, most popular		
		5.0	10.0	5.0	127	254	127	2.4	32	1	M100580	OE replacement		
		5.0	10.0	5.0	127	254	127	2.5	35	1	M100807	60" (1524mm) Long Body		
		5.0	10.0	5.0	127	254	127	1.9	26	1	M100944	OE replacement for higher HP		
		5.0	10.0	5.0	127	254	127	2.3	31	1	M101158	Silent Partner Stainless		
		5.0	10.0	5.0	127	254	127	2.3	31	1	M101181	Silent Partner Aluminized		
		5.0	10.0	5.0	127	254	127	2.4	32	1	M101263	Freightliner only		
		5.0	11.0	5.0	127	279	127	1.9	25	1	M110849			
		ISX	400	5.0	9.0	5.0	127	229	127	2.0	27	1	M090074	
				5.0	9.0	5.0	127	229	127	1.1	15	1	M090535	Low backpressure, off-hwy
				4.0	9.0	5.0	102	229	127	2.4	32	1	M090781	
5.0	10.0			5.0	127	254	127	1.1	15	1	M100463	Low backpressure, off-hwy		
5.0	10.0			5.0	127	254	127	2.1	29	1	M100465	Best value, most popular		
5.0	10.0			5.0	127	254	127	2.3	31	1	M100580	OE replacement		
5.0	10.0			5.0	127	254	127	2.4	33	1	M100807	60" (1524mm) Long Body		

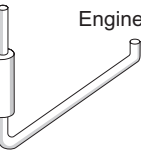
Engine Make & Exhaust System Configuration	Engine Model	H.P.	Muffler Dimensions						Backpressure		Muffler Style & Part No.	Notes	
			inches			mm			inches of Hg	H ₂ O			
			Inlet	Body	Outlet	Inlet	Body	Outlet					
			5.0	10.0	5.0	127	254	127	1.8	24	1	M100944	OE replacement for higher HP
			5.0	10.0	5.0	127	254	127	2.2	29	1	M101158	Silent Partner Stainless
			5.0	10.0	5.0	127	254	127	2.2	29	1	M101181	Silent Partner Aluminized
			5.0	10.0	5.0	127	254	127	2.3	31	1	M101263	Freightliner only
ISX	450 to 475	5.0	11.0	5.0	127	279	127	1.8	24	1	M110849		
		5.0	9.0	5.0	127	229	127	2.6	35	1	M090074		
		5.0	9.0	5.0	127	229	127	1.4	19	1	M090535	Low backpressure, off-hwy	
		5.0	10.0	5.0	127	254	127	1.4	19	1	M100463	Low backpressure, off-hwy	
		5.0	10.0	5.0	127	254	127	2.8	37	1	M100465	Best value, most popular	
		5.0	10.0	5.0	127	254	127	2.9	40	1	M100580	OE replacement	
		5.0	10.0	5.0	127	254	127	2.3	31	1	M100944	OE replacement for higher HP	
		5.0	10.0	5.0	127	254	127	2.8	38	1	M101158	Silent Partner Stainless	
		5.0	10.0	5.0	127	254	127	2.8	38	1	M101181	Silent Partner Aluminized	
		5.0	10.0	5.0	127	254	127	2.9	40	1	M101263	Freightliner only	
		5.0	11.0	5.0	127	279	127	2.3	31	1	M110849		
ISX	500	5.0	9.0	5.0	127	229	127	2.8	38	1	M090074		
		5.0	9.0	5.0	127	229	127	1.5	20	1	M090535	Low backpressure, off-hwy	
		5.0	10.0	5.0	127	254	127	1.5	20	1	M100463	Low backpressure, off-hwy	
		5.0	10.0	5.0	127	254	127	2.9	40	1	M100465	Best value, most popular	
		5.0	10.0	5.0	127	254	127	2.5	34	1	M100944	OE replacement for higher HP	
		5.0	11.0	5.0	127	279	127	2.5	34	1	M110849		
ISX	600	5.0	9.0	5.0	127	229	127	2.0	27	1	M090535	Low backpressure, off-hwy	
		5.0	10.0	5.0	127	254	127	2.0	27	1	M100463	Low backpressure, off-hwy	
L10	260 to 280	4.0	8.5	4.0	102	216	102	0.6	8	1	M085171		
		4.0	9.0	5.0	102	229	127	0.5	6	1	M090781		
		5.0	9.0	5.0	127	229	127	0.7	10	1	M090074		
		5.0	10.0	5.0	127	254	127	0.8	11	1	M100465	Best value, most popular	
		5.0	10.0	5.0	127	254	127	0.8	11	1	M100580	OE replacement	
		5.0	10.0	5.0	127	254	127	0.9	12	1	M100807	60" (1524mm) Long Body	
		5.0	10.0	5.0	127	254	127	0.8	11	1	M101158		
		5.0	10.0	5.0	127	254	127	0.8	11	1	M101181	Silent Partner Aluminized	
		5.0	10.0	5.0	127	254	127	0.8	11	1	M101263	Freightliner only	
		5.0	10.0	5.0	127	254	127	0.7	9	1	M110944		
		5.0	11.0	5.0	127	279	127	0.7	9	1	M110849		
L10	300 to 375	4.0	8.5	4.0	102	216	102	0.5	7	1	M085171		
		4.0	9.0	5.0	102	229	127	0.4	5	1	M090781		
		5.0	9.0	5.0	127	229	127	0.6	9	1	M090074		
		5.0	10.0	5.0	127	254	127	0.7	9	1	M100465	Best value, most popular	
		5.0	10.0	5.0	127	254	127	0.7	10	1	M100580	OE replacement	
		5.0	10.0	5.0	127	254	127	0.8	11	1	M100807	60" (1524mm) Long Body	
		5.0	10.0	5.0	127	254	127	0.7	9	1	M101158		
		5.0	10.0	5.0	127	254	127	0.7	9	1	M101181	Silent Partner Aluminized	
		5.0	10.0	5.0	127	254	127	0.7	10	1	M101263	Freightliner only	
		5.0	11.0	5.0	127	279	127	0.6	8	1	M110849		
		M11	400	4.0	8.5	4.0	102	216	102	1.0	13	1	M085171
4.0	9.0			5.0	102	229	127	1.4	19	1	M090781		
5.0	9.0			5.0	127	229	127	1.2	16	1	M090074		
5.0	9.0			5.0	127	229	127	0.6	8	1	M090535	Low backpressure, off-hwy	
5.0	10.0			5.0	127	254	127	0.6	8	1	M100463	Low backpressure, off-hwy	
5.0	10.0			5.0	127	254	127	1.2	17	1	M100465	Best value, most popular	
5.0	10.0			5.0	127	254	127	1.3	18	1	M100580	OE replacement	
5.0	10.0			5.0	127	254	127	1.4	19	1	M100807	60" (1524mm) Long Body	
5.0	10.0			5.0	127	254	127	1.0	14	1	M100944	OE replacement for higher HP	
5.0	10.0			5.0	127	254	127	1.2	17	1	M101158	Silent Partner Stainless	
5.0	10.0			5.0	127	254	127	1.2	17	1	M101181	Silent Partner Aluminized	
5.0	10.0			5.0	127	254	127	1.3	18	1	M101263	Freightliner only	
5.0	11.0			5.0	127	279	127	1.0	14	1	M110849		
N14	330	4.0	8.5	4.0	102	216	102	1.4	19	1	M085171		
		4.0	9.0	5.0	102	229	127	1.9	26	1	M090781		
		5.0	9.0	5.0	127	229	127	1.6	22	1	M090074		
		5.0	9.0	5.0	127	229	127	0.9	12	1	M090535	Low backpressure, off-hwy	
		5.0	10.0	5.0	127	254	127	0.9	12	1	M100463	Low backpressure, off-hwy	
		5.0	10.0	5.0	127	254	127	1.7	24	1	M100465	Best value, most popular	
		5.0	10.0	5.0	127	254	127	1.8	25	1	M100580	OE replacement	
		5.0	10.0	5.0	127	254	127	2.0	27	1	M100807	60" (1524mm) Long Body	
		5.0	10.0	5.0	127	254	127	1.5	20	1	M100944	OE replacement for higher HP	
		5.0	10.0	5.0	127	254	127	1.8	24	1	M101158	Silent Partner Stainless	
		5.0	10.0	5.0	127	254	127	1.8	24	1	M101181	Silent Partner Aluminized	
		5.0	10.0	5.0	127	254	127	1.8	25	1	M101263	Freightliner only	
		5.0	11.0	5.0	127	279	127	1.5	20	1	M110849		

Truck Engine Muffler Application

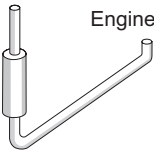
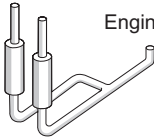

TRUCK ENGINE APPL.

Engine Make & Exhaust System Configuration	Engine Model	Engine H.P.	Muffler Dimensions						Backpressure		Muffler Style & Part No.	Notes		
			inches			mm			inches of Hg	H ₂ O				
			Inlet	Body	Outlet	Inlet	Body	Outlet						
 Engine	N14	350 to 435	4.0	8.5	4.0	102	216	102	2.2	30	1	M085171		
			5.0	9.0	5.0	127	229	127	2.7	36	1	M090074		
			5.0	9.0	5.0	127	229	127	1.4	19	1	M090535	Low backpressure, off-hwy	
			5.0	10.0	5.0	127	254	127	1.4	19	1	M100463	Low backpressure, off-hwy	
			5.0	10.0	5.0	127	254	127	2.9	40	1	M100580	OE replacement	
			5.0	10.0	5.0	127	254	127	2.8	39	1	M100465	Best value, most popular	
			5.0	10.0	5.0	127	254	127	2.4	32	1	M100944	OE replacement for higher HP	
			5.0	10.0	5.0	127	254	127	2.9	39	1	M101158	Silent Partner Stainless	
				5.0	10.0	5.0	127	254	127	2.9	39	1	M101181	Silent Partner Aluminized
				5.0	11.0	5.0	127	279	127	2.4	32	1	M110849	
		N14	460	5.0	9.0	5.0	127	229	127	2.9	39	1	M090074	
	5.0			9.0	5.0	127	229	127	1.5	21	1	M090535	Low backpressure, off-hwy	
	5.0			10.0	5.0	127	254	127	1.5	21	1	M100463	Low backpressure, off-hwy	
	5.0			10.0	5.0	127	254	127	2.6	35	1	M100944	OE replacement for higher HP	
	5.0			11.0	5.0	127	279	127	2.6	35	1	M110849		
		N14	500 to 550	5.0	9.0	5.0	127	229	127	1.8	25	1	M090535	Low backpressure, off-hwy
	5.0			10.0	5.0	127	254	127	1.8	25	1	M100463	Low backpressure, off-hwy	
		NTC	400	4.0	8.5	4.0	102	216	102	2.5	34	1	M085171	
	5.0			9.0	5.0	127	229	127	1.6	22	1	M090535	Low backpressure, off-hwy	
	5.0			10.0	5.0	127	254	127	1.6	22	1	M100463	Low backpressure, off-hwy	
	5.0			10.0	5.0	127	254	127	2.7	37	1	M100944	OE replacement for higher HP	
	5.0			11.0	5.0	127	279	127	2.7	36	1	M110849		
		Signature	500	4.0	8.5	4.0	102	216	102	2.2	30	1	M085171	
	5.0			9.0	5.0	127	229	127	2.6	36	1	M090074		
	5.0			9.0	5.0	127	229	127	1.4	19	1	M090535	Low backpressure, off-hwy	
	5.0			10.0	5.0	127	254	127	1.4	19	1	M100463	Low backpressure, off-hwy	
	5.0			10.0	5.0	127	254	127	2.8	38	1	M100465	Best value, most popular	
	5.0			10.0	5.0	127	254	127	2.9	40	1	M100580	OE replacement	
5.0	10.0			5.0	127	254	127	2.3	32	1	M100944	OE replacement for higher HP		
5.0	10.0			5.0	127	254	127	2.8	39	1	M101158	Silent Partner Stainless		
5.0	10.0			5.0	127	254	127	2.8	39	1	M101181	Silent Partner Aluminized		
5.0	10.0			5.0	127	254	127	2.9	40	1	M101263	Freightliner only		
			5.0	11.0	5.0	127	279	127	2.3	32	1	M110849		
	Signature	565	4.0	8.5	4.0	102	216	102	2.4	33	1	M085171		
5.0			9.0	5.0	127	229	127	2.9	39	1	M090074			
5.0			9.0	5.0	127	229	127	1.5	21	1	M090535	Low backpressure, off-hwy		
5.0			10.0	5.0	127	254	127	1.5	21	1	M100463	Low backpressure, off-hwy		
5.0			10.0	5.0	127	254	127	2.6	35	1	M100944	OE replacement for higher HP		
	Signature	600	4.0	8.5	4.0	102	216	102	2.7	37	1	M085171		
5.0			9.0	5.0	127	229	127	1.8	24	1	M090535	Low backpressure, off-hwy		
5.0			10.0	5.0	127	254	127	1.8	24	1	M100463	Low backpressure, off-hwy		
5.0			10.0	5.0	127	254	127	2.9	40	1	M100944	OE replacement for higher HP		
5.0			11.0	5.0	127	279	127	2.9	40	1	M110849			
 Engine	ISM	310 to 350	4.0	9.0	4.0	102	229	102	0.7	10	1	M090544		
			4.0	10.0	4.0	102	254	102	0.8	10	1	M100466		
			4.0	10.0	5.0	102	254	127	1.2	17	1	M100695		
			4.0	10.3	4.0	102	262	102	1.4	20	1	M100464	Wrapped muffler	
			5.0	10.0	5.0	127	254	127	0.9	13	1	M100582	OE replacement	
			5.0	10.0	5.0	127	254	127	0.9	13	1	M101159	Silent Partner Stainless	
			5.0	10.0	5.0	127	254	127	0.9	13	1	M101182	Silent Partner Aluminized	
				ISM	370 to 450	4.0	9.0	4.0	102	229	102	0.9	12	1
	4.0	10.0	4.0			102	254	102	0.9	13	1	M100466		
	4.0	10.0	5.0			102	254	127	1.5	21	1	M100695		
	4.0	10.3	4.0			102	262	102	1.8	24	1	M100464	Wrapped muffler	
	5.0	10.0	5.0			127	254	127	1.2	16	1	M100582	OE replacement	
	5.0	10.0	5.0			127	254	127	1.2	16	1	M101159	Silent Partner Stainless	
	5.0	10.0	5.0			127	254	127	1.2	16	1	M101182	Silent Partner Aluminized	
		ISM	500			4.0	9.0	4.0	102	229	102	1.0	14	1
	4.0			10.3	4.0	102	262	102	2.1	28	1	M100464	Wrapped muffler	
	4.0			10.0	4.0	102	254	102	1.1	15	1	M100466		
	5.0			10.0	5.0	127	254	127	1.3	18	1	M100582	OE replacement	
	4.0			10.0	5.0	102	254	127	1.7	24	1	M100695		
	5.0			10.0	5.0	127	254	127	1.3	18	1	M101159	Silent Partner Stainless	
	5.0			10.0	5.0	127	254	127	1.3	18	1	M101182	Silent Partner Aluminized	
		ISX	400 to 500	4.0	9.0	4.0	102	229	102	1.4	19	1	M090544	
	4.0			10.0	4.0	102	254	102	1.5	20	1	M100466		
	4.0			10.0	5.0	102	254	127	2.3	31	1	M100695		
	4.0			10.3	4.0	102	262	102	2.7	37	1	M100464	Wrapped muffler	

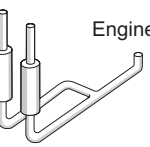
Engine Make & Exhaust System Configuration	Engine Model	H.P.	Muffler Dimensions inches			Muffler Dimensions mm			Backpressure inches of Hg H ₂ O		Muffler Style & Part No.	Notes	
			Inlet	Body	Outlet	Inlet	Body	Outlet	Hg	H ₂ O			
	ISX	600	5.0	10.0	5.0	127	254	127	1.8	24	1	M100582	OE replacement
			5.0	10.0	5.0	127	254	127	1.8	24	1	M101159	Silent Partner Stainless
			5.0	10.0	5.0	127	254	127	1.8	24	1	M101182	Silent Partner Aluminized
			4.0	9.0	4.0	102	229	102	1.8	25	1	M090544	
			4.0	10.0	4.0	102	254	102	1.9	26	1	M100466	
			5.0	10.0	5.0	127	254	127	2.4	32	1	M100582	OE replacement
	L10	260 to 280	5.0	10.0	5.0	127	254	127	2.4	32	1	M101159	Silent Partner Stainless
			5.0	10.0	5.0	127	254	127	2.4	32	1	M101182	Silent Partner Aluminized
			4.0	9.0	4.0	102	229	102	0.4	5	1	M090544	
			4.0	10.0	4.0	102	254	102	0.4	5	1	M100466	
			4.0	10.0	5.0	102	254	127	0.6	8	1	M100695	
			4.0	10.3	4.0	102	262	102	0.7	10	1	M100464	Wrapped muffler
	L10	300-375	5.0	10.0	5.0	127	254	127	0.5	6	1	M100582	OE replacement
			5.0	10.0	5.0	127	254	127	0.5	6	1	M101182	Silent Partner Aluminized
			5.0	10.0	5.0	127	254	127	0.5	6	1	M101159	Silent Partner Stainless
			4.0	9.0	4.0	102	229	102	0.4	5	1	M090544	
			4.0	10.0	4.0	102	254	102	0.4	6	1	M100466	
			4.0	10.0	5.0	102	254	127	0.7	9	1	M100695	
M11	400	4.0	10.3	4.0	102	262	102	0.8	11	1	M100464	Wrapped muffler	
		5.0	10.0	5.0	127	254	127	0.5	7	1	M100582	OE replacement	
		5.0	10.0	5.0	127	254	127	0.5	7	1	M101182	Silent Partner Aluminized	
		5.0	10.0	5.0	127	254	127	0.5	7	1	M101159	Silent Partner Stainless	
		4.0	9.0	4.0	102	229	102	0.6	8	1	M090544		
		4.0	10.0	5.0	102	254	127	1.0	13	1	M100695		
N14	330 to 350	4.0	10.3	4.0	102	262	102	1.1	15	1	M100464	Wrapped muffler	
		5.0	10.0	5.0	127	254	127	0.7	10	1	M100582	OE replacement	
		5.0	10.0	5.0	127	254	127	0.7	10	1	M101159	Silent Partner Stainless	
		5.0	10.0	5.0	127	254	127	0.7	10	1	M101182	Silent Partner Aluminized	
		4.0	9.0	4.0	102	229	102	1.1	15	1	M090544		
		4.0	10.0	4.0	102	254	102	1.2	16	1	M100466		
N14	370 to 410	4.0	10.0	5.0	102	254	127	1.9	25	1	M100695		
		4.0	10.3	4.0	102	262	102	2.2	30	1	M100464	Wrapped muffler	
		5.0	10.0	5.0	127	254	127	1.4	19	1	M100582	OE replacement	
		5.0	10.0	5.0	127	254	127	1.4	19	1	M101159	Silent Partner Stainless	
		5.0	10.0	5.0	127	254	127	1.4	19	1	M101182	Silent Partner Aluminized	
		4.0	9.0	4.0	102	229	102	1.2	17	1	M090544		
N14	435 to 460	4.0	10.0	4.0	102	254	102	1.3	18	1	M100466		
		4.0	10.0	5.0	102	254	127	2.1	29	1	M100695		
		4.0	10.3	4.0	102	262	102	2.5	34	1	M100464	Wrapped muffler	
		5.0	10.0	5.0	127	254	127	1.6	22	1	M100582	OE replacement	
		5.0	10.0	5.0	127	254	127	1.6	22	1	M101159	Silent Partner Stainless	
		5.0	10.0	5.0	127	254	127	1.6	22	1	M101182	Silent Partner Aluminized	
N14	500 to 550	4.0	9.0	4.0	102	229	102	1.4	19	1	M090544		
		4.0	10.0	4.0	102	254	102	1.5	20	1	M100466		
		4.0	10.0	5.0	102	254	127	2.4	32	1	M100695		
		4.0	10.3	4.0	102	262	102	2.8	38	1	M100464	Wrapped muffler	
		5.0	10.0	5.0	127	254	127	1.8	25	1	M100582	OE replacement	
		5.0	10.0	5.0	127	254	127	1.8	25	1	M101159	Silent Partner Stainless	
NTC	400	5.0	10.0	5.0	127	254	127	1.8	25	1	M101182	Silent Partner Aluminized	
		4.0	9.0	4.0	102	229	102	1.7	23	1	M090544		
		4.0	10.0	4.0	102	254	102	1.8	24	1	M100466		
		4.0	10.0	5.0	102	254	127	2.9	39	1	M100695		
		5.0	10.0	5.0	127	254	127	2.2	30	1	M100582	OE replacement	
		5.0	10.0	5.0	127	254	127	2.2	30	1	M101159	Silent Partner Stainless	
Signature	500 to 600	5.0	10.0	5.0	127	254	127	2.2	30	1	M101182	Silent Partner Aluminized	
		4.0	9.0	4.0	102	229	102	1.6	22	1	M090544		
		4.0	10.0	4.0	102	254	102	1.7	23	1	M100466		
		4.0	10.0	5.0	102	254	127	2.7	37	1	M100695		
		5.0	10.0	5.0	127	254	127	2.1	29	1	M100582	OE replacement	
		5.0	10.0	5.0	127	254	127	2.1	29	1	M101159	Silent Partner Stainless	
5.0	10.0	5.0	127	254	127	2.1	29	1	M101182	Silent Partner Aluminized			

Truck Engine Muffler Application

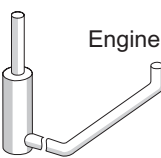
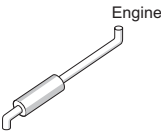

TRUCK ENGINE APPL.

Engine Make & Exhaust System Configuration	Engine Model	Engine H.P.	Muffler Dimensions						Backpressure		Muffler Style & Part No.	Notes				
			inches			mm			inches of Hg	inches of H ₂ O						
			Inlet	Body	Outlet	Inlet	Body	Outlet								
 Engine	6BT	230	4.0	9.0	5.0	102	229	127	1.1	15	3	M090823				
			4.0	11.8	5.0	102	300	127	1.2	16	3	M120598				
			5.0	10.0	5.0	127	254	127	1.1	14	3	M100213				
	6CT	300	4.0	9.0	5.0	102	229	127	2.3	31	3	M090823				
			4.0	11.8	5.0	102	300	127	2.4	32	3	M120598				
			5.0	10.0	5.0	127	254	127	2.1	29	3	M100213				
	6CT	250	4.0	9.0	5.0	102	229	127	1.6	21	3	M090823				
			4.0	11.8	5.0	102	300	127	1.7	22	3	M120598				
			5.0	10.0	5.0	127	254	127	1.5	20	3	M100213				
	ISB	185 to 225	4.0	9.0	5.0	102	229	127	1.0	13	3	M090823				
			4.0	10.0	4.0	102	254	102	2.8	38	3	M100146				
			4.0	11.8	5.0	102	300	127	1.0	14	3	M120598				
			5.0	10.0	5.0	127	254	127	0.9	12	3	M100213				
	ISB	240 to 300	4.0	9.0	5.0	102	229	127	1.4	20	3	M090823				
			4.0	11.8	5.0	102	300	127	1.5	21	3	M120598				
			5.0	10.0	5.0	127	254	127	1.3	18	3	M100213				
	ISC	225 to 315	4.0	9.0	5.0	102	229	127	1.8	24	3	M090823				
			4.0	11.8	5.0	102	300	127	1.8	25	3	M120598				
			5.0	10.0	5.0	127	254	127	1.6	22	3	M100213				
	ISC	330	4.0	9.0	5.0	102	229	127	1.8	25	3	M090823				
			4.0	11.8	5.0	102	300	127	1.9	26	3	M120598				
			5.0	10.0	5.0	127	254	127	1.7	23	3	M100213				
	ISC	350	4.0	9.0	5.0	102	229	127	2.0	27	3	M090823				
			4.0	11.8	5.0	102	300	127	2.1	28	3	M120598				
			5.0	10.0	5.0	127	254	127	1.8	25	3	M100213				
	ISM	310 to 330	4.0	9.0	5.0	102	229	127	1.8	24	3	M090823				
			4.0	11.8	5.0	102	300	127	1.9	25	3	M120598				
			5.0	10.0	5.0	127	254	127	1.7	23	3	M100213				
	ISM	350 to 425	4.0	9.0	5.0	102	229	127	2.7	37	3	M090823				
			4.0	11.8	5.0	102	300	127	2.9	39	3	M120598				
			5.0	10.0	5.0	127	254	127	2.6	35	3	M100213				
	ISM	450	4.0	9.0	5.0	102	229	127	2.9	39	3	M090823				
			5.0	10.0	5.0	127	254	127	2.7	36	3	M100213				
	ISX	400	5.0	10.0	5.0	127	254	127	2.9	40	3	M100213				
	L10	260 to 280	4.0	9.0	5.0	102	229	127	1.2	16	3	M090823				
			4.0	11.8	5.0	102	300	127	1.2	17	3	M120598				
			5.0	10.0	5.0	127	254	127	1.1	15	3	M100213				
	L10	300 to 375	4.0	9.0	5.0	102	229	127	1.3	17	3	M090823				
			4.0	11.8	5.0	102	300	127	1.3	18	3	M120598				
			5.0	10.0	5.0	127	254	127	1.2	16	3	M100213				
	M11	400	4.0	9.0	5.0	102	229	127	1.8	25	3	M090823				
			4.0	11.8	5.0	102	300	127	1.9	26	3	M120598				
			5.0	10.0	5.0	127	254	127	1.7	23	3	M100213				
	NTC	255 to 290	4.0	9.0	5.0	102	229	127	1.6	21	3	M090823				
			4.0	11.8	5.0	102	300	127	1.7	23	3	M120598				
			5.0	10.0	5.0	127	254	127	1.5	20	3	M100213				
	NTC	300 to 350	4.0	9.0	5.0	102	229	127	2.6	36	3	M090823				
			4.0	11.8	5.0	102	300	127	2.8	38	3	M120598				
			5.0	10.0	5.0	127	254	127	2.5	33	3	M100213				
 Engine	6BT	230	3.0	11.0	4.0	76	279	102	1.2	16	1	M111029	OE replacement			
			4.0	10.0	4.0	102	254	102	2.0	27	2	M100048	Aftermarket			
			4.0	11.0	4.0	102	279	102	1.9	26	2	M110012				
			4.0	11.0	4.0	102	279	102	1.7	24	2	M110189	OE replacement			
			4.0	11.0	5.0	102	279	127	1.0	14	2	M111028	Inlet dimension is OD			
			4.0	10x15	4.0	102	254x381	102	1.4	20	2	M120100	Aftermarket, shorter than OE			
			4.0	8.3x11.5	4.0	102	211x292	102	1.9	26	2	M090280	Aftermarket, shorter than OE			
			4.0	8.3x11.5	4.0	102	211x292	102	1.8	25	2	M090534	Aftermarket, shorter than OE			
			5.0	10x15	5.0	127	254x381	127	1.1	14	2	M120108	For off-hwy, shorter than OE			
			5.0	10x15	5.0	127	254x381	127	1.1	15	2	M120365	Aftermarket			
			5.0	10x15	5.0	127	254x381	127	1.2	16	2	M120448	OE replacement			
				6CT	250	4.0	8.3x11.5	4.0	102	211x292	102	2.7	37	2	M090280	Aftermarket, shorter than OE
						3.0	11.0	4.0	76	279	102	1.7	23	1	M111029	OE replacement
4.0	10.0	4.0				102	254	102	2.7	37	2	M100048	Aftermarket			
4.0	11.0	4.0				102	279	102	2.7	36	2	M110012				

Engine Make & Exhaust System Configuration	Engine Model	H.P.	Muffler Dimensions inches			Muffler Dimensions mm			Backpressure inches of Hg H ₂ O		Muffler Style & Part No.	Notes
			Inlet	Body	Outlet	Inlet	Body	Outlet	Hg	H ₂ O		

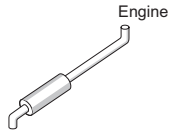

6CT	300	4.0	11.0	4.0	102	279	102	2.4	33	2	M110189	OE replacement		
		4.0	11.0	5.0	102	279	127	1.4	19	2	M111028	Inlet dimension is OD		
		4.0	10x15	4.0	102	254x381	102	2.0	27	2	M120100	Aftermarket, shorter than OE		
		4.0	8.3x11.5	4.0	102	211x292	102	2.5	34	2	M090534	Aftermarket, shorter than OE		
		5.0	10x15	5.0	127	254x381	127	1.5	20	2	M120108	For off-hwy, shorter than OE		
		5.0	10x15	5.0	127	254x381	127	1.0	13	2	M120225	For off-hwy, shorter than OE		
		5.0	10x15	5.0	127	254x381	127	1.6	21	2	M120365	Aftermarket		
6CT	300	5.0	10x15	5.0	127	254x381	127	1.6	22	2	M120448	OE replacement		
		3.0	11.0	4.0	76	279	102	2.4	33	1	M111029	OE replacement		
		4.0	11.0	5.0	102	279	127	2.0	27	2	M111028	Inlet dimension is OD		
		4.0	10x15	4.0	102	254x381	102	2.9	39	2	M120100	Aftermarket, shorter than OE		
		5.0	10x15	5.0	127	254x381	127	2.1	29	2	M120108	For off-hwy, shorter than OE		
		5.0	10x15	5.0	127	254x381	127	1.4	19	2	M120225	For off-hwy, shorter than OE		
		5.0	10x15	5.0	127	254x381	127	2.2	31	2	M120365	Aftermarket		
ISB	185 to 225	5.0	10x15	5.0	127	254x381	127	2.3	32	2	M120448	OE replacement		
		6.0	10x15	6.0	152	254x381	152	1.2	16	2	M122300	For off-hwy, shorter than OE		
		3.0	11.0	4.0	76	279	102	1.0	14	1	M111029	OE replacement		
		3.5	8.3x11.5	3.5	89	211x292	89	2.8	38	2	M090158			
		3.5	8.5x11.8	3.5	89	216x300	89	2.8	38	2	M090210	Wrapped muffler		
		4.0	10.0	4.0	102	254	102	1.7	23	2	M100048	Aftermarket		
		4.0	11.0	4.0	102	279	102	1.7	23	2	M110012			
ISB	185 to 225	4.0	11.0	4.0	102	279	102	1.5	20	2	M110189	OE replacement		
		4.0	11.0	5.0	102	279	127	0.9	12	2	M111028	Inlet dimension is OD		
		4.0	10.3x15.3	4.0	102	261x389	102	2.6	35	2	M120197	Wrapped muffler, OE		
		4.0	10x15	4.0	102	254x381	102	1.2	17	2	M120100	Aftermarket, shorter than OE		
		4.0	8.3x11.5	4.0	102	211x292	102	1.7	23	2	M090280	Aftermarket, shorter than OE		
		4.0	8.3x11.5	4.0	102	211x292	102	1.6	21	2	M090534	Aftermarket, shorter than OE		
		4.0	8.3x11.5	3.5	102	211x292	89	2.8	37	2	M090538			
		5.0	10x15	5.0	127	254x381	127	0.9	12	2	M120108	For off-hwy, shorter than OE		
		5.0	10x15	5.0	127	254x381	127	1.0	13	2	M120365	Aftermarket		
		5.0	10x15	5.0	127	254x381	127	1.0	14	2	M120448	OE replacement		
		ISB	240 to 300	3.0	11.0	4.0	76	279	102	1.5	21	1	M111029	OE replacement
				4.0	10.0	4.0	102	254	102	2.5	34	2	M100048	Aftermarket
				4.0	11.0	4.0	102	279	102	2.4	33	2	M110012	
				4.0	11.0	4.0	102	279	102	2.2	30	2	M110189	OE replacement
4.0	11.0			5.0	102	279	127	1.3	17	2	M111028	Inlet dimension is OD		
4.0	10x15			4.0	102	254x381	102	1.8	25	2	M120100	Aftermarket, shorter than OE		
4.0	8.3x11.5			4.0	102	211x292	102	2.5	34	2	M090280	Aftermarket, shorter than OE		
4.0	8.3x11.5			4.0	102	211x292	102	2.3	32	2	M090534	Aftermarket, shorter than OE		
5.0	10x15			5.0	127	254x381	127	1.4	18	2	M120108	For off-hwy, shorter than OE		
5.0	10x15			5.0	127	254x381	127	1.4	20	2	M120365	Aftermarket		
5.0	10x15			5.0	127	254x381	127	1.5	20	2	M120448	OE replacement		
ISC	225 to 240	3.0	11.0	4.0	76	279	102	1.6	22	1	M111029	OE replacement		
		4.0	10.0	4.0	102	254	102	2.7	36	2	M100048	Aftermarket		
		4.0	11.0	4.0	102	279	102	2.6	35	2	M110012			
		4.0	11.0	4.0	102	279	102	2.3	32	2	M110189	OE replacement		
		4.0	11.0	5.0	102	279	127	1.4	18	2	M111028	Inlet dimension is OD		
		4.0	10x15	4.0	102	254x381	102	1.9	26	2	M120100	Aftermarket, shorter than OE		
		4.0	8.3x11.5	4.0	102	211x292	102	2.6	35	2	M090280	Aftermarket, shorter than OE		
		4.0	8.3x11.5	4.0	102	211x292	102	2.4	33	2	M090534	Aftermarket, shorter than OE		
		5.0	10x15	5.0	127	254x381	127	1.4	19	2	M120108	For off-hwy, shorter than OE		
		5.0	10x15	5.0	127	254x381	127	1.5	21	2	M120365	Aftermarket		
		5.0	10x15	5.0	127	254x381	127	1.6	21	2	M120448	OE replacement		
ISC	260 to 300	3.0	11.0	4.0	76	279	102	1.6	22	1	M111029	OE replacement		
		4.0	10.0	4.0	102	254	102	2.7	37	2	M100048	Aftermarket		
		4.0	11.0	4.0	102	279	102	2.6	36	2	M110012			
		4.0	11.0	4.0	102	279	102	2.4	32	2	M110189	OE replacement		
		4.0	11.0	5.0	102	279	127	1.4	19	2	M111028	Inlet dimension is OD		
		4.0	10x15	4.0	102	254x381	102	2.0	27	2	M120100	Aftermarket, shorter than OE		
		4.0	8.3x11.5	4.0	102	211x292	102	2.7	36	2	M090280	Aftermarket, shorter than OE		
		4.0	8.3x11.5	4.0	102	211x292	102	2.5	34	2	M090534	Aftermarket, shorter than OE		
		5.0	10x15	5.0	127	254x381	127	1.5	20	2	M120108	For off-hwy, shorter than OE		
		5.0	10x15	5.0	127	254x381	127	1.5	21	2	M120365	Aftermarket		
		5.0	10x15	5.0	127	254x381	127	1.6	22	2	M120448	OE replacement		

TRUCK ENGINE APPL.

Truck Engine Muffler Application



TRUCK ENGINE APPL.

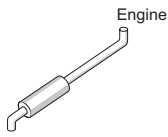

Engine Make & Exhaust System Configuration	Engine Model	Engine H.P.	Muffler Dimensions						Backpressure		Muffler Style & Part No.	Notes
			inches			mm			inches of Hg	H ₂ O		
			Inlet	Body	Outlet	Inlet	Body	Outlet				
ISC	315 to 330	3.0	11.0	4.0	76	279	102	2.0	27	1	M111029	OE replacement
		4.0	11.0	4.0	102	279	102	2.8	39	2	M110189	OE replacement
		4.0	11.0	5.0	102	279	127	1.6	22	2	M111028	Inlet dimension is OD
		4.0	10x15	4.0	102	254x381	102	2.4	32	2	M120100	Aftermarket, shorter than OE
		4.0	8.3x11.5	4.0	102	211x292	102	3.0	40	2	M090534	Aftermarket, shorter than OE
		5.0	10x15	5.0	127	254x381	127	1.7	24	2	M120108	For off-hwy, shorter than OE
		5.0	10x15	5.0	127	254x381	127	1.8	25	2	M120365	Aftermarket
		5.0	10x15	5.0	127	254x381	127	1.9	26	2	M120448	OE replacement
ISC	350	3.0	11.0	4.0	76	279	102	2.1	28	1	M111029	OE replacement
		4.0	11.0	5.0	102	279	127	1.8	24	2	M111028	Inlet dimension is OD
		4.0	10x15	4.0	102	254x381	102	2.5	34	2	M120100	Aftermarket, shorter than OE
		5.0	10x15	5.0	127	254x381	127	1.9	25	2	M120108	For off-hwy, shorter than OE
		5.0	10x15	5.0	127	254x381	127	2.0	27	2	M120365	Aftermarket
		5.0	10x15	5.0	127	254x381	127	2.0	28	2	M120448	OE replacement
ISM	310 to 330	3.0	11.0	4.0	76	279	102	1.9	26	1	M111029	OE replacement
		4.0	11.0	4.0	102	279	102	2.7	37	2	M110189	OE replacement
		4.0	11.0	5.0	102	279	127	1.6	22	2	M111028	Inlet dimension is OD
		4.0	10x15	4.0	102	254x381	102	2.3	31	2	M120100	Aftermarket, shorter than OE
		4.0	8.3x11.5	4.0	102	211x292	102	2.9	39	2	M090534	Aftermarket, shorter than OE
		5.0	10x15	5.0	127	254x381	127	1.7	23	2	M120108	For off-hwy, shorter than OE
		5.0	10x15	5.0	127	254x381	127	1.8	24	2	M120365	Aftermarket
		5.0	10x15	5.0	127	254x381	127	1.8	25	2	M120448	OE replacement
ISM	350 to 450	4.0	11.0	5.0	102	279	127	2.5	35	2	M111028	Inlet dimension is OD
		5.0	10x15	5.0	127	254x381	127	2.7	37	2	M120108	For off-hwy, shorter than OE
		5.0	10x15	5.0	127	254x381	127	1.8	24	2	M120225	For off-hwy, shorter than OE
		5.0	10x15	5.0	127	254x381	127	2.8	39	2	M120365	Aftermarket
		5.0	10x15	5.0	127	254x381	127	2.9	40	2	M120448	OE replacement
		6.0	10x15	6.0	152	254x381	152	1.5	20	2	M122300	For off-hwy, shorter than OE
ISM	500	5.0	10x15	5.0	127	254x381	127	2.0	28	2	M120225	For off-hwy, shorter than OE
		4.0	11.0	5.0	102	279	127	2.9	40	2	M111028	Inlet dimension is OD
		6.0	10x15	6.0	152	254x381	152	1.7	23	2	M122300	For off-hwy, shorter than OE
ISX	400	4.0	11.0	5.0	102	279	127	2.8	38	2	M111028	Inlet dimension is OD
		5.0	10x15	5.0	127	254x381	127	2.9	40	2	M120108	For off-hwy, shorter than OE
		5.0	10x15	5.0	127	254x381	127	1.9	26	2	M120225	For off-hwy, shorter than OE
		6.0	10x15	6.0	152	254x381	152	1.6	22	2	M122300	For off-hwy, shorter than OE
ISX	450 to 500	5.0	10x15	5.0	127	254x381	127	2.7	37	2	M120225	For off-hwy, shorter than OE
		6.0	10x15	6.0	152	254x381	152	2.2	30	2	M122300	For off-hwy, shorter than OE
ISX	600	6.0	10x15	6.0	152	254x381	152	3.0	40	2	M122300	For off-hwy, shorter than OE
L10	260 to 280	3.0	11.0	4.0	76	279	102	1.2	17	1	M111029	OE replacement
		4.0	10.0	4.0	102	254	102	2.0	28	2	M100048	Aftermarket
		4.0	11.0	4.0	102	279	102	2.0	27	2	M110012	
		4.0	11.0	4.0	102	279	102	1.8	24	2	M110189	OE replacement
		4.0	11.0	5.0	102	279	127	1.0	14	2	M111028	Inlet dimension is OD
		4.0	10x15	4.0	102	254x381	102	1.5	20	2	M120100	Aftermarket, shorter than OE
		4.0	8.3x11.5	4.0	102	211x292	102	2.0	27	2	M090280	Aftermarket, shorter than OE
		4.0	8.3x11.5	4.0	102	211x292	102	1.9	26	2	M090534	Aftermarket, shorter than OE
		5.0	10x15	5.0	127	254x381	127	1.1	15	2	M120108	For off-hwy, shorter than OE
		5.0	10x15	5.0	127	254x381	127	1.2	16	2	M120365	Aftermarket
L10	300 to 375	3.0	11.0	4.0	76	279	102	1.3	18	1	M111029	OE replacement
		4.0	10.0	4.0	102	254	102	2.2	30	2	M100048	Aftermarket
		4.0	11.0	4.0	102	279	102	2.1	29	2	M110012	
		4.0	11.0	4.0	102	279	102	1.9	26	2	M110189	OE replacement
		4.0	11.0	5.0	102	279	127	1.1	15	2	M111028	Inlet dimension is OD
		4.0	10x15	4.0	102	254x381	102	1.6	22	2	M120100	Aftermarket, shorter than OE
		4.0	8.3x11.5	4.0	102	211x292	102	2.2	30	2	M090280	Aftermarket, shorter than OE
		4.0	8.3x11.5	4.0	102	211x292	102	2.0	28	2	M090534	Aftermarket, shorter than OE
		5.0	10x15	5.0	127	254x381	127	1.2	16	2	M120108	For off-hwy, shorter than OE
		5.0	10x15	5.0	127	254x381	127	1.3	17	2	M120365	Aftermarket
		5.0	10x15	5.0	127	254x381	127	1.3	18	2	M120448	OE replacement
		M11	400	3.0	11.0	4.0	76	279	102	1.9	26	1
4.0	11.0			4.0	102	279	102	2.8	38	2	M110189	OE replacement
4.0	11.0			5.0	102	279	127	1.6	22	2	M111028	Inlet dimension is OD
4.0	10x15			4.0	102	254x381	102	2.3	31	2	M120100	Aftermarket, shorter than OE

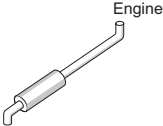
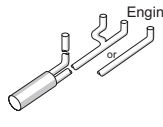
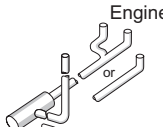
Engine Make & Exhaust System Configuration	Engine Model	H.P.	Muffler Dimensions inches			Muffler Dimensions mm			Backpressure inches of Hg / H ₂ O		Muffler Style & Part No.	Notes	
			Inlet	Body	Outlet	Inlet	Body	Outlet	Hg	H ₂ O			
	N14	330	4.0	8.3x11.5	4.0	102	211x292	102	2.9	40	2	M090534	Aftermarket, shorter than OE
			5.0	10x15	5.0	127	254x381	127	1.7	23	2	M120108	For off-hwy, shorter than OE
			5.0	10x15	5.0	127	254x381	127	1.8	24	2	M120365	Aftermarket
			5.0	10x15	5.0	127	254x381	127	1.9	25	2	M120448	OE replacement
	N14	350 to 460	3.0	11.0	4.0	76	279	102	2.7	37	1	M111029	OE replacement
			4.0	11.0	5.0	102	279	127	2.3	31	2	M111028	Inlet dimension is OD
			5.0	10x15	5.0	127	254x381	127	1.6	22	2	M120225	For off-hwy, shorter than OE
	N14	500 to 550	6.0	10x15	6.0	152	254x381	152	1.3	18	2	M122300	For off-hwy, shorter than OE
			5.0	10x15	5.0	127	254x381	127	2.8	38	2	M120225	For off-hwy, shorter than OE
	NTC	255 to 290	6.0	10x15	6.0	152	254x381	152	2.3	31	2	M122300	For off-hwy, shorter than OE
3.0			11.0	4.0	76	279	102	1.7	23	1	M111029	OE replacement	
Signature	300 to 350	500 to 565	4.0	10.0	4.0	102	254	102	2.8	37	2	M100048	Aftermarket
			4.0	11.0	4.0	102	279	102	2.7	36	2	M110012	
			4.0	11.0	4.0	102	279	102	2.4	33	2	M110189	OE replacement
	300 to 350	500 to 565	4.0	11.0	5.0	102	279	127	1.4	19	2	M111028	Inlet dimension is OD
			4.0	10x15	4.0	102	254x381	102	2.0	27	2	M120100	Aftermarket, shorter than OE
			4.0	8.3x11.5	4.0	102	211x292	102	2.7	37	2	M090280	Aftermarket, shorter than OE
	300 to 350	500 to 565	4.0	8.3x11.5	4.0	102	211x292	102	2.5	34	2	M090534	Aftermarket, shorter than OE
			5.0	10x15	5.0	127	254x381	127	1.5	20	2	M120108	For off-hwy, shorter than OE
			5.0	10x15	5.0	127	254x381	127	1.6	21	2	M120365	Aftermarket
	300 to 350	500 to 565	5.0	10x15	5.0	127	254x381	127	1.6	22	2	M120448	OE replacement
			3.0	11.0	4.0	76	279	102	2.8	38	1	M111029	OE replacement
			4.0	11.0	5.0	102	279	127	2.3	32	2	M111028	Inlet dimension is OD
	Signature	500 to 565	5.0	10x15	5.0	127	254x381	127	2.5	34	2	M120108	For off-hwy, shorter than OE
			5.0	10x15	5.0	127	254x381	127	2.6	36	2	M120365	Aftermarket
			5.0	10x15	5.0	127	254x381	127	2.7	37	2	M120448	OE replacement
Signature	600	5.0	10x15	5.0	127	254x381	127	2.8	38	2	M120225	For off-hwy, shorter than OE	
		6.0	10x15	6.0	152	254x381	152	2.3	32	2	M122300	For off-hwy, shorter than OE	
Signature	600	6.0	10x15	6.0	152	254x381	152	2.6	36	2	M122300	For off-hwy, shorter than OE	
		5.0	10x15	5.0	127	254x381	127	1.4	19	5	M120131	For off-hwy, shorter than OE	
	ISM	310 to 350	5.0	10x15	5.0	127	254x381	127	2.8	38	5	M120176	Aftermarket, shorter than OE
			5.0	10x15	5.0	127	254x381	127	2.8	38	5	M120189	Aftermarket, shorter than OE
			5.0	10x15	5.0	127	254x381	127	1.7	23	5	M120450	OE replacement
			5.0	10x15	5.0	127	254x381	127	1.7	23	5	M120450	OE replacement
	ISM	400 to 500	5.0	10x15	5.0	127	254x381	127	2.0	28	5	M120131	For off-hwy, shorter than OE
			5.0	10x15	5.0	127	254x381	127	2.4	32	5	M120450	OE replacement
	ISX	400 to 475	5.0	10x15	5.0	127	254x381	127	2.5	34	5	M120131	For off-hwy, shorter than OE
			5.0	10x15	5.0	127	254x381	127	2.9	40	5	M120450	OE replacement
	ISX	500	5.0	10x15	5.0	127	254x381	127	2.7	37	5	M120131	For off-hwy, shorter than OE
	M11	400	5.0	10x15	5.0	127	254x381	127	1.1	15	5	M120131	For off-hwy, shorter than OE
5.0			10x15	5.0	127	254x381	127	2.2	30	5	M120176	Aftermarket, shorter than OE	
5.0			10x15	5.0	127	254x381	127	2.2	30	5	M120189	Aftermarket, shorter than OE	
5.0			10x15	5.0	127	254x381	127	1.3	18	5	M120450	OE replacement	
N14	330 to 400	5.0	10x15	5.0	127	254x381	127	2.4	33	5	M120131	For off-hwy, shorter than OE	
		5.0	10x15	5.0	127	254x381	127	2.9	39	5	M120450	OE replacement	
N14	435 to 460	5.0	10x15	5.0	127	254x381	127	2.8	38	5	M120131	For off-hwy, shorter than OE	
NTC	400	5.0	10x15	5.0	127	254x381	127	2.9	40	5	M120131	For off-hwy, shorter than OE	
Signature	500	5.0	10x15	5.0	127	254x381	127	2.5	34	5	M120131	For off-hwy, shorter than OE	
		5.0	10x15	5.0	127	254x381	127	3.0	40	5	M120450	OE replacement	
Signature	565	5.0	10x15	5.0	127	254x381	127	2.8	38	5	M120131	For off-hwy, shorter than OE	
	6BT	230	4.0	10.0	4.0	102	254	102	2.0	28	4	M100052	
			4.0	11.0	4.0	102	279	102	1.7	23	4	M110112	
			4.0	11.0	4.0	102	279	102	1.7	23	4	M110148	
			4.0	11.0	4.0	102	279	102	1.7	23	4	M110311	Inlet dimension is OD
			4.0	11.0	4.0	102	279	102	1.5	20	4	M111025	Inlet & outlet dimension is OD
			4.0	10x15	4.0	102	254x381	102	2.0	27	4	M120367	Aftermarket, shorter than OE
			5.0	11.0	5.0	127	279	127	1.0	13	4	M110014	OE replacement
			5.0	10x15	5.0	127	254x381	127	1.0	14	4	M120366	OE replacement
			5.0	10x15	5.0	127	254x381	127	1.6	22	4	M120417	Aftermarket, shorter than OE
			6CT	250	4.0	10.0	4.0	102	254	102	2.8	38	4
4.0	11.0	4.0			102	279	102	2.3	32	4	M110112		
4.0	11.0	4.0			102	279	102	2.3	32	4	M110148		
4.0	11.0	4.0			102	279	102	2.3	32	4	M110311	Inlet dimension is OD	
4.0	11.0	4.0			102	279	102	2.1	28	4	M111025	Inlet & outlet dimension is OD	
4.0	10x15	4.0			102	254x381	102	2.7	37	4	M120367	Aftermarket, shorter than OE	

TRUCK ENGINE APPL.

Truck Engine Muffler Application



TRUCK ENGINE APPL.

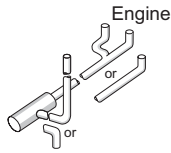

Engine Make & Exhaust System Configuration	Engine Model	Engine H.P.	Muffler Dimensions inches			Muffler Dimensions mm			Backpressure inches of Hg H ₂ O		Muffler Style & Part No.	Notes	
			Inlet	Body	Outlet	Inlet	Body	Outlet	Hg	H ₂ O			
6CT	300		5.0	11.0	5.0	127	279	127	1.3	18	4	M110014	OE replacement
			5.0	10x15	5.0	127	254x381	127	1.4	19	4	M120366	OE replacement
			5.0	10x15	5.0	127	254x381	127	2.2	31	4	M120417	Aftermarket, shorter than OE
			4.0	11.0	4.0	102	279	102	3.0	40	4	M111025	Inlet & outlet dimension is OD
			5.0	11.0	5.0	127	279	127	1.9	26	4	M110014	OE replacement
ISB	185 to 225		5.0	10x15	5.0	127	254x381	127	2.0	27	4	M120366	OE replacement
			4.0	10.0	4.0	102	254	102	1.8	24	4	M100052	
			4.0	11.0	4.0	102	279	102	1.5	20	4	M110112	
			4.0	11.0	4.0	102	279	102	1.5	20	4	M110148	
			4.0	11.0	4.0	102	279	102	1.5	20	4	M110311	Inlet dimension is OD
			4.0	11.0	4.0	102	279	102	1.3	17	4	M111025	Inlet & outlet dimension is OD
			4.0	10x15	4.0	102	254x381	102	1.7	23	4	M120367	Aftermarket, shorter than OE
			5.0	11.0	5.0	127	279	127	0.8	11	4	M110014	OE replacement
			5.0	10x15	5.0	127	254x381	127	0.9	12	4	M120366	OE replacement
ISB	240 to 300		5.0	10x15	5.0	127	254x381	127	1.4	19	4	M120417	Aftermarket, shorter than OE
			4.0	10.0	4.0	102	254	102	2.6	35	4	M100052	
			4.0	11.0	4.0	102	279	102	2.1	29	4	M110112	
			4.0	11.0	4.0	102	279	102	2.1	29	4	M110148	
			4.0	11.0	4.0	102	279	102	2.1	29	4	M110311	Inlet dimension is OD
			4.0	11.0	4.0	102	279	102	1.9	26	4	M111025	Inlet & outlet dimension is OD
			4.0	10x15	4.0	102	254x381	102	2.5	34	4	M120367	Aftermarket, shorter than OE
			5.0	11.0	5.0	127	279	127	1.2	17	4	M110014	OE replacement
			5.0	10x15	5.0	127	254x381	127	1.3	17	4	M120366	OE replacement
ISC	225 to 240		5.0	10x15	5.0	127	254x381	127	2.1	28	4	M120417	Aftermarket, shorter than OE
			4.0	10.0	4.0	102	254	102	2.7	37	4	M100052	
			4.0	11.0	4.0	102	279	102	2.3	31	4	M110112	
			4.0	11.0	4.0	102	279	102	2.3	31	4	M110148	
			4.0	11.0	4.0	102	279	102	2.3	31	4	M110311	Inlet dimension is OD
			4.0	11.0	4.0	102	279	102	2.0	27	4	M111025	Inlet & outlet dimension is OD
			4.0	10x15	4.0	102	254x381	102	2.7	36	4	M120367	Aftermarket, shorter than OE
			5.0	11.0	5.0	127	279	127	1.3	18	4	M110014	OE replacement
			5.0	10x15	5.0	127	254x381	127	1.4	18	4	M120366	OE replacement
ISC	260 to 300		5.0	10x15	5.0	127	254x381	127	2.2	30	4	M120417	Aftermarket, shorter than OE
			4.0	11.0	4.0	102	279	102	2.5	34	4	M110112	
			4.0	11.0	4.0	102	279	102	2.5	34	4	M110148	
			4.0	11.0	4.0	102	279	102	2.5	34	4	M110311	Inlet dimension is OD
			4.0	11.0	4.0	102	279	102	2.2	30	4	M111025	Inlet & outlet dimension is OD
			4.0	10x15	4.0	102	254x381	102	2.9	40	4	M120367	Aftermarket, shorter than OE
			5.0	11.0	5.0	127	279	127	1.4	19	4	M110014	OE replacement
			5.0	10x15	5.0	127	254x381	127	1.5	20	4	M120366	OE replacement
			5.0	10x15	5.0	127	254x381	127	2.4	33	4	M120417	Aftermarket, shorter than OE
ISC	315 to 350		4.0	11.0	4.0	102	279	102	2.9	40	4	M110112	
			4.0	11.0	4.0	102	279	102	2.9	40	4	M110148	
			4.0	11.0	4.0	102	279	102	2.9	40	4	M110311	Inlet dimension is OD
			4.0	11.0	4.0	102	279	102	2.6	35	4	M111025	Inlet & outlet dimension is OD
			5.0	11.0	5.0	127	279	127	1.7	23	4	M110014	OE replacement
			5.0	10x15	5.0	127	254x381	127	1.8	24	4	M120366	OE replacement
			5.0	10x15	5.0	127	254x381	127	2.8	38	4	M120417	Aftermarket, shorter than OE
			4.0	10.0	4.0	102	254	102	2.3	31	4	M100052	
L10	260 to 300		4.0	11.0	4.0	102	279	102	1.9	26	4	M110112	
			4.0	11.0	4.0	102	279	102	1.9	26	4	M110148	
			4.0	11.0	4.0	102	279	102	1.9	26	4	M110311	Inlet dimension is OD
			4.0	11.0	4.0	102	279	102	1.7	22	4	M111025	Inlet & outlet dimension is OD
			4.0	10x15	4.0	102	254x381	102	2.2	30	4	M120367	Aftermarket, shorter than OE
			5.0	11.0	5.0	127	279	127	1.1	15	4	M110014	OE replacement
			5.0	10x15	5.0	127	254x381	127	1.1	15	4	M120366	OE replacement
			5.0	10x15	5.0	127	254x381	127	1.8	25	4	M120417	Aftermarket, shorter than OE
			4.0	10.0	4.0	102	254	102	2.8	39	4	M100052	
NTC	255 to 290		4.0	11.0	4.0	102	279	102	2.3	32	4	M110112	
			4.0	11.0	4.0	102	279	102	2.3	32	4	M110148	
			4.0	11.0	4.0	102	279	102	2.3	32	4	M110311	Inlet dimension is OD
			4.0	11.0	4.0	102	279	102	2.1	28	4	M111025	Inlet & outlet dimension is OD
			4.0	10x15	4.0	102	254x381	102	2.7	37	4	M120367	Aftermarket, shorter than OE
			5.0	11.0	5.0	127	279	127	1.3	18	4	M110014	OE replacement
			5.0	10x15	5.0	127	254x381	127	1.4	19	4	M120366	OE replacement
			5.0	10x15	5.0	127	254x381	127	2.3	31	4	M120417	Aftermarket, shorter than OE
			4.0	10.0	4.0	102	254	102	2.8	39	4	M100052	
NTC	300 to 350		5.0	11.0	5.0	127	279	127	2.5	34	4	M110014	OE replacement
			5.0	10x15	5.0	127	254x381	127	2.6	36	4	M120366	OE replacement

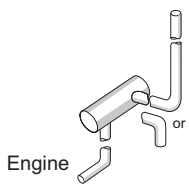
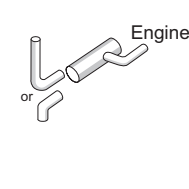
Engine Make & Exhaust System Configuration	Engine Model	H.P.	Muffler Dimensions						Backpressure		Muffler Style & Part No.	Notes	
			inches			mm			inches of Hg	H ₂ O			
			Inlet	Body	Outlet	Inlet	Body	Outlet					
	6BT	230	4.0	10.0	4.0	102	254	102	2.1	28	6	M100572	
			4.0	11.0	4.0	102	279	102	1.6	22	6	M111026	Outlet dimension is OD
			5.0	10x15	5.0	127	254x381	127	1.1	14	4	M120418	For off-hwy, shorter than OE
	6CT	250	4.0	10.0	4.0	102	254	102	2.9	39	6	M100572	
			4.0	11.0	4.0	102	279	102	2.2	31	6	M111026	Outlet dimension is OD
			5.0	10x15	5.0	127	254x381	127	1.5	20	6	M120418	For off-hwy, shorter than OE
	6CT	300	5.0	10x15	5.0	127	254x381	127	2.1	29	6	M120418	For off-hwy, shorter than OE
	ISB	185 to 225	4.0	10.0	4.0	102	254	102	1.8	25	6	M100572	
			4.0	11.0	4.0	102	279	102	1.4	19	6	M111026	Outlet dimension is OD
			5.0	10x15	5.0	127	254x381	127	0.9	12	6	M120418	For off-hwy, shorter than OE
	ISB	240 to 300	4.0	10.0	4.0	102	254	102	2.7	36	6	M100572	
			4.0	11.0	4.0	102	279	102	2.1	28	6	M111026	Outlet dimension is OD
5.0			10x15	5.0	127	254x381	127	1.3	18	6	M120418	For off-hwy, shorter than OE	
ISC	225 to 240	4.0	10.0	4.0	102	254	102	2.8	38	6	M100572		
		4.0	11.0	4.0	102	279	102	2.2	30	6	M111026	Outlet dimension is OD	
		5.0	10x15	5.0	127	254x381	127	1.4	19	6	M120418	For off-hwy, shorter than OE	
ISC	260 to 300	4.0	10.0	4.0	102	254	102	2.9	39	6	M100572		
		4.0	11.0	4.0	102	279	102	2.2	30	6	M111026	Outlet dimension is OD	
		5.0	10x15	5.0	127	254x381	127	1.4	20	6	M120418	For off-hwy, shorter than OE	
ISC	315 to 350	4.0	11.0	4.0	102	279	102	2.8	38	6	M111026	Outlet dimension is OD	
		5.0	10x15	5.0	127	254x381	127	1.8	25	6	M120418	For off-hwy, shorter than OE	
		4.0	10.0	4.0	102	254	102	2.3	32	6	M100572		
L10	260 to 300	4.0	11.0	4.0	102	279	102	1.8	25	6	M111026	Outlet dimension is OD	
		5.0	10x15	5.0	127	254x381	127	1.2	16	6	M120418	For off-hwy, shorter than OE	
		4.0	10.0	4.0	102	254	102	2.9	40	6	M100572		
NTC	255 to 290	4.0	11.0	4.0	102	279	102	2.3	31	6	M111026	Outlet dimension is OD	
		5.0	10x15	5.0	127	254x381	127	1.5	20	6	M120418	For off-hwy, shorter than OE	
		5.0	10x15	5.0	127	254x381	127	2.7	37	6	M120418	For off-hwy, shorter than OE	
NTC	300 to 350	5.0	10x15	5.0	127	254x381	127	2.7	37	6	M120418	For off-hwy, shorter than OE	
	6BT	230	4.0	11.0	4.0	102	279	102	2.2	30	3	M110479	
			4.0	11.0	4.0	102	279	102	2.0	28	3	M110674	Band clamp on inlet
			4.0	11.0		102	279		2.0	27	3	M111024	Outlet has down spout
			5.0	10x15	5.0	127	254x381	127	1.3	18	3	M120235	OE replacement
	6CT	250	4.0	11.0	4.0	102	279	102	2.8	39	3	M110674	Band clamp on inlet
			4.0	11.0		102	279		2.8	37	3	M111024	Outlet has down spout
			5.0	10x15	5.0	127	254x381	127	1.8	25	3	M120235	OE replacement
	6CT	300	5.0	10x15	5.0	127	254x381	127	2.6	36	3	M120235	OE replacement
	ISB	185 to 225	4.0	11.0	4.0	102	279	102	1.9	26	3	M110479	
			4.0	11.0	4.0	102	279	102	1.8	24	3	M110674	Band clamp on inlet
			4.0	11.0		102	279		1.7	23	3	M111024	Outlet has down spout
			5.0	10x15	5.0	127	254x381	127	1.1	15	3	M120235	OE replacement
ISB	240 to 275	4.0	11.0	4.0	102	279	102	2.8	38	3	M110479		
		4.0	11.0	4.0	102	279	102	2.5	35	3	M110674	Band clamp on inlet	
		4.0	11.0		102	279		2.5	34	3	M111024	Outlet has down spout	
		5.0	10x15	5.0	127	254x381	127	1.6	22	3	M120235	OE replacement	
ISB	300	4.0	11.0	4.0	102	279	102	2.8	39	3	M110479		
		4.0	11.0	4.0	102	279	102	2.6	36	3	M110674	Band clamp on inlet	
		4.0	11.0		102	279		2.5	34	3	M111024	Outlet has down spout	
		5.0	10x15	5.0	127	254x381	127	1.7	23	3	M120235	OE replacement	
ISC	225	4.0	11.0	4.0	102	279	102	2.8	38	3	M110479		
		4.0	11.0	4.0	102	279	102	2.5	35	3	M110674	Band clamp on inlet	
		4.0	11.0		102	279		2.5	34	3	M111024	Outlet has down spout	
		5.0	10x15	5.0	127	254x381	127	1.6	22	3	M120235	OE replacement	
ISC	240	4.0	11.0	4.0	102	279	102	2.7	37	3	M110674	Band clamp on inlet	
		4.0	11.0		102	279		2.7	36	3	M111024	Outlet has down spout	
		5.0	10x15	5.0	127	254x381	127	1.8	24	3	M120235	OE replacement	
ISC	260	4.0	11.0		102	279		2.9	40	3	M111024	Outlet has down spout	
		5.0	10x15	5.0	127	254x381	127	1.9	26	3	M120235	OE replacement	
ISC	285	4.0	11.0	4.0	102	279	102	3.0	40	3	M110479		
		4.0	11.0	4.0	102	279	102	2.7	37	3	M110674	Band clamp on inlet	
		4.0	11.0		102	279		2.7	36	3	M111024	Outlet has down spout	
		5.0	10x15	5.0	127	254x381	127	1.8	24	3	M120235	OE replacement	
ISC	300	4.0	11.0	4.0	102	279	102	2.8	38	3	M110674	Band clamp on inlet	
		4.0	11.0		102	279		2.7	37	3	M111024	Outlet has down spout	
		5.0	10x15	5.0	127	254x381	127	1.8	24	3	M120235	OE replacement	

Truck Engine Muffler Application

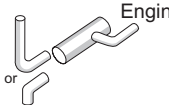

TRUCK ENGINE APPL.

Engine Make & Exhaust System Configuration	Engine Model	Engine H.P.	Muffler Dimensions						Backpressure		Muffler Style & Part No.	Notes	
			inches			mm			inches of Hg	H ₂ O			
	ISC	315	5.0	10x15	5.0	127	254x381	127	2.0	28	3	M120235	OE replacement
	ISC	330	5.0	10x15	5.0	127	254x381	127	2.1	29	3	M120235	OE replacement
	ISC	350	5.0	10x15	5.0	127	254x381	127	2.3	31	3	M120235	OE replacement
	L10	260 to 300	4.0	11.0	4.0	102	279	102	2.5	34	3	M110479	
			4.0	11.0	4.0	102	279	102	2.3	31	3	M110674	Band clamp on inlet
			4.0	11.0		102	279		2.2	30	3	M111024	Outlet has down spout
			5.0	10x15	5.0	127	254x381	127	1.5	20	3	M120235	OE replacement
	NTC	255 to 290	4.0	11.0	4.0	102	279	102	2.3	31	3	M110479	
			4.0	11.0	4.0	102	279	102	2.1	28	3	M110674	Band clamp on inlet
			4.0	11.0		102	279		2.0	27	3	M111024	Outlet has down spout
			5.0	10x15	5.0	127	254x381	127	1.3	18	3	M120235	OE replacement
	NTC	335	5.0	10x15	5.0	127	254x381	127	2.8	38	3	M120235	OE replacement

Detroit Diesel

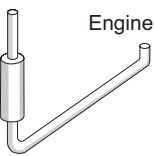

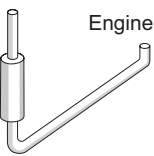
	8V-92T	430	4.0	8.5	4.0	102	216	102	2.4	33	1	M085171	
			5.0	9.0	5.0	127	229	127	2.9	40	1	M090074	
			5.0	9.0	5.0	127	229	127	1.6	21	1	M090535	Low backpressure, off-hwy
			5.0	10.0	5.0	127	254	127	1.6	21	1	M100463	Low backpressure, off-hwy
			5.0	10.0	5.0	127	254	127	2.6	36	1	M100944	OE replacement for higher HP
			5.0	10.0	5.0	127	254	127	2.9	40	1	M101158	Silent Partner Stainless
			5.0	10.0	5.0	127	254	127	2.9	40	1	M101181	Silent Partner Aluminized
	8V-92TT	365	4.0	8.5	4.0	102	216	102	2.9	39	1	M085171	
			5.0	9.0	5.0	127	229	127	1.9	25	1	M090535	Low backpressure, off-hwy
			5.0	10.0	5.0	127	254	127	1.9	25	1	M100463	Low backpressure, off-hwy
	8V-92TTA	445	4.0	8.5	4.0	102	216	102	2.7	36	1	M085171	
			5.0	9.0	5.0	127	229	127	1.7	23	1	M090535	Low backpressure, off-hwy
			5.0	10.0	5.0	127	254	127	1.7	23	1	M100463	Low backpressure, off-hwy
			5.0	10.0	5.0	127	254	127	2.9	39	1	M100944	OE replacement for higher HP
			5.0	11.0	5.0	127	279	127	2.9	39	1	M110849	
Series 60 (12.7 Ltr)	350 to 400	4.0	8.5	4.0	102	216	102	1.9	26	1	M085171		
		4.0	9.0	5.0	102	229	127	2.7	37	1	M090781		
		5.0	9.0	5.0	127	229	127	2.3	31	1	M090074		
		5.0	9.0	5.0	127	229	127	1.2	17	1	M090535	Low backpressure, off-hwy	
		5.0	10.0	5.0	127	254	127	1.2	17	1	M100463	Low backpressure, off-hwy	
		5.0	10.0	5.0	127	254	127	2.5	34	1	M100465	Best value, most popular	
		5.0	10.0	5.0	127	254	127	2.6	35	1	M100580	OE replacement	
		5.0	10.0	5.0	127	254	127	2.8	38	1	M100807	60" (1524mm) Long Body	
		5.0	10.0	5.0	127	254	127	2.1	28	1	M100944	OE replacement for higher HP	
		5.0	10.0	5.0	127	254	127	2.5	34	1	M101158	Silent Partner Stainless	
		5.0	10.0	5.0	127	254	127	2.5	34	1	M101181	Silent Partner Aluminized	
		5.0	10.0	5.0	127	254	127	2.6	35	1	M101263	Freightliner only	
		5.0	11.0	5.0	127	279	127	2.1	28	1	M110849		
Series 60 (12.7 Ltr)	430	4.0	8.5	4.0	102	216	102	2.1	28	1	M085171		
		5.0	9.0	5.0	127	229	127	2.5	34	1	M090074		
		5.0	9.0	5.0	127	229	127	1.3	18	1	M090535	Low backpressure, off-hwy	
		5.0	10.0	5.0	127	254	127	1.3	18	1	M100463	Low backpressure, off-hwy	
		5.0	10.0	5.0	127	254	127	2.7	37	1	M100465	Best value, most popular	
		5.0	10.0	5.0	127	254	127	2.8	39	1	M100580	OE replacement	
		5.0	10.0	5.0	127	254	127	2.3	31	1	M100944	OE replacement for higher HP	
		5.0	10.0	5.0	127	254	127	2.7	37	1	M101158	Silent Partner Stainless	
		5.0	10.0	5.0	127	254	127	2.7	37	1	M101181	Silent Partner Aluminized	
		5.0	10.0	5.0	127	254	127	2.8	39	1	M101263	Freightliner only	
		5.0	11.0	5.0	127	279	127	2.2	31	1	M110849		
Series 60 (12.7 Ltr)	470 to 500	4.0	8.5	4.0	102	216	102	2.5	33	1	M085171		
		5.0	9.0	5.0	127	229	127	3.0	40	1	M090074		
		5.0	9.0	5.0	127	229	127	1.6	21	1	M090535	Low backpressure, off-hwy	
		5.0	10.0	5.0	127	254	127	1.6	21	1	M100463	Low backpressure, off-hwy	
		5.0	10.0	5.0	127	254	127	2.7	36	1	M100944	OE replacement for higher HP	
		5.0	11.0	5.0	127	279	127	2.6	36	1	M110849		
Series 60 (14 Ltr)	550 to 575	5.0	9.0	5.0	127	229	127	2.0	27	1	M090535	Low backpressure, off-hwy	
		5.0	10.0	5.0	127	254	127	2.0	27	1	M100463	Low backpressure, off-hwy	
Series 60 (12.7 Ltr)	Cruise Power 330/350 & 370/430	4.0	8.5	4.0	102	216	102	2.1	28	1	M085171		
		5.0	9.0	5.0	127	229	127	2.5	34	1	M090074		
		5.0	9.0	5.0	127	229	127	1.3	18	1	M090535	Low backpressure, off-hwy	
		5.0	10.0	5.0	127	254	127	1.3	18	1	M100463	Low backpressure, off-hwy	
		5.0	10.0	5.0	127	254	127	2.7	37	1	M100465	Best value, most popular	

Engine Make & Exhaust System Configuration	Engine Model	H.P.	Muffler Dimensions inches			Muffler Dimensions mm			Backpressure inches of Hg H ₂ O		Muffler Style & Part No.	Notes		
			Inlet	Body	Outlet	Inlet	Body	Outlet	Hg	H ₂ O				
Series 60 (12.7 Ltr)	Cruise Power 430/470	5.0	10.0	5.0	127	254	127	2.8	39	1	M100580	OE replacement		
			10.0	5.0	127	254	127	2.3	31	1	M100944	OE replacement for higher HP		
			10.0	5.0	127	254	127	2.7	37	1	M101158	Silent Partner Stainless		
			10.0	5.0	127	254	127	2.7	37	1	M101181	Silent Partner Aluminized		
			10.0	5.0	127	254	127	2.8	39	1	M101263	Freightliner only		
		4.0	8.5	4.0	10.0	4.0	102	216	102	2.2	30	1	M085171	
					9.0	5.0	127	229	127	2.6	36	1	M090074	
					9.0	5.0	127	229	127	1.4	19	1	M090535	Low backpressure, off-hwy
					10.0	5.0	127	254	127	1.4	19	1	M100463	Low backpressure, off-hwy
					10.0	5.0	127	254	127	2.8	38	1	M100465	Best value, most popular
					10.0	5.0	127	254	127	2.9	40	1	M100580	OE replacement
					10.0	5.0	127	254	127	2.4	32	1	M100944	OE replacement for higher HP
					10.0	5.0	127	254	127	2.9	39	1	M101158	Silent Partner Stainless
					10.0	5.0	127	254	127	2.9	39	1	M101181	Silent Partner Aluminized
					10.0	5.0	127	254	127	2.9	40	1	M101263	Freightliner only
Series 60 (12.7 Ltr)	Cruise Power 470/500	4.0	8.5	4.0	102	216	102	2.5	33	1	M085171			
			9.0	5.0	127	229	127	3.0	40	1	M090074			
			9.0	5.0	127	229	127	1.6	21	1	M090535	Low backpressure, off-hwy		
			10.0	5.0	127	254	127	1.6	21	1	M100463	Low backpressure, off-hwy		
			10.0	5.0	127	254	127	2.7	36	1	M100944	OE replacement for higher HP		
8V-92T	430	4.0	9.0	4.0	102	229	102	2.6	35	1	M090544			
			10.0	4.0	102	254	102	2.8	37	1	M100466			
			11.0	5.0	127	279	127	1.8	25	1	M110849			
		8V-92TA	435	4.0	9.0	4.0	102	229	102	2.1	28	1	M090544	
					10.0	4.0	102	254	102	2.2	30	1	M100466	
					10.0	5.0	127	254	127	2.7	37	1	M101159	Silent Partner Stainless
					10.0	5.0	127	254	127	2.7	37	1	M101182	Silent Partner Aluminized
					11.0	5.0	127	279	127	1.5	20	1	M110849	
		8V-92TT	365	4.0	9.0	4.0	102	229	102	1.7	23	1	M090544	
					10.0	4.0	102	254	102	1.8	25	1	M100466	
					10.0	5.0	127	254	127	2.2	30	1	M100582	OE replacement
					10.0	5.0	102	254	127	2.9	39	1	M100695	
					10.0	5.0	127	254	127	2.2	30	1	M101159	Silent Partner Stainless
					10.0	5.0	127	254	127	2.2	30	1	M101182	Silent Partner Aluminized
		8V-92TTA	445	4.0	9.0	4.0	102	229	102	1.6	22	1	M090544	
10.0	4.0				102	254	102	1.7	23	1	M100466			
10.0	5.0				127	254	127	2.1	28	1	M100582	OE replacement		
10.0	5.0				102	254	127	2.7	36	1	M100695			
10.0	5.0				127	254	127	2.1	28	1	M101159	Silent Partner Stainless		
10.0	5.0				127	254	127	2.1	28	1	M101182	Silent Partner Aluminized		
Series 60 (12.7 Ltr)	330 to 400	4.0	9.0	4.0	102	229	102	1.1	15	1	M090544			
			10.3	4.0	102	262	102	2.3	31	1	M100464	Wrapped muffler		
			10.0	4.0	102	254	102	1.2	16	1	M100466			
			10.0	5.0	102	254	127	1.9	26	1	M100695			
			10.0	5.0	127	254	127	1.5	20	1	M100582	OE replacement		
			10.0	5.0	127	254	127	1.5	20	1	M101159	Silent Partner Stainless		
			10.0	5.0	127	254	127	1.5	20	1	M101182	Silent Partner Aluminized		
Series 60 (12.7 Ltr)	430	4.0	9.0	4.0	102	229	102	1.2	17	1	M090544			
			10.3	4.0	102	262	102	2.5	34	1	M100464	Wrapped muffler		
			10.0	4.0	102	254	102	1.3	18	1	M100466			
			10.0	5.0	102	254	127	2.1	28	1	M100695			
			10.0	5.0	127	254	127	1.6	22	1	M100582	OE replacement		
			10.0	5.0	127	254	127	1.6	22	1	M101159	Silent Partner Stainless		
			10.0	5.0	127	254	127	1.6	22	1	M101182	Silent Partner Aluminized		
Series 60 (12.7 Ltr)	470 to 500	4.0	9.0	4.0	102	229	102	1.5	20	1	M090544			
			10.3	4.0	102	262	102	2.9	39	1	M100464	Wrapped muffler		
			10.0	4.0	102	254	102	1.5	21	1	M100466			
			10.0	5.0	102	254	127	2.5	33	1	M100695			
			10.0	5.0	127	254	127	1.9	26	1	M100582	OE replacement		
			10.0	5.0	127	254	127	1.9	26	1	M101159	Silent Partner Stainless		
			10.0	5.0	127	254	127	1.9	26	1	M101182	Silent Partner Aluminized		

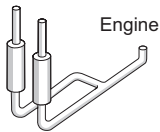

Truck Engine Muffler Application

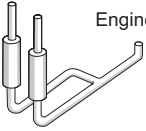
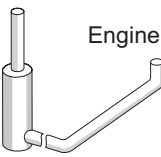
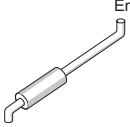

TRUCK ENGINE APPL.

Engine Make & Exhaust System Configuration	Engine Model	H.P.	Muffler Dimensions						Backpressure		Muffler Style & Part No.	Notes	
			inches			mm			inches of Hg	H ₂ O			
 Engine	Series 60 (14 Ltr)	550 to 575	4.0	9.0	4.0	102	229	102	1.8	25	1	M090544	
			4.0	10.0	4.0	102	254	102	1.9	26	1	M100466	
			5.0	10.0	5.0	127	254	127	2.4	32	1	M100582	OE replacement
			5.0	10.0	5.0	127	254	127	2.4	32	1	M101159	Silent Partner Stainless
			5.0	10.0	5.0	127	254	127	2.4	32	1	M101182	Silent Partner Aluminized
	5.0	11.0	5.0	127	279	127	1.3	17	1	M110849			
	Series 60 (12.7 Ltr)	Cruise Power 330/350 & 370/430	4.0	9.0	4.0	102	229	102	1.2	17	1	M090544	
			4.0	10.3	4.0	102	262	102	2.5	34	1	M100464	Wrapped muffler
			4.0	10.0	4.0	102	254	102	1.3	18	1	M100466	
			4.0	10.0	5.0	102	254	127	2.1	28	1	M100695	
			5.0	10.0	5.0	127	254	127	1.6	22	1	M100582	OE replacement
			5.0	10.0	5.0	127	254	127	1.6	22	1	M101159	Silent Partner Stainless
			5.0	10.0	5.0	127	254	127	1.6	22	1	M101182	Silent Partner Aluminized
			5.0	11.0	5.0	127	279	127	0.9	12	1	M110849	
	Series 60 (12.7 Ltr)	Cruise Power 430/470	4.0	9.0	4.0	102	229	102	1.3	18	1	M090544	
4.0			10.3	4.0	102	262	102	2.6	35	1	M100464	Wrapped muffler	
4.0			10.0	4.0	102	254	102	1.4	19	1	M100466		
4.0			10.0	5.0	102	254	127	2.2	30	1	M100695		
5.0			10.0	5.0	127	254	127	1.7	23	1	M100582	OE replacement	
5.0			10.0	5.0	127	254	127	1.7	23	1	M101159	Silent Partner Stainless	
5.0			10.0	5.0	127	254	127	1.7	23	1	M101182	Silent Partner Aluminized	
5.0			11.0	5.0	127	279	127	0.9	12	1	M110849		
Series 60 (12.7 Ltr)	Cruise Power 470/500	4.0	9.0	4.0	102	229	102	1.5	20	1	M090544		
		4.0	10.3	4.0	102	262	102	2.9	39	1	M100464	Wrapped muffler	
		4.0	10.0	4.0	102	254	102	1.5	21	1	M100466		
		4.0	10.0	5.0	102	254	127	2.5	33	1	M100695		
		5.0	10.0	5.0	127	254	127	1.9	26	1	M100582	OE replacement	
		5.0	10.0	5.0	127	254	127	1.9	26	1	M101159	Silent Partner Stainless	
		5.0	10.0	5.0	127	254	127	1.9	26	1	M101182	Silent Partner Aluminized	
		5.0	11.0	5.0	127	279	127	1.0	14	1	M110849		
 Engine	8.2T	205	4.0	9.0	5.0	102	229	127	1.0	13	3	M090823	
			4.0	10.0	4.0	102	254	102	2.8	39	3	M100146	
			4.0	11.8	5.0	102	300	127	1.0	14	3	M120598	
			5.0	10.0	5.0	127	254	127	0.9	13	3	M100213	
	Series 50 (8.7 Ltr)	250 to 275	4.0	9.0	5.0	102	229	127	1.8	25	3	M090823	
			4.0	11.8	5.0	102	300	127	1.9	26	3	M120598	
			5.0	10.0	5.0	127	254	127	1.7	23	3	M100213	
	Series 50 (8.7 Ltr)	300 to 350	4.0	9.0	5.0	102	229	127	2.3	32	3	M090823	
			4.0	11.8	5.0	102	300	127	2.4	33	3	M120598	
			5.0	10.0	5.0	127	254	127	2.2	29	3	M100213	
	Series 60	330	5.0	10.0	5.0	127	254	127	2.9	40	3	M100213	
	Series 60 (11.1 Ltr)	350 to 365	4.0	9.0	5.0	102	229	127	2.2	30	3	M090823	
			4.0	11.8	5.0	102	300	127	2.4	32	3	M120598	
			5.0	10.0	5.0	127	254	127	2.1	28	3	M100213	
	Series 40E (7.6 LTA)	175 to 190	4.0	9.0	5.0	102	229	127	1.5	21	3	M090823	
			4.0	11.8	5.0	102	300	127	1.6	22	3	M120598	
			5.0	10.0	5.0	127	254	127	1.4	19	3	M100213	
	Series 40E (7.6 LTA)	210 to 250	4.0	9.0	5.0	102	229	127	1.8	24	3	M090823	
			4.0	11.8	5.0	102	300	127	1.9	25	3	M120598	
			5.0	10.0	5.0	127	254	127	1.6	22	3	M100213	
	Series 40E (8.7 LTA)	250 to 330	4.0	9.0	5.0	102	229	127	1.8	24	3	M090823	
5.0			10.0	5.0	127	254	127	1.7	23	3	M100213		
4.0			11.8	5.0	102	300	127	1.9	26	3	M120598		
 Engine	6-71T	275	5.0	10x15	5.0	127	254x381	127	2.2	30	2	M120225	For off-hwy, shorter than OE
			6.0	10x15	6.0	152	254x381	152	1.8	25	2	M122300	For off-hwy, shorter than OE
	6V-92T	320	5.0	10x15	5.0	127	254x381	127	2.2	30	2	M120225	For off-hwy, shorter than OE
			6.0	10x15	6.0	152	254x381	152	1.8	25	2	M122300	For off-hwy, shorter than OE
	6V-92TA	350	6.0	10x15	6.0	152	254x381	152	2.5	34	2	M122300	For off-hwy, shorter than OE
	6V-92TA	335	6.0	10x15	6.0	152	254x381	152	2.5	34	2	M122300	For off-hwy, shorter than OE
	6V-92TT	270	5.0	10x15	5.0	127	254x381	127	2.1	29	2	M120225	For off-hwy, shorter than OE
			6.0	10x15	6.0	152	254x381	152	1.8	24	2	M122300	For off-hwy, shorter than OE
	6V-92TTA	270	5.0	10x15	5.0	127	254x381	127	2.2	30	2	M120225	For off-hwy, shorter than OE
			6.0	10x15	6.0	152	254x381	152	1.8	25	2	M122300	For off-hwy, shorter than OE
	8.2T	205	3.0	11.0	4.0	76	279	102	1.0	14	1	M111029	OE replacement

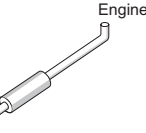
Engine Make & Exhaust System Configuration	Engine Model	H.P.	Muffler Dimensions inches			Muffler Dimensions mm			Backpressure inches of Hg H ₂ O		Muffler Style & Part No.	Notes			
			Inlet	Body	Outlet	Inlet	Body	Outlet	Hg	H ₂ O					
			3.5	8.3x11.5	3.5	89	211x292	89	2.9	39	2	M090158			
			3.5	8.5x11.8	3.5	89	216x300	89	2.9	39	2	M090210	Wrapped muffler		
			4.0	10.0	4.0	102	254	102	1.7	24	2	M100048	Aftermarket		
			4.0	11.0	4.0	102	279	102	1.7	23	2	M110012			
			4.0	11.0	4.0	102	279	102	1.5	21	2	M110189	OE replacement		
			4.0	11.0	5.0	102	279	127	0.9	12	2	M111028	Inlet dimension is OD		
			4.0	8.3x11.5	3.5	102	211x292	89	2.8	38	2	M090538			
			4.0	8.3x11.5	4.0	102	211x292	102	1.7	23	2	M090280	Aftermarket, shorter than OE		
			4.0	8.3x11.5	4.0	102	211x292	102	1.6	22	2	M090534	Aftermarket, shorter than OE		
			4.0	10x15	4.0	102	254x381	102	1.3	17	2	M120100	Aftermarket, shorter than OE		
			4.0	10.3x15.3	4.0	102	261x389	102	2.6	35	2	M120197	Wrapped muffler, OE		
			5.0	10x15	5.0	127	254x381	127	0.9	13	2	M120108	For off-hwy, shorter than OE		
			5.0	10x15	5.0	127	254x381	127	0.6	8	2	M120225	For off-hwy, shorter than OE		
			5.0	10x15	5.0	127	254x381	127	1.0	13	2	M120365	Aftermarket		
			5.0	10x15	5.0	127	254x381	127	1.0	14	2	M120448	OE replacement		
			8V-71T	335	5.0	10x15	5.0	127	254x381	127	2.4	33	2	M120225	For off-hwy, shorter than OE
					6.0	10x15	6.0	152	254x381	152	2.0	27	2	M122300	For off-hwy, shorter than OE
			8V-71TA	370	6.0	10x15	6.0	152	254x381	152	2.6	35	2	M122300	For off-hwy, shorter than OE
8V-71TT	305	6.0	10x15	6.0	152	254x381	152	2.6	35	2	M122300	For off-hwy, shorter than OE			
8V-71TTA	305	5.0	10x15	5.0	127	254x381	127	2.2	30	2	M120225	For off-hwy, shorter than OE			
		6.0	10x15	6.0	152	254x381	152	1.8	25	2	M122300	For off-hwy, shorter than OE			
8V-92TT	365	6.0	10x15	6.0	152	254x381	152	2.8	38	2	M122300	For off-hwy, shorter than OE			
8V-92TTA	445	6.0	10x15	6.0	152	254x381	152	2.6	35	2	M122300	For off-hwy, shorter than OE			
Series 60 (11.1 Ltr)	315 to 365	3.0	11.0	4.0	76	279	102	2.4	32	1	M111029	OE replacement			
		4.0	11.0	5.0	102	279	127	2.0	27	2	M111028	Inlet dimension is OD			
		4.0	10x15	4.0	102	254x381	102	2.9	39	2	M120100	Aftermarket, shorter than OE			
		5.0	10x15	5.0	127	254x381	127	2.1	29	2	M120108	For off-hwy, shorter than OE			
		5.0	10x15	5.0	127	254x381	127	1.4	19	2	M120225	For off-hwy, shorter than OE			
		5.0	10x15	5.0	127	254x381	127	2.2	30	2	M120365	Aftermarket			
		5.0	10x15	5.0	127	254x381	127	2.3	31	2	M120448	OE replacement			
		6.0	10x15	6.0	152	254x381	152	1.1	16	2	M122300	For off-hwy, shorter than OE			
Series 50 (8.7 Ltr)	250 to 275	3.0	11.0	4.0	76	279	102	2.2	30	1	M111029	OE replacement			
		4.0	11.0	5.0	102	279	127	1.9	26	2	M111028	Inlet dimension is OD			
		4.0	10x15	4.0	102	254x381	102	2.7	37	2	M120100	Aftermarket, shorter than OE			
		5.0	10x15	5.0	127	254x381	127	2.0	27	2	M120108	For off-hwy, shorter than OE			
		5.0	10x15	5.0	127	254x381	127	1.3	18	2	M120225	For off-hwy, shorter than OE			
		5.0	10x15	5.0	127	254x381	127	2.1	29	2	M120365	Aftermarket			
		5.0	10x15	5.0	127	254x381	127	2.2	30	2	M120448	OE replacement			
		6.0	10x15	6.0	152	254x381	152	1.1	15	2	M122300	For off-hwy, shorter than OE			
Series 50 (8.7 Ltr)	300 to 350	3.0	11.0	4.0	76	279	102	2.5	33	1	M111029	OE replacement			
		4.0	11.0	5.0	102	279	127	2.1	28	2	M111028	Inlet dimension is OD			
		4.0	10x15	4.0	102	254x381	102	3.0	40	2	M120100	Aftermarket, shorter than OE			
		5.0	10x15	5.0	127	254x381	127	2.2	30	2	M120108	For off-hwy, shorter than OE			
		5.0	10x15	5.0	127	254x381	127	1.4	19	2	M120225	For off-hwy, shorter than OE			
		5.0	10x15	5.0	127	254x381	127	2.3	31	2	M120365	Aftermarket			
		5.0	10x15	5.0	127	254x381	127	2.4	33	2	M120448	OE replacement			
		6.0	10x15	6.0	152	254x381	152	1.2	16	2	M122300	For off-hwy, shorter than OE			
Series 60 (12.7 Ltr)	330 to 400	5.0	10x15	5.0	127	254x381	127	2.2	30	2	M120225	For off-hwy, shorter than OE			
		6.0	10x15	6.0	152	254x381	152	1.9	25	2	M122300	For off-hwy, shorter than OE			
Series 60 (12.7 Ltr)	430	5.0	10x15	5.0	127	254x381	127	2.4	33	2	M120225	For off-hwy, shorter than OE			
		6.0	10x15	6.0	152	254x381	152	2.0	28	2	M122300	For off-hwy, shorter than OE			
Series 60 (12.7 Ltr)	470 to 500	5.0	10x15	5.0	127	254x381	127	2.9	39	2	M120225	For off-hwy, shorter than OE			
		6.0	10x15	6.0	152	254x381	152	2.4	32	2	M122300	For off-hwy, shorter than OE			
Series 60 (14 Ltr)	550-575	6.0	10x15	6.0	152	254x381	152	3.0	40	2	M122300	For off-hwy, shorter than OE			
Series 60 (12.7 Ltr)	Cruise Power 330/350 & 370/430	5.0	10x15	5.0	127	254x381	127	2.4	33	2	M120225	For off-hwy, shorter than OE			
		6.0	10x15	6.0	152	254x381	152	2.0	28	2	M122300	For off-hwy, shorter than OE			
Series 60 (12.7 Ltr)	Cruise Power 430/470	5.0	10x15	5.0	127	254x381	127	2.6	35	2	M120225	For off-hwy, shorter than OE			
		6.0	10x15	6.0	152	254x381	152	2.1	29	2	M122300	For off-hwy, shorter than OE			
Series 60 (12.7 Ltr)	Cruise Power 470/500	5.0	10x15	5.0	127	254x381	127	2.9	39	2	M120225	For off-hwy, shorter than OE			
		6.0	10x15	6.0	152	254x381	152	2.4	32	2	M122300	For off-hwy, shorter than OE			
Series 40E	175 to 190	3.0	11.0	4.0	76	279	102	1.6	22	1	M111029	OE replacement			

Truck Engine Muffler Application

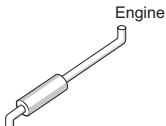

TRUCK ENGINE APPL.

Engine Make & Exhaust System Configuration	Engine Model	H.P.	Muffler Dimensions inches			Muffler Dimensions mm			Backpressure inches of Hg		Muffler Style & Part No.	Notes				
			Inlet	Body	Outlet	Inlet	Body	Outlet	Hg	H ₂ O						
 (7.6 LTA)			4.0	10.0	4.0	102	254	102	2.7	36	2	M100048	Aftermarket			
			4.0	11.0	4.0	102	279	102	2.6	35	2	M110012				
			4.0	11.0	4.0	102	279	102	2.3	32	2	M110189	OE replacement			
			4.0	11.0	5.0	102	279	127	1.4	18	2	M111028	Inlet dimension is OD			
			4.0	8.3x11.5	4.0	102	211x292	102	2.6	36	2	M090280	Aftermarket, shorter than OE			
			4.0	8.3x11.5	4.0	102	211x292	102	2.5	33	2	M090534	Aftermarket, shorter than OE			
			4.0	10x15	4.0	102	254x381	102	1.9	26	2	M120100	Aftermarket, shorter than OE			
			5.0	10x15	5.0	127	254x381	127	1.4	20	2	M120108	For off-hwy, shorter than OE			
			5.0	10x15	5.0	127	254x381	127	0.9	13	2	M120225	For off-hwy, shorter than OE			
			5.0	10x15	5.0	127	254x381	127	1.5	21	2	M120365	Aftermarket			
			5.0	10x15	5.0	127	254x381	127	1.6	21	2	M120448	OE replacement			
			Series 40E (7.6 LTA)	210 to 250		3.0	11.0	4.0	76	279	102	1.9	25	1	M111029	OE replacement
						4.0	11.0	4.0	102	279	102	3.0	40	2	M110012	
						4.0	11.0	4.0	102	279	102	2.7	37	2	M110189	OE replacement
						4.0	11.0	5.0	102	279	127	1.6	21	2	M111028	Inlet dimension is OD
4.0	8.3x11.5	4.0				102	211x292	102	2.8	38	2	M090534	Aftermarket, shorter than OE			
4.0	10x15	4.0				102	254x381	102	2.2	30	2	M120100	Aftermarket, shorter than OE			
5.0	10x15	5.0				127	254x381	127	1.6	22	2	M120108	For off-hwy, shorter than OE			
5.0	10x15	5.0				127	254x381	127	1.1	15	2	M120225	For off-hwy, shorter than OE			
5.0	10x15	5.0				127	254x381	127	1.7	24	2	M120365	Aftermarket			
5.0	10x15	5.0				127	254x381	127	1.8	25	2	M120448	OE replacement			
Series 40E	250 to 275		3.0	11.0	4.0	76	279	102	1.9	26	1	M111029	OE replacement			
			4.0	11.0	4.0	102	279	102	2.8	38	2	M110189	OE replacement			
			4.0	11.0	5.0	102	279	127	1.6	22	2	M111028	Inlet dimension is OD			
			4.0	8.3x11.5	4.0	102	211x292	102	2.9	40	2	M090534	Aftermarket, shorter than OE			
			4.0	10x15	4.0	102	254x381	102	2.3	32	2	M120100	Aftermarket, shorter than OE			
			5.0	10x15	5.0	127	254x381	127	1.7	23	2	M120108	For off-hwy, shorter than OE			
			5.0	10x15	5.0	127	254x381	127	1.1	15	2	M120225	For off-hwy, shorter than OE			
			5.0	10x15	5.0	127	254x381	127	1.8	25	2	M120365	Aftermarket			
			5.0	10x15	5.0	127	254x381	127	1.9	25	2	M120448	OE replacement			
			Series 40E (8.7 LTA)	300 to 330		4.0	11.0	5.0	102	279	127	1.8	24	2	M111028	Inlet dimension is OD
4.0	10x15	4.0				102	254x381	102	2.5	34	2	M120100	Aftermarket, shorter than OE			
5.0	10x15	5.0				127	254x381	127	1.9	25	2	M120108	For off-hwy, shorter than OE			
5.0	10x15	5.0				127	254x381	127	1.2	17	2	M120225	For off-hwy, shorter than OE			
5.0	10x15	5.0				127	254x381	127	2.0	27	2	M120365	Aftermarket			
5.0	10x15	5.0				127	254x381	127	2.0	28	2	M120448	OE replacement			
Series 60 (12.7 Ltr)	330 to 400		5.0	10x15	5.0	127	254x381	127	2.2	30	5	M120131	For off-hwy, shorter than OE			
			5.0	10x15	5.0	127	254x381	127	2.6	36	5	M120450	OE replacement			
Series 60 (12.7 Ltr)	430 to 500		5.0	10x15	5.0	127	254x381	127	2.9	39	5	M120131	For off-hwy, shorter than OE			
Series 60 (12.7 Ltr)	Cruise Power 330/350 & 370/430		5.0	10x15	5.0	127	254x381	127	2.4	33	5	M120131	For off-hwy, shorter than OE			
			5.0	10x15	5.0	127	254x381	127	2.9	39	5	M120450	OE replacement			
Series 60 (12.7 Ltr)	Cruise Power 430/470 & 470/500		5.0	10x15	5.0	127	254x381	127	2.6	35	5	M120131	For off-hwy, shorter than OE			
Series 60 (11.1 Ltr)	350 to 365		4.0	11.0	4.0	102	279	102	2.9	40	4	M111025	Inlet & outlet dimension is OD			
			5.0	11.0	5.0	127	279	127	1.9	26	4	M110014	OE replacement			
			5.0	10x15	5.0	127	254x381	127	2.0	27	4	M120366	OE replacement			
Series 50 (8.7 Ltr)	250 to 275		4.0	11.0	4.0	102	279	102	2.7	37	4	M110112				
			4.0	11.0	4.0	102	279	102	2.7	37	4	M110148				
			4.0	11.0	4.0	102	279	102	2.7	37	4	M110311	Inlet dimension is OD			
			4.0	11.0	4.0	102	279	102	2.4	32	4	M111025	Inlet & outlet dimension is OD			
			5.0	11.0	5.0	127	279	127	1.5	21	4	M110014	OE replacement			
			5.0	10x15	5.0	127	254x381	127	1.6	22	4	M120366	OE replacement			
			5.0	10x15	5.0	127	254x381	127	2.6	35	4	M120417	Aftermarket, shorter than OE			
Series 50 (8.7 Ltr)	300		4.0	11.0	4.0	102	279	102	2.6	36	4	M111025	Inlet & outlet dimension is OD			
			5.0	11.0	5.0	127	279	127	1.7	23	4	M110014	OE replacement			
			5.0	10x15	5.0	127	254x381	127	1.8	24	4	M120366	OE replacement			
			5.0	10x15	5.0	127	254x381	127	2.9	39	4	M120417	Aftermarket, shorter than OE			
Series 50 (8.7 Ltr)	315 to 350		4.0	11.0	4.0	102	279	102	3.0	40	4	M111025	Inlet & outlet dimension is OD			
			5.0	11.0	5.0	127	279	127	2.0	27	4	M110014	OE replacement			
			5.0	10x15	5.0	127	254x381	127	2.1	28	4	M120366	OE replacement			
Series 40E (7.6 LTA)	175-195		4.0	10.0	4.0	102	254	102	2.8	38	4	M100052				
			4.0	11.0	4.0	102	279	102	2.3	31	4	M110112				
			4.0	11.0	4.0	102	279	102	2.3	31	4	M110148				
			4.0	11.0	4.0	102	279	102	2.3	31	4	M110311	Inlet dimension is OD			

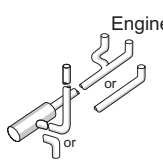
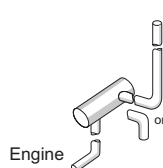
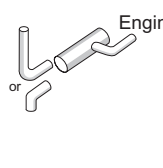
Engine Make & Exhaust System Configuration	Engine Model	H.P.	Muffler Dimensions inches			Muffler Dimensions mm			Backpressure inches of Hg / H ₂ O		Muffler Style & Part No.	Notes	
			Inlet	Body	Outlet	Inlet	Body	Outlet	Hg	H ₂ O			
	Series 40E (7.6 LTA)	210 to 250	4.0	11.0	4.0	102	279	102	2.0	27	4	M111025	Inlet & outlet dimension is OD
			4.0	10x15	4.0	102	254x381	102	2.7	36	4	M120367	Aftermarket, shorter than OE
			5.0	11.0	5.0	127	279	127	1.3	18	4	M110014	OE replacement
			5.0	10x15	5.0	127	254x381	127	1.4	19	4	M120366	OE replacement
			5.0	10x15	5.0	127	254x381	127	2.2	30	4	M120417	Aftermarket, shorter than OE
	Series 40E (8.7 LTA)	250 to 275	4.0	11.0	4.0	102	279	102	2.6	36	4	M110112	
			4.0	11.0	4.0	102	279	102	2.6	36	4	M110148	
			4.0	11.0	4.0	102	279	102	2.6	36	4	M110311	Inlet dimension is OD
			4.0	11.0	4.0	102	279	102	2.3	31	4	M111025	Inlet & outlet dimension is OD
			5.0	11.0	5.0	127	279	127	1.5	20	4	M110014	OE replacement
			5.0	10x15	5.0	127	254x381	127	1.6	21	4	M120366	OE replacement
			5.0	10x15	5.0	127	254x381	127	2.5	34	4	M120417	Aftermarket, shorter than OE
			5.0	10x15	5.0	127	254x381	127	2.6	36	4	M120417	Aftermarket, shorter than OE
	Series 40E (8.7 LTA)	300 to 320	4.0	11.0	4.0	102	279	102	3.0	40	4	M110112	
			4.0	11.0	4.0	102	279	102	3.0	40	4	M110148	
4.0			11.0	4.0	102	279	102	3.0	40	4	M110311	Inlet dimension is OD	
4.0			11.0	4.0	102	279	102	2.6	35	4	M111025	Inlet & outlet dimension is OD	
5.0			11.0	5.0	127	279	127	1.7	23	4	M110014	OE replacement	
5.0			10x15	5.0	127	254x381	127	1.8	24	4	M120366	OE replacement	
5.0			10x15	5.0	127	254x381	127	2.8	39	4	M120417	Aftermarket, shorter than OE	
5.0			10x15	5.0	127	254x381	127	2.8	39	4	M120417	Aftermarket, shorter than OE	
	8.2T	205	4.0	10.0	4.0	102	254	102	1.8	25	6	M100572	
			4.0	11.0	4.0	102	279	102	1.4	19	6	M111026	Outlet dimension is OD
			5.0	10x15	5.0	127	254x381	127	0.9	13	6	M120418	For off-hwy, shorter than OE
	Series 60 (11.1 Ltr)	350 to 365	5.0	10x15	5.0	127	254x381	127	2.1	28	6	M120418	For off-hwy, shorter than OE
	Series 50 (8.7 Ltr)	250 to 275	4.0	11.0	4.0	102	279	102	2.6	35	6	M111026	Outlet dimension is OD
			5.0	10x15	5.0	127	254x381	127	1.7	23	6	M120418	For off-hwy, shorter than OE
	Series 50 (8.7 Ltr)	300	4.0	11.0	4.0	102	279	102	2.9	39	6	M111026	Outlet dimension is OD
			5.0	10x15	5.0	127	254x381	127	1.9	26	6	M120418	For off-hwy, shorter than OE
	Series 50 (8.7 Ltr)	320 to 350	5.0	10x15	5.0	127	254x381	127	2.2	29	6	M120418	For off-hwy, shorter than OE
	Series 40E (7.6 LTA)	175 to 195	4.0	10.0	4.0	102	254	102	2.9	40	6	M100572	
			4.0	11.0	4.0	102	279	102	2.3	31	6	M111026	Outlet dimension is OD
			5.0	10x15	5.0	127	254x381	127	1.5	20	6	M120418	For off-hwy, shorter than OE
	Series 40E (7.6 LTA)	210 to 250	4.0	11.0	4.0	102	279	102	2.5	34	6	M111026	Outlet dimension is OD
			5.0	10x15	5.0	127	254x381	127	1.6	22	6	M120418	For off-hwy, shorter than OE
	Series 40E (8.7 LTA)	250 to 275	4.0	11.0	4.0	102	279	102	2.6	36	6	M111026	Outlet dimension is OD
5.0			10x15	5.0	127	254x381	127	1.7	23	6	M120418	For off-hwy, shorter than OE	
Series 40E (8.7 LTA)	300 to 320	4.0	11.0	4.0	102	279	102	2.8	39	6	M111026	Outlet dimension is OD	
		5.0	10x15	5.0	127	254x381	127	1.9	25	6	M120418	For off-hwy, shorter than OE	
	Series 60 (11.1 Ltr)	350 to 365	5.0	10x15		127	254x381		2.6	36	3	M120235	OE replacement
	Series 50 (8.7 Ltr)	250 to 275	4.0	11.0	5.0	102	279		3.0	40	3	M111024	Outlet has down spout
			5.0	10x15	5.0	127	254x381	127	2.1	29	3	M120235	OE replacement
	Series 50 (8.7 Ltr)	300	5.0	10x15	5.0	127	254x381	127	2.3	32	3	M120235	OE replacement
	Series 50 (8.7 Ltr)	320	5.0	10x15	5.0	127	254x381	127	2.4	33	3	M120235	OE replacement
	Series 50 (8.7 Ltr)	350	5.0	10x15	5.0	127	254x381	127	2.7	37	3	M120235	OE replacement
			5.0	10x15	5.0	127	254x381	127	2.7	37	3	M120235	OE replacement
	Series 40E (7.6 LTA)	175 to 195	4.0	11.0	4.0	102	279	102	2.6	36	3	M110479	
			4.0	11.0	4.0	102	279	102	2.4	33	3	M110674	Band clamp on inlet
			4.0	11.0	4.0	102	279	102	2.4	32	3	M111024	Outlet has down spout
			5.0	10x15	5.0	127	254x381	127	1.6	21	3	M120235	OE replacement
	Series 40E (7.6 LTA)	210 to 250	5.0	10x15	5.0	127	254x381	127	2.0	28	3	M120235	OE replacement
	Series 40E	250	4.0	11.0	4.0	102	279	102	3.0	40	3	M110674	Band clamp on inlet

TRUCK ENGINE APPL.

Truck Engine Muffler Application

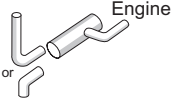

TRUCK ENGINE APPL.

Engine Make & Exhaust System Configuration	Engine Model	H.P.	Muffler Dimensions inches			Muffler Dimensions mm			Backpressure inches of Hg H ₂ O		Muffler Style & Part No.	Notes	
			Inlet	Body	Outlet	Inlet	Body	Outlet					
 Engine (8.7 LTA)			4.0	11.0		102	279		2.9	39	3	M111024	Outlet has down spout
			5.0	10x15	5.0	127	254x381	127	1.9	26	3	M120235	OE replacement
Series 40E (8.7 LTA)	275 to 300		5.0	10x15	5.0	127	254x381	127	2.2	30	3	M120235	OE replacement
Series 40E (8.7 LTA)	320		5.0	10x15	5.0	127	254x381	127	2.3	31	3	M120235	OE replacement

International

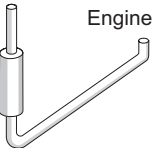
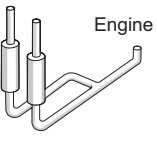
 Engine	DT817	385	4.0	8.5	4.0	102	216	102	1.7	23	1	M085171			
			4.0	9.0	5.0	102	229	127	2.4	33	1	M090781			
			5.0	9.0	5.0	127	229	127	2.0	28	1	M090074			
			5.0	9.0	5.0	127	229	127	1.1	15	1	M090535	Low backpressure, off-hwy		
			5.0	10.0	5.0	127	254	127	1.1	15	1	M100463	Low backpressure, off-hwy		
			5.0	10.0	5.0	127	254	127	2.2	30	1	M100465	Best value, most popular		
			5.0	10.0	5.0	127	254	127	2.3	31	1	M100580	OE replacement		
			5.0	10.0	5.0	127	254	127	2.5	34	1	M100807	60" (1524mm) Long Body		
			5.0	10.0	5.0	127	254	127	1.8	25	1	M100944	OE replacement for higher HP		
			5.0	10.0	5.0	127	254	127	2.2	30	1	M101158	Silent Partner Stainless		
			5.0	10.0	5.0	127	254	127	2.2	30	1	M101181	Silent Partner Aluminized		
			5.0	10.0	5.0	127	254	127	2.3	31	1	M101263	Freightliner only		
5.0	11.0	5.0	127	279	127	1.8	25	1	M110849						
	DT812B	320	4.0	8.5	4.0	102	216	102	1.7	23	1	M085171			
			4.0	9.0	5.0	102	229	127	2.4	33	1	M090781			
			5.0	9.0	5.0	127	229	127	2.0	28	1	M090074			
			5.0	9.0	5.0	127	229	127	1.1	15	1	M090535	Low backpressure, off-hwy		
			5.0	10.0	5.0	127	254	127	1.1	15	1	M100463	Low backpressure, off-hwy		
			5.0	10.0	5.0	127	254	127	2.2	30	1	M100465	Best value, most popular		
			5.0	10.0	5.0	127	254	127	2.3	31	1	M100580	OE replacement		
			5.0	10.0	5.0	127	254	127	2.5	34	1	M100807	60" (1524mm) Long Body		
			5.0	10.0	5.0	127	254	127	1.8	25	1	M100944	OE replacement for higher HP		
			5.0	10.0	5.0	127	254	127	2.2	30	1	M101158	Silent Partner Stainless		
			5.0	10.0	5.0	127	254	127	2.2	30	1	M101181	Silent Partner Aluminized		
			5.0	10.0	5.0	127	254	127	2.3	31	1	M101263	Freightliner only		
5.0	11.0	5.0	127	279	127	1.8	25	1	M110849						
	DT817C	420	4.0	8.5	4.0	102	216	102	1.7	23	1	M085171			
			4.0	9.0	5.0	102	229	127	2.4	33	1	M090781			
			5.0	9.0	5.0	127	229	127	2.0	28	1	M090074			
			5.0	9.0	5.0	127	229	127	1.1	15	1	M090535	Low backpressure, off-hwy		
			5.0	10.0	5.0	127	254	127	1.1	15	1	M100463	Low backpressure, off-hwy		
			5.0	10.0	5.0	127	254	127	2.2	30	1	M100465	Best value, most popular		
			5.0	10.0	5.0	127	254	127	2.3	31	1	M100580	OE replacement		
			5.0	10.0	5.0	127	254	127	2.5	34	1	M100807	60" (1524mm) Long Body		
			5.0	10.0	5.0	127	254	127	1.8	25	1	M100944	OE replacement for higher HP		
			5.0	10.0	5.0	127	254	127	2.2	30	1	M101158	Silent Partner Stainless		
			5.0	10.0	5.0	127	254	127	2.2	30	1	M101181	Silent Partner Aluminized		
			5.0	10.0	5.0	127	254	127	2.3	31	1	M101263	Freightliner only		
5.0	11.0	5.0	127	279	127	1.8	25	1	M110849						
 Engine	DT817	385	4.0	9.0	4.0	102	229	102	1.0	14	1	M090544			
			4.0	10.3	4.0	102	262	102	2.0	27	1	M100464	Wrapped muffler		
			4.0	10.0	4.0	102	254	102	1.1	14	1	M100466			
			4.0	10.0	5.0	102	254	127	1.7	23	1	M100695			
			5.0	10.0	5.0	127	254	127	1.3	18	1	M100582	OE replacement		
			5.0	10.0	5.0	127	254	127	1.3	18	1	M101159	Silent Partner Stainless		
			5.0	10.0	5.0	127	254	127	1.3	18	1	M101182	Silent Partner Aluminized		
			5.0	11.0	5.0	127	279	127	0.7	9	1	M110849			
			DT812B	320	4.0	9.0	4.0	102	229	102	1.0	14	1	M090544	
					4.0	10.3	4.0	102	262	102	2.0	27	1	M100464	Wrapped muffler
					4.0	10.0	4.0	102	254	102	1.1	14	1	M100466	
					4.0	10.0	5.0	102	254	127	1.7	23	1	M100695	
5.0	10.0	5.0			127	254	127	1.3	18	1	M100582	OE replacement			
5.0	10.0	5.0			127	254	127	1.3	18	1	M101159	Silent Partner Stainless			
DT817C	420	4.0	9.0	4.0	102	229	102	1.0	14	1	M090544				
		4.0	10.3	4.0	102	262	102	2.0	27	1	M100464	Wrapped muffler			
		4.0	10.0	4.0	102	254	102	1.1	14	1	M100466				
		4.0	10.0	5.0	102	254	127	1.7	23	1	M100695				
		5.0	10.0	5.0	127	254	127	1.3	18	1	M100582	OE replacement			
		5.0	10.0	5.0	127	254	127	1.3	18	1	M101159	Silent Partner Stainless			

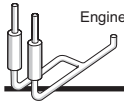
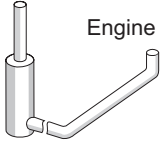
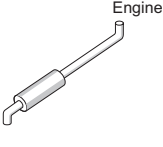
Engine Make & Exhaust System Configuration	Engine Model	H.P.	Muffler Dimensions inches			Muffler Dimensions mm			Backpressure inches of Hg H ₂ O		Muffler Style & Part No.	Notes			
			Inlet	Body	Outlet	Inlet	Body	Outlet	Hg	H ₂ O					
			5.0	10.0	5.0	127	254	127	1.3	18	1	M101159	Silent Partner Stainless		
			5.0	10.0	5.0	127	254	127	1.3	18	1	M101182	Silent Partner Aluminized		
			5.0	11.0	5.0	127	279	127	0.7	9	1	M110849			
	6.9L	170	4.0	10.0	4.0	102	254	102	1.1	15	3	M100146			
	7.3L (T444)	175	4.0	10.0	4.0	102	254	102	1.3	17	3	M100146			
	9.0L	185	4.0	9.0	5.0	102	229	127	0.6	9	3	M090823			
			4.0	10.0	4.0	102	254	102	1.8	24	3	M100146			
			4.0	11.8	5.0	102	300	127	0.7	9	3	M120598			
			5.0	10.0	5.0	127	254	127	0.6	8	3	M100213			
	DT360	190	4.0	9.0	5.0	102	229	127	1.1	15	3	M090823			
			4.0	11.8	5.0	102	300	127	1.2	16	3	M120598			
			5.0	10.0	5.0	127	254	127	1.0	14	3	M100213			
	DT466E	195 to 275	4.0	9.0	5.0	102	229	127	1.7	22	3	M090823			
			4.0	11.8	5.0	102	300	127	1.7	24	3	M120598			
			5.0	10.0	5.0	127	254	127	1.5	21	3	M100213			
	DT414	220	4.0	9.0	5.0	102	229	127	0.7	9	3	M090823			
			4.0	10.0	4.0	102	254	102	1.9	26	3	M100146			
			4.0	11.8	5.0	102	300	127	0.7	10	3	M120598			
5.0			10.0	5.0	127	254	127	0.6	9	3	M100213				
DT420	225	4.0	10.0	4.0	102	254	102	1.6	21	3	M100146				
	6.9L	170	3.0	8.5	3.0	76	216	76	1.6	22	2	M085023			
			3.0	8.5	3.0	76	216	76	1.6	22	2	M085056			
			3.0	8.5	3.0	76	216	76	2.0	28	2	M085078			
			3.0	8.3x11.5	3.0	76	211x292	76	2.9	39	2	M090170			
			3.0	8.5x11.8	3.0	76	216x300	76	2.9	39	2	M090159	Wrapped muffler		
			3.5	8.5	3.0	89	216	76	1.5	20	2	M085008			
			3.5	8.3x11.5	3.5	89	211x292	89	1.1	15	2	M090158			
			3.5	8.3x11.5	4.0	89	211x292	102	0.7	9	2	M090680	OE replacement		
			3.5	8.5x11.8	3.5	89	216x300	89	1.1	15	2	M090210	Wrapped muffler		
			4.0	10.0	4.0	102	254	102	0.7	9	2	M100048	Aftermarket		
			4.0	11.0	4.0	102	279	102	0.7	9	2	M110012			
			4.0	11.0	4.0	102	279	102	0.6	8	2	M110189	OE replacement		
			4.0	8.3x11.5	3.5	102	211x292	89	1.1	15	2	M090538			
			4.0	8.3x11.5	4.0	102	211x292	102	0.7	9	2	M090280	Aftermarket, shorter than OE		
			4.0	8.3x11.5	4.0	102	211x292	102	0.6	9	2	M090534	Aftermarket, shorter than OE		
			4.0	10.3x15.3	4.0	102	261x389	102	1.0	14	2	M120197	Wrapped muffler, OE		
			7.3L (T444)	175	3.0	8.5	3.0	76	216	76	1.8	24	2	M085023	
					3.0	8.5	3.0	76	216	76	1.8	24	2	M085056	
					3.0	8.5	3.0	76	216	76	2.3	31	2	M085078	
					3.5	8.5	3.0	89	216	76	1.7	23	2	M085008	
3.5	8.3x11.5	3.5			89	211x292	89	1.3	17	2	M090158				
3.5	8.3x11.5	4.0			89	211x292	102	0.8	10	2	M090680	OE replacement			
3.5	8.5x11.8	3.5			89	216x300	89	1.3	17	2	M090210	Wrapped muffler			
4.0	10.0	4.0			102	254	102	0.8	10	2	M100048	Aftermarket			
4.0	11.0	4.0			102	279	102	0.7	10	2	M110012				
4.0	11.0	4.0			102	279	102	0.7	9	2	M110189	OE replacement			
4.0	8.3x11.5	3.5			102	211x292	89	1.2	17	2	M090538				
4.0	8.3x11.5	4.0			102	211x292	102	0.8	10	2	M090280	Aftermarket, shorter than OE			
4.0	8.3x11.5	4.0			102	211x292	102	0.7	10	2	M090534	Aftermarket, shorter than OE			
4.0	10.3x15.3	4.0			102	261x389	102	1.2	16	2	M120197	Wrapped muffler, OE			
9.0L	185	3.0	8.5	3.0	76	216	76	2.5	34	2	M085023				
		3.0	8.5	3.0	76	216	76	2.5	34	2	M085056				
		3.0	11.0	4.0	76	279	102	0.7	9	1	M111029	OE replacement			
		3.5	8.5	3.0	89	216	76	2.4	33	2	M085008				
		3.5	8.3x11.5	3.5	89	211x292	89	1.8	25	2	M090158				
		3.5	8.3x11.5	4.0	89	211x292	102	1.1	15	2	M090680	OE replacement			
		3.5	8.5x11.8	3.5	89	216x300	89	1.8	25	2	M090210	Wrapped muffler			
		4.0	10.0	4.0	102	254	102	1.1	15	2	M100048	Aftermarket			
		4.0	11.0	4.0	102	279	102	1.1	14	2	M110012				
		4.0	11.0	4.0	102	279	102	1.0	13	2	M110189	OE replacement			
		4.0	10x15	4.0	102	254x381	102	0.8	11	2	M120100	Aftermarket, shorter than OE			
		4.0	8.3x11.5	3.5	102	211x292	89	1.8	24	2	M090538				
		4.0	8.3x11.5	4.0	102	211x292	102	1.1	15	2	M090280	Aftermarket, shorter than OE			
		4.0	8.3x11.5	4.0	102	211x292	102	1.0	14	2	M090534	Aftermarket, shorter than OE			
		4.0	10.3x15.3	4.0	102	261x389	102	1.7	22	2	M120197	Wrapped muffler, OE			
		5.0	10x15	5.0	127	254x381	127	0.6	8	2	M120365	Aftermarket			

Truck Engine Muffler Application



TRUCK ENGINE APPL.

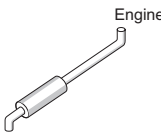

Engine Make & Exhaust System Configuration	Engine Model	Engine H.P.	Muffler Dimensions inches			Muffler Dimensions mm			Backpressure inches of Hg		Muffler Style & Part No.	Notes		
			Inlet	Body	Outlet	Inlet	Body	Outlet	Hg	H ₂ O				
DT360	190	5.0	10x15	5.0	127	254x381	127	0.6	9	2	M120448	OE replacement		
		3.0	11.0	4.0	76	279	102	1.2	16	1	M111029	OE replacement		
		3.5	8.3x11.5	4.0	89	211x292	102	1.9	26	2	M090680	OE replacement		
		4.0	10.0	4.0	102	254	102	2.0	27	2	M100048	Aftermarket		
		4.0	11.0	4.0	102	279	102	1.9	26	2	M110012			
		4.0	11.0	4.0	102	279	102	1.7	23	2	M110189	OE replacement		
		4.0	11.0	5.0	102	279	127	1.0	14	2	M111028	Inlet dimension is OD		
		4.0	10x15	4.0	102	254x381	102	1.4	19	2	M120100	Aftermarket, shorter than OE		
		4.0	8.3x11.5	4.0	102	211x292	102	1.9	26	2	M090280	Aftermarket, shorter than OE		
		4.0	8.3x11.5	4.0	102	211x292	102	1.8	24	2	M090534	Aftermarket, shorter than OE		
		4.0	10.3x15.3	4.0	102	261x389	102	2.9	40	2	M120197	Wrapped muffler, OE		
		5.0	10x15	5.0	127	254x381	127	1.1	14	2	M120108	For off-hwy, shorter than OE		
		5.0	10x15	5.0	127	254x381	127	0.7	9	2	M120225	For off-hwy, shorter than OE		
		5.0	10x15	5.0	127	254x381	127	1.1	15	2	M120365	Aftermarket		
		5.0	10x15	5.0	127	254x381	127	1.2	16	2	M120448	OE replacement		
DT466E	195 to 210	3.0	11.0	4.0	76	279	102	1.5	20	1	M111029	OE replacement		
		3.5	8.3x11.5	4.0	89	211x292	102	2.4	32	2	M090680	OE replacement		
		4.0	10.0	4.0	102	254	102	2.4	33	2	M100048	Aftermarket		
		4.0	11.0	4.0	102	279	102	2.3	32	2	M110012			
		4.0	11.0	4.0	102	279	102	2.1	29	2	M110189	OE replacement		
		4.0	11.0	5.0	102	279	127	1.2	17	2	M111028	Inlet dimension is OD		
		4.0	8.3x11.5	4.0	102	211x292	102	2.4	32	2	M090280	Aftermarket, shorter than OE		
		4.0	8.3x11.5	4.0	102	211x292	102	2.2	30	2	M090534	Aftermarket, shorter than OE		
		4.0	10x15	4.0	102	254x381	102	1.8	24	2	M120100	Aftermarket, shorter than OE		
		5.0	10x15	5.0	127	254x381	127	1.3	18	2	M120108	For off-hwy, shorter than OE		
		5.0	10x15	5.0	127	254x381	127	0.8	12	2	M120225	For off-hwy, shorter than OE		
		5.0	10x15	5.0	127	254x381	127	1.4	19	2	M120365	Aftermarket		
		5.0	10x15	5.0	127	254x381	127	1.4	19	2	M120448	OE replacement		
		DT466E	230 to 275	3.0	11.0	4.0	76	279	102	1.7	24	1	M111029	OE replacement
				3.5	8.3x11.5	4.0	89	211x292	102	2.8	39	2	M090680	OE replacement
4.0	10.0			4.0	102	254	102	2.9	39	2	M100048	Aftermarket		
4.0	11.0			4.0	102	279	102	2.8	38	2	M110012			
4.0	11.0			4.0	102	279	102	2.5	34	2	M110189	OE replacement		
4.0	11.0			5.0	102	279	127	1.5	20	2	M111028	Inlet dimension is OD		
4.0	8.3x11.5			4.0	102	211x292	102	2.8	39	2	M090280	Aftermarket, shorter than OE		
4.0	8.3x11.5			4.0	102	211x292	102	2.7	36	2	M090534	Aftermarket, shorter than OE		
4.0	10x15			4.0	102	254x381	102	2.1	29	2	M120100	Aftermarket, shorter than OE		
5.0	10x15			5.0	127	254x381	127	1.6	21	2	M120108	For off-hwy, shorter than OE		
5.0	10x15			5.0	127	254x381	127	1.0	14	2	M120225	For off-hwy, shorter than OE		
5.0	10x15			5.0	127	254x381	127	1.6	22	2	M120365	Aftermarket		
5.0	10x15			5.0	127	254x381	127	1.7	23	2	M120448	OE replacement		
DT414	220			3.0	8.5	3.0	76	216	76	2.7	37	2	M085023	
				3.0	8.5	3.0	76	216	76	2.7	37	2	M085056	
		3.0	11.0	4.0	76	279	102	0.7	10	1	M111029	OE replacement		
		3.5	8.5	3.0	89	216	76	2.6	35	2	M085008			
		3.5	8.3x11.5	3.5	89	211x292	89	2.0	27	2	M090158			
		3.5	8.3x11.5	4.0	89	211x292	102	1.2	16	2	M090680	OE replacement		
		3.5	8.5x11.8	3.5	89	216x300	89	2.0	27	2	M090210	Wrapped muffler		
		4.0	10.0	4.0	102	254	102	1.2	16	2	M100048	Aftermarket		
		4.0	11.0	4.0	102	279	102	1.1	16	2	M110012			
		4.0	11.0	4.0	102	279	102	1.0	14	2	M110189	OE replacement		
		4.0	11.0	5.0	102	279	127	0.6	8	2	M111028	Inlet dimension is OD		
		4.0	8.3x11.5	3.5	102	211x292	89	1.9	26	2	M090538			
		4.0	8.3x11.5	4.0	102	211x292	102	1.2	16	2	M090280	Aftermarket, shorter than OE		
		4.0	8.3x11.5	4.0	102	211x292	102	1.1	15	2	M090534	Aftermarket, shorter than OE		
		4.0	10x15	4.0	102	254x381	102	0.9	12	2	M120100	Aftermarket, shorter than OE		
		4.0	10.3x15.3	4.0	102	261x389	102	1.8	24	2	M120197	Wrapped muffler, OE		
		5.0	10x15	5.0	127	254x381	127	0.6	9	2	M120108	For off-hwy, shorter than OE		
		5.0	10x15	5.0	127	254x381	127	0.7	9	2	M120365	Aftermarket		
		5.0	10x15	5.0	127	254x381	127	0.7	9	2	M120448	OE replacement		
		DT420	225	3.0	8.5	3.0	76	216	76	2.2	30	2	M085023	
3.0	8.5			3.0	76	216	76	2.2	30	2	M085056			
3.0	8.5			3.0	76	216	76	2.8	39	2	M085078			
3.5	8.5			3.0	89	216	76	2.1	28	2	M085008			
3.5	8.3x11.5			3.5	89	211x292	89	1.6	21	2	M090158			
3.5	8.3x11.5			4.0	89	211x292	102	0.9	13	2	M090680	OE replacement		
3.5	8.5x11.8			3.5	89	216x300	89	1.6	21	2	M090210	Wrapped muffler		
4.0	10.0			4.0	102	254	102	1.0	13	2	M100048	Aftermarket		

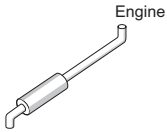
Engine Make & Exhaust System Configuration	Engine Model	H.P.	Muffler Dimensions inches			Muffler Dimensions mm			Backpressure inches of Hg / H ₂ O		Muffler Style & Part No.	Notes				
			Inlet	Body	Outlet	Inlet	Body	Outlet	Hg	H ₂ O						
			4.0	11.0	4.0	102	279	102	0.9	13	2	M110012				
			4.0	11.0	4.0	102	279	102	0.8	11	2	M110189	OE replacement			
			4.0	8.3x11.5	3.5	102	211x292	89	1.5	21	2	M090538				
			4.0	8.3x11.5	4.0	102	211x292	102	0.9	13	2	M090280	Aftermarket, shorter than OE			
			4.0	8.3x11.5	4.0	102	211x292	102	0.9	12	2	M090534	Aftermarket, shorter than OE			
			4.0	10x15	4.0	102	254x381	102	0.7	9	2	M120100	Aftermarket, shorter than OE			
			4.0	10.3x15.3	4.0	102	261x389	102	1.4	20	2	M120197	Wrapped muffler, OE			
			5.0	10x15	5.0	127	254x381	127	0.6	8	2	M120448	OE replacement			
			DT817	385		4.0	11.0	5.0	102	279	127	2.8	39	2	M111028	Inlet dimension is OD
						5.0	10x15	5.0	127	254x381	127	2.0	27	2	M120225	For off-hwy, shorter than OE
			6.0	10x15	6.0	152	254x381	152	1.6	22	2	M122300	For off-hwy, shorter than OE			
DT812B	320		4.0	11.0	5.0	102	279	127	2.8	39	2	M111028	Inlet dimension is OD			
			5.0	10x15	5.0	127	254x381	127	2.0	27	2	M120225	For off-hwy, shorter than OE			
			6.0	10x15	6.0	152	254x381	152	1.6	22	2	M122300	For off-hwy, shorter than OE			
DT817C	420		4.0	11.0	5.0	102	279	127	2.8	39	2	M111028	Inlet dimension is OD			
			5.0	10x15	5.0	127	254x381	127	2.0	27	2	M120225	For off-hwy, shorter than OE			
			6.0	10x15	6.0	152	254x381	152	1.6	22	2	M122300	For off-hwy, shorter than OE			
DT817	385		5.0	10x15	5.0	127	254x381	127	2.0	27	5	M120131	For off-hwy, shorter than OE			
			5.0	10x15	5.0	127	254x381	127	2.3	31	5	M120450	OE replacement			
DT812B	320		5.0	10x15	5.0	127	254x381	127	2.0	27	5	M120131	For off-hwy, shorter than OE			
			5.0	10x15	5.0	127	254x381	127	2.3	31	5	M120450	OE replacement			
DT817C	420		5.0	10x15	5.0	127	254x381	127	2.0	27	5	M120131	For off-hwy, shorter than OE			
			5.0	10x15	5.0	127	254x381	127	2.3	31	5	M120450	OE replacement			
6.9L	170		3.5	8.3x11.5	4.0	89	211x292	102	0.9	12	4	M090547	OE replacement			
			4.0	10.0	4.0	102	254	102	0.7	10	4	M100052				
			4.0	11.0	4.0	102	279	102	0.6	8	4	M110112				
			4.0	10x15	4.0	102	254x381	102	0.7	9	4	M120367	Aftermarket, shorter than OE			
			5.0	10x15	5.0	127	254x381	127	0.6	8	4	M120417	Aftermarket, shorter than OE			
7.3L (T444)	175		3.5	8.3x11.5	4.0	89	211x292	102	1.0	13	4	M090547	OE replacement			
			3.5	8.3x11.5	4.0 OD	89	211x292	102 OD	0.6	8	4	M090548	OE replacement			
			4.0	10.0	4.0	102	254	102	0.8	11	4	M100052				
			4.0	11.0	4.0	102	279	102	0.7	9	4	M110112				
			4.0	11.0	4.0	102	279	102	0.7	9	4	M110148				
			4.0	11.0	4.0	102	279	102	0.7	9	4	M110311	Inlet dimension is OD			
			4.0	11.0	4.0	102	279	102	0.6	8	4	M111025	Inlet & outlet dimension is OD			
			4.0	10x15	4.0	102	254x381	102	0.8	10	4	M120367	Aftermarket, shorter than OE			
			5.0	10x15	5.0	127	254x381	127	0.6	9	4	M120417	Aftermarket, shorter than OE			
9.0L	185		3.5	8.3x11.5	4.0	89	211x292	102	1.4	19	4	M090547	OE replacement			
			3.5	8.3x11.5	4.0 OD	89	211x292	102 OD	0.9	12	4	M090548	OE replacement			
			4.0	10.0	4.0	102	254	102	1.1	15	4	M100052				
			4.0	11.0	4.0	102	279	102	0.9	13	4	M110112				
			4.0	11.0	4.0	102	279	102	0.9	13	4	M110148				
			4.0	11.0	4.0	102	279	102	0.9	13	4	M110311	Inlet dimension is OD			
			4.0	11.0	4.0	102	279	102	0.8	11	4	M111025	Inlet & outlet dimension is OD			
			5.0	10x15	5.0	127	254x381	127	0.6	8	4	M120366	OE replacement			
			4.0	10x15	4.0	102	254x381	102	1.1	15	4	M120367	Aftermarket, shorter than OE			
			5.0	10x15	5.0	127	254x381	127	0.9	12	4	M120417	Aftermarket, shorter than OE			
DT360	190		3.5	8.3x11.5	4.0	89	211x292	102	2.5	34	4	M090547	OE replacement			
			3.5	8.3x11.5	4.0 OD	89	211x292	102 OD	1.6	21	4	M090548	OE replacement			
			4.0	10.0	4.0	102	254	102	2.0	27	4	M100052				
			5.0	11.0	5.0	127	279	127	0.9	13	4	M110014	OE replacement			
			4.0	11.0	4.0	102	279	102	1.7	23	4	M110112				
			4.0	11.0	4.0	102	279	102	1.7	23	4	M110148				
			4.0	11.0	4.0	102	279	102	1.7	23	4	M110311	Inlet dimension is OD			
			4.0	11.0	4.0	102	279	102	1.5	20	4	M111025	Inlet & outlet dimension is OD			
			5.0	10x15	5.0	127	254x381	127	1.0	14	4	M120366	OE replacement			
			4.0	10x15	4.0	102	254x381	102	2.0	27	4	M120367	Aftermarket, shorter than OE			
			5.0	10x15	5.0	127	254x381	127	1.6	22	4	M120417	Aftermarket, shorter than OE			
DT466E	195 to 210		3.5	8.3x11.5	4.0 OD	89	211x292	102 OD	1.9	26	4	M090548	OE replacement			
			4.0	10.0	4.0	102	254	102	2.5	34	4	M100052				
			4.0	11.0	4.0	102	279	102	2.0	28	4	M110112				
			4.0	11.0	4.0	102	279	102	2.0	28	4	M110148				
			4.0	11.0	4.0	102	279	102	2.0	28	4	M110311	Inlet dimension is OD			
			4.0	11.0	4.0	102	279	102	1.8	24	4	M111025	Inlet & outlet dimension is OD			
			4.0	10x15	4.0	102	254x381	102	2.4	33	4	M120367	Aftermarket, shorter than OE			
			5.0	11.0	5.0	127	279	127	1.2	16	4	M110014	OE replacement			
			5.0	10x15	5.0	127	254x381	127	1.2	17	4	M120366	OE replacement			

Truck Engine Muffler Application



TRUCK ENGINE APPL.

Engine Make & Exhaust System Configuration	Engine Model	H.P.	Muffler Dimensions inches			Muffler Dimensions mm			Backpressure inches of Hg H ₂ O		Muffler Style & Part No.	Notes			
			Inlet	Body	Outlet	Inlet	Body	Outlet							
	DT466E	230 to 275	5.0	10x15	5.0	127	254x381	127	2.0	27	4	M120417	Aftermarket, shorter than OE		
			3.5	8.3x11.5	4.0 OD	89	211x292	102 OD	2.3	31	4	M090548	OE replacement		
			4.0	11.0	4.0	102	279	102	2.5	33	4	M110112			
			4.0	11.0	4.0	102	279	102	2.5	33	4	M110148			
			4.0	11.0	4.0	102	279	102	2.5	33	4	M110311	Inlet dimension is OD		
			4.0	11.0	4.0	102	279	102	2.2	29	4	M111025	Inlet & outlet dimension is OD		
			4.0	10x15	4.0	102	254x381	102	2.9	39	4	M120367	Aftermarket, shorter than OE		
			5.0	11.0	5.0	127	279	127	1.4	19	4	M110014	OE replacement		
			5.0	10x15	5.0	127	254x381	127	1.5	20	4	M120366	OE replacement		
			5.0	10x15	5.0	127	254x381	127	2.4	32	4	M120417	Aftermarket, shorter than OE		
			DT414	220	3.5	8.3x11.5	4.0	89	211x292	102	1.5	21	4	M090547	OE replacement
					3.5	8.3x11.5	4.0 OD	89	211x292	102 OD	0.9	13	4	M090548	OE replacement
					4.0	10.0	4.0	102	254	102	1.2	17	4	M100052	
					4.0	11.0	4.0	102	279	102	1.0	14	4	M110112	
4.0	11.0	4.0			102	279	102	1.0	14	4	M110148				
4.0	11.0	4.0			102	279	102	1.0	14	4	M110311	Inlet dimension is OD			
4.0	11.0	4.0			102	279	102	0.9	12	4	M111025	Inlet & outlet dimension is OD			
4.0	10x15	4.0			102	254x381	102	1.2	16	4	M120367	Aftermarket, shorter than OE			
5.0	11.0	5.0			127	279	127	0.6	8	4	M110014	OE replacement			
5.0	10x15	5.0			127	254x381	127	0.6	8	4	M120366	OE replacement			
5.0	10x15	5.0			127	254x381	127	1.0	13	4	M120417	Aftermarket, shorter than OE			
DT420	225	3.5			8.3x11.5	4.0	89	211x292	102	1.2	17	4	M090547	OE replacement	
		3.5			8.3x11.5	4.0 OD	89	211x292	102 OD	0.8	10	4	M090548	OE replacement	
		4.0			10.0	4.0	102	254	102	1.0	13	4	M100052		
		4.0	11.0	4.0	102	279	102	0.8	11	4	M110112				
		4.0	11.0	4.0	102	279	102	0.8	11	4	M110148				
		4.0	11.0	4.0	102	279	102	0.8	11	4	M110311	Inlet dimension is OD			
		4.0	11.0	4.0	102	279	102	0.7	10	4	M111025	Inlet & outlet dimension is OD			
		4.0	10x15	4.0	102	254x381	102	1.0	13	4	M120367	Aftermarket, shorter than OE			
		5.0	10x15	5.0	127	254x381	127	0.8	11	4	M120417	Aftermarket, shorter than OE			
		DT817	385	5.0	11.0	5.0	127	279	127	2.7	37	4	M110014	OE replacement	
5.0	10x15			5.0	127	254x381	127	2.8	39	4	M120366	OE replacement			
DT812B	320	5.0	11.0	5.0	127	279	127	2.7	37	4	M110014	OE replacement			
		5.0	10x15	5.0	127	254x381	127	2.8	39	4	M120366	OE replacement			
DT817C	420	5.0	11.0	5.0	127	279	127	2.7	37	4	M110014	OE replacement			
		5.0	10x15	5.0	127	254x381	127	2.8	39	4	M120366	OE replacement			
6.9L	170	3.0	8.5	3.0	76	216	76	1.8	24	6	M085208				
		3.5	8.3x11.5	3.5	89	211x292	89	1.5	20	6	M090598				
		4.0	10.0	4.0	102	254	102	0.7	10	6	M100572				
		4.0	11.0	4.0	102	279	102	0.6	8	6	M111026	Outlet dimension is OD			
7.3L (T444)	175	3.0	8.5	3.0	76	216	76	2.0	27	6	M085208				
		3.5	8.3x11.5	3.5	89	211x292	89	1.6	22	6	M090598				
		4.0	10.0	4.0	102	254	102	0.8	11	6	M100572				
		4.0	11.0	4.0	102	279	102	0.6	9	6	M111026	Outlet dimension is OD			
9.0L	185	3.0	8.5	3.0	76	216	76	2.8	38	6	M085208				
		3.5	8.3x11.5	3.5	89	211x292	89	2.3	32	6	M090598				
		4.0	10.0	4.0	102	254	102	1.2	16	6	M100572				
		4.0	11.0	4.0	102	279	102	0.9	12	6	M111026	Outlet dimension is OD			
		5.0	10x15	5.0	127	254x381	127	0.6	8	6	M120418	For off-hwy, shorter than OE			
DT360	190	4.0	10.0	4.0	102	254	102	2.1	28	6	M100572				
		4.0	11.0	4.0	102	279	102	1.6	22	6	M111026	Outlet dimension is OD			
		5.0	10x15	5.0	127	254x381	127	1.0	14	6	M120418	For off-hwy, shorter than OE			
DT466E	195 to 210	4.0	10.0	4.0	102	254	102	2.5	35	6	M100572				
		4.0	11.0	4.0	102	279	102	2.0	27	6	M111026	Outlet dimension is OD			
		5.0	10x15	5.0	127	254x381	127	1.3	17	6	M120418	For off-hwy, shorter than OE			
DT466E	250 to 275	5.0	10x15	5.0	127	254x381	127	1.5	21	6	M120418	For off-hwy, shorter than OE			
		4.0	11.0	4.0	102	279	102	2.4	32	6	M111026	Outlet dimension is OD			
DT414	220	3.5	8.3x11.5	3.5	89	211x292	89	2.5	34	6	M090598				
		4.0	10.0	4.0	102	254	102	1.3	17	6	M100572				
		4.0	11.0	4.0	102	279	102	1.0	13	6	M111026	Outlet dimension is OD			
		5.0	10x15	5.0	127	254x381	127	0.6	9	6	M120418	For off-hwy, shorter than OE			
DT420	225	3.0	8.5	3.0	76	216	76	2.4	33	6	M085208				
		3.5	8.3x11.5	3.5	89	211x292	89	2.0	28	6	M090598				
		4.0	10.0	4.0	102	254	102	1.0	14	6	M100572				
		4.0	11.0	4.0	102	279	102	0.8	11	6	M111026	Outlet dimension is OD			
DT817	385	5.0	10x15	5.0	127	254x381	127	3.0	40	6	M120418	For off-hwy, shorter than OE			

Engine Make & Exhaust System Configuration	Engine Model	H.P.	Muffler Dimensions						Backpressure		Muffler Style & Part No.	Notes
			inches			mm			inches of Hg	H ₂ O		

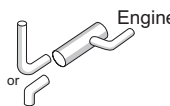
DT812B	320		5.0	10x15	5.0	127	254x381	127	3.0	40	6	M120418	For off-hwy, shorter than OE
DT817C	420		5.0	10x15	5.0	127	254x381	127	3.0	40	6	M120418	For off-hwy, shorter than OE
 6.9L	170		3.5	8.5	3.0	89	216	76	3.0	40	3	M085084	
			3.0	8.8	3.0	76	222	76	2.9	40	3	M085226	Wrapped muffler
			3.5	8.3x11.5	3.5	89	211x292	89	1.6	22	3	M090301	
			4.0	11.0	4.0	102	279	102	0.8	10	3	M110479	
			4.0	11.0	4.0	102	279	102	0.7	10	3	M110674	Band clamp on inlet
			4.0	11.0		102	279		0.7	9	3	M111024	Outlet has down spout
7.3L (T444)	175		3.5	8.3x11.5	3.5	89	211x292	89	1.8	24	3	M090301	
			4.0	11.0	4.0	102	279	102	0.9	12	3	M110479	
			4.0	11.0	4.0	102	279	102	0.8	11	3	M110674	Band clamp on inlet
			4.0	11.0		102	279		0.8	10	3	M111024	Outlet has down spout
9.0L	185		3.5	8.3x11.5	3.5	89	211x292	89	2.6	35	3	M090301	
			4.0	11.0	4.0	102	279	102	1.2	17	3	M110479	
			4.0	11.0	4.0	102	279	102	1.1	15	3	M110674	Band clamp on inlet
			4.0	11.0		102	279		1.1	15	3	M111024	Outlet has down spout
			5.0	10x15	5.0	127	254x381	127	0.7	10	3	M120235	OE replacement
DT360	190		4.0	11.0	4.0	102	279	102	2.2	30	3	M110479	
			4.0	11.0	4.0	102	279	102	2.0	27	3	M110674	Band clamp on inlet
			4.0	11.0		102	279		2.0	27	3	M111024	Outlet has down spout
			5.0	10x15	5.0	127	254x381	127	1.3	18	3	M120235	OE replacement
DT466E	195 to 210		4.0	11.0	4.0	102	279	102	2.7	37	3	M110479	
			4.0	11.0	4.0	102	279	102	2.5	34	3	M110674	Band clamp on inlet
			4.0	11.0		102	279		2.4	33	3	M111024	Outlet has down spout
			5.0	10x15	5.0	127	254x381	127	1.6	22	3	M120235	OE replacement
DT466E	250 to 275		4.0	11.0		102	279		2.9	39	3	M111024	Outlet has down spout
			5.0	10x15	5.0	127	254x381	127	1.9	26	3	M120235	OE replacement
DT414	220		3.5	8.3x11.5	3.5	89	211x292	89	2.8	38	3	M090301	
			4.0	11.0	4.0	102	279	102	1.3	18	3	M110479	
			4.0	11.0	4.0	102	279	102	1.2	17	3	M110674	Band clamp on inlet
			4.0	11.0		102	279		1.2	16	3	M111024	Outlet has down spout
			5.0	10x15	5.0	127	254x381	127	0.8	11	3	M120235	OE replacement
DT420	225		3.5	8.3x11.5	3.5	89	211x292	89	2.2	30	3	M090301	
			4.0	11.0	4.0	102	279	102	1.1	15	3	M110479	
			4.0	11.0	4.0	102	279	102	1.0	13	3	M110674	Band clamp on inlet
			4.0	11.0		102	279		1.0	13	3	M111024	Outlet has down spout
			5.0	10x15	5.0	127	254x381	127	0.6	9	3	M120235	OE replacement

Mack

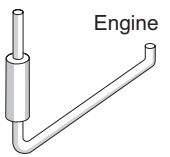
E9	500		5.0	9.0	5.0	127	229	127	1.9	26	1	M090535	Low backpressure, off-hwy		
			5.0	10.0	5.0	127	254	127	1.9	26	1	M100463	Low backpressure, off-hwy		
 ENDT865	325		4.0	8.5	4.0	102	216	102	1.6	22	1	M085171			
			4.0	9.0	5.0	102	229	127	2.3	32	1	M090781			
			5.0	9.0	5.0	127	229	127	2.0	27	1	M090074			
			5.0	9.0	5.0	127	229	127	1.5	20	1	M090535	Low backpressure, off-hwy		
			5.0	10.0	5.0	127	254	127	1.1	14	1	M100463	Low backpressure, off-hwy		
			5.0	10.0	5.0	127	254	127	2.1	29	1	M100465	Best value, most popular		
			5.0	10.0	5.0	127	254	127	2.2	30	1	M100580	OE replacement		
			5.0	10.0	5.0	127	254	127	2.4	33	1	M100807	60" (1524mm) Long Body		
			5.0	10.0	5.0	127	254	127	1.8	24	1	M100944	OE replacement for higher HP		
			5.0	10.0	5.0	127	254	127	2.1	29	1	M101158	Silent Partner Stainless		
			5.0	10.0	5.0	127	254	127	2.1	29	1	M101181	Silent Partner Aluminized		
			5.0	10.0	5.0	127	254	127	2.2	30	1	M101263	Freightliner only		
			5.0	11.0	5.0	127	279	127	1.8	24	1	M110849			
		ENDT866	375		4.0	8.5	4.0	102	216	102	2.0	27	1	M085171	
					4.0	9.0	5.0	102	229	127	2.8	38	1	M090781	
	5.0			9.0	5.0	127	229	127	2.4	32	1	M090074			
	5.0			9.0	5.0	127	229	127	1.3	17	1	M090535	Low backpressure, off-hwy		
	5.0			10.0	5.0	127	254	127	1.3	17	1	M100463	Low backpressure, off-hwy		
	5.0			10.0	5.0	127	254	127	2.5	34	1	M100465	Best value, most popular		
	5.0			10.0	5.0	127	254	127	2.7	36	1	M100580	OE replacement		
	5.0			10.0	5.0	127	254	127	2.9	39	1	M100807	60" (1524mm) Long Body		
	5.0			10.0	5.0	127	254	127	2.1	29	1	M100944	OE replacement for higher HP		
	5.0			10.0	5.0	127	254	127	2.6	35	1	M101158	Silent Partner Stainless		
	5.0			10.0	5.0	127	254	127	2.6	35	1	M101181	Silent Partner Aluminized		
	5.0			10.0	5.0	127	254	127	2.7	36	1	M101263	Freightliner only		
E7 or E6	300 to 350		4.0	8.5	4.0	102	216	102	0.9	12	1	M085171			

Truck Engine Muffler Application

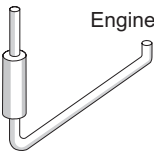

TRUCK ENGINE APPL.

Engine Make & Exhaust System Configuration	Engine Model	H.P.	Muffler Dimensions inches			Muffler Dimensions mm			Backpressure inches of Hg H ₂ O		Muffler Style & Part No.	Notes	
			Inlet	Body	Outlet	Inlet	Body	Outlet					
 Engine			5.0	9.0	5.0	127	229	127	1.1	15	1	M090074	
			5.0	9.0	5.0	127	229	127	0.6	8	1	M090535	Low backpressure, off-hwy
			4.0	9.0	5.0	102	229	127	1.3	17	1	M090781	
			5.0	10.0	5.0	127	254	127	0.6	8	1	M100463	Low backpressure, off-hwy
			5.0	10.0	5.0	127	254	127	1.1	16	1	M100465	Best value, most popular
			5.0	10.0	5.0	127	254	127	1.2	16	1	M100580	OE replacement
			5.0	10.0	5.0	127	254	127	1.3	18	1	M100807	60" (1524mm) Long Body
			5.0	10.0	5.0	127	254	127	1.0	13	1	M100944	OE replacement for higher HP
			5.0	10.0	5.0	127	254	127	1.2	16	1	M101158	Silent Partner Stainless
			5.0	10.0	5.0	127	254	127	1.2	16	1	M101181	Silent Partner Aluminized
5.0	10.0	5.0	127	254	127	1.2	16	1	M101263	Freightliner only			
5.0	11.0	5.0	127	279	127	1.0	13	1	M110849				
E7	400		4.0	8.5	4.0	102	216	102	1.1	15	1	M085171	
			4.0	9.0	5.0	102	229	127	1.6	22	1	M090781	
			5.0	9.0	5.0	127	229	127	1.4	19	1	M090074	
			5.0	9.0	5.0	127	229	127	0.7	10	1	M090535	Low backpressure, off-hwy
			5.0	10.0	5.0	127	254	127	0.7	10	1	M100463	Low backpressure, off-hwy
			5.0	10.0	5.0	127	254	127	1.5	20	1	M100465	Best value, most popular
			5.0	10.0	5.0	127	254	127	1.5	21	1	M100580	OE replacement
			5.0	10.0	5.0	127	254	127	1.7	23	1	M100807	60" (1524mm) Long Body
			5.0	10.0	5.0	127	254	127	1.2	17	1	M100944	OE replacement for higher HP
			5.0	10.0	5.0	127	254	127	1.5	20	1	M101158	Silent Partner Stainless
5.0	10.0	5.0	127	254	127	1.5	20	1	M101181	Silent Partner Aluminized			
5.0	10.0	5.0	127	254	127	1.5	21	1	M101263	Freightliner only			
5.0	11.0	5.0	127	279	127	1.2	17	1	M110849				
E7	427 to 460		4.0	8.5	4.0	102	216	102	1.6	22	1	M085171	
			4.0	9.0	5.0	102	229	127	2.3	31	1	M090781	
			5.0	9.0	5.0	127	229	127	1.9	26	1	M090074	
			5.0	9.0	5.0	127	229	127	1.0	14	1	M090535	Low backpressure, off-hwy
			5.0	10.0	5.0	127	254	127	1.0	14	1	M100463	Low backpressure, off-hwy
			5.0	10.0	5.0	127	254	127	2.1	28	1	M100465	Best value, most popular
			5.0	10.0	5.0	127	254	127	2.2	30	1	M100580	OE replacement
			5.0	10.0	5.0	127	254	127	2.3	32	1	M100807	60" (1524mm) Long Body
			5.0	10.0	5.0	127	254	127	1.7	24	1	M100944	OE replacement for higher HP
			5.0	10.0	5.0	127	254	127	2.1	28	1	M101158	Silent Partner Stainless
5.0	10.0	5.0	127	254	127	2.1	28	1	M101181	Silent Partner Aluminized			
5.0	10.0	5.0	127	254	127	2.2	30	1	M101263	Freightliner only			
5.0	11.0	5.0	127	279	127	1.7	23	1	M110849				
E7	310/330 & 330/355		4.0	8.5	4.0	102	216	102	0.9	12	1	M085171	
			4.0	9.0	5.0	102	229	127	1.2	17	1	M090781	
			5.0	9.0	5.0	127	229	127	1.0	14	1	M090074	
			5.0	9.0	5.0	127	229	127	0.6	8	1	M090535	Low backpressure, off-hwy
			5.0	10.0	5.0	127	254	127	0.6	8	1	M100463	Low backpressure, off-hwy
			5.0	10.0	5.0	127	254	127	1.1	15	1	M100465	Best value, most popular
			5.0	10.0	5.0	127	254	127	1.2	16	1	M100580	OE replacement
			5.0	10.0	5.0	127	254	127	1.3	17	1	M100807	60" (1524mm) Long Body
			5.0	10.0	5.0	127	254	127	0.9	13	1	M100944	OE replacement for higher HP
			5.0	10.0	5.0	127	254	127	1.1	15	1	M101158	Silent Partner Stainless
5.0	10.0	5.0	127	254	127	1.1	15	1	M101181	Silent Partner Aluminized			
5.0	10.0	5.0	127	254	127	1.2	16	1	M101263	Freightliner only			
5.0	11.0	5.0	127	279	127	0.9	13	1	M110849				
E7	355/380		4.0	8.5	4.0	102	216	102	1.0	14	1	M085171	
			5.0	9.0	5.0	127	229	127	1.2	16	1	M090074	
			5.0	9.0	5.0	127	229	127	0.6	9	1	M090535	Low backpressure, off-hwy
			4.0	9.0	5.0	102	229	127	1.4	19	1	M090781	
			5.0	10.0	5.0	127	254	127	0.6	9	1	M100463	Low backpressure, off-hwy
			5.0	10.0	5.0	127	254	127	1.3	17	1	M100465	Best value, most popular
			5.0	10.0	5.0	127	254	127	1.4	18	1	M100580	OE replacement
			5.0	10.0	5.0	127	254	127	1.5	20	1	M100807	60" (1524mm) Long Body
			5.0	10.0	5.0	127	254	127	1.1	15	1	M100944	OE replacement for higher HP
			5.0	10.0	5.0	127	254	127	1.3	18	1	M101158	Silent Partner Stainless
5.0	10.0	5.0	127	254	127	1.3	18	1	M101181	Silent Partner Aluminized			
5.0	10.0	5.0	127	254	127	1.4	18	1	M101263	Freightliner only			
5.0	11.0	5.0	127	279	127	1.1	14	1	M110849				
E9	500		4.0	9.0	4.0	102	229	102	1.7	24	1	M090544	
			4.0	10.0	4.0	102	254	102	1.9	25	1	M100466	
			4.0	10.0	5.0	102	254	127	3.0	40	1	M100695	
			5.0	10.0	5.0	127	254	127	2.3	31	1	M100582	OE replacement
			5.0	10.0	5.0	127	254	127	2.3	31	1	M101159	Silent Partner Stainless
			5.0	10.0	5.0	127	254	127	2.3	31	1	M101182	Silent Partner Aluminized
5.0	11.0	5.0	127	279	127	1.2	17	1	M110849				
ENDT865	325		4.0	9.0	4.0	102	229	102	1.0	13	1	M090544	

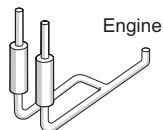

Engine Make & Exhaust System Configuration	Engine Model	H.P.	Muffler Dimensions inches			Muffler Dimensions mm			Backpressure inches of Hg H ₂ O		Muffler Style & Part No.	Notes
			Inlet	Body	Outlet	Inlet	Body	Outlet	Hg	H ₂ O		

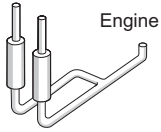

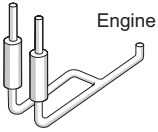
	ENDT866	375	4.0	10.3	4.0	102	262	102	1.9	26	1	M100464	Wrapped muffler
			4.0	10.0	4.0	102	254	102	1.0	14	1	M100466	
			4.0	10.0	5.0	102	254	127	1.6	22	1	M100695	
			5.0	10.0	5.0	127	254	127	1.3	17	1	M100582	OE replacement
			5.0	10.0	5.0	127	254	127	1.3	17	1	M101159	Silent Partner Stainless
			5.0	10.0	5.0	127	254	127	1.3	17	1	M101182	Silent Partner Aluminized
			5.0	11.0	5.0	127	279	127	0.7	9	1	M110849	
			4.0	9.0	4.0	102	229	102	1.2	16	1	M090544	
			4.0	10.3	4.0	102	262	102	2.3	31	1	M100464	Wrapped muffler
			4.0	10.0	4.0	102	254	102	1.2	17	1	M100466	
			4.0	10.0	5.0	102	254	127	2.0	27	1	M100695	
			5.0	10.0	5.0	127	254	127	1.5	21	1	M100582	OE replacement
			5.0	10.0	5.0	127	254	127	1.5	21	1	M101159	Silent Partner Stainless
			5.0	10.0	5.0	127	254	127	1.5	21	1	M101182	Silent Partner Aluminized
			5.0	11.0	5.0	127	279	127	0.8	11	1	M110849	
E7 or E6	300 to 350	4.0	10.3	4.0	102	262	102	1.1	14	1	M100464	Wrapped muffler	
		4.0	10.0	5.0	102	254	127	0.9	12	1	M100695		
		5.0	10.0	5.0	127	254	127	0.7	9	1	M100582	OE replacement	
		5.0	10.0	5.0	127	254	127	0.7	9	1	M101159	Silent Partner Stainless	
		5.0	10.0	5.0	127	254	127	0.7	9	1	M101182	Silent Partner Aluminized	
E7	400	4.0	9.0	4.0	102	229	102	0.7	9	1	M090544		
		4.0	10.3	4.0	102	262	102	1.3	18	1	M100464	Wrapped muffler	
		4.0	10.0	4.0	102	254	102	0.7	10	1	M100466		
		4.0	10.0	5.0	102	254	127	1.1	15	1	M100695		
		5.0	10.0	5.0	127	254	127	0.9	12	1	M100582	OE replacement	
		5.0	10.0	5.0	127	254	127	0.9	12	1	M101159	Silent Partner Stainless	
		5.0	10.0	5.0	127	254	127	0.9	12	1	M101182	Silent Partner Aluminized	
E7	427 to 460	4.0	9.0	4.0	102	229	102	0.9	13	1	M090544		
		4.0	10.3	4.0	102	262	102	1.9	26	1	M100464	Wrapped muffler	
		4.0	10.0	4.0	102	254	102	1.0	14	1	M100466		
		4.0	10.0	5.0	102	254	127	1.6	22	1	M100695		
		5.0	10.0	5.0	127	254	127	1.2	17	1	M100582	OE replacement	
		5.0	10.0	5.0	127	254	127	1.2	17	1	M101159	Silent Partner Stainless	
		5.0	10.0	5.0	127	254	127	1.2	17	1	M101182	Silent Partner Aluminized	
5.0	11.0	5.0	127	279	127	0.7	9	1	M110849				
E7	310/330 & 330/355	4.0	10.3	4.0	102	262	102	1.0	14	1	M100464	Wrapped muffler	
		4.0	10.0	5.0	102	254	127	0.9	12	1	M100695		
		5.0	10.0	5.0	127	254	127	0.7	9	1	M100582	OE replacement	
		5.0	10.0	5.0	127	254	127	0.7	9	1	M101159	Silent Partner Stainless	
		5.0	10.0	5.0	127	254	127	0.7	9	1	M101182	Silent Partner Aluminized	
E7	355/380	4.0	9.0	4.0	102	229	102	0.6	8	1	M090544		
		4.0	10.3	4.0	102	262	102	1.2	16	1	M100464	Wrapped muffler	
		4.0	10.0	4.0	102	254	102	0.6	8	1	M100466		
		5.0	10.0	5.0	127	254	127	0.8	10	1	M100582	OE replacement	
		4.0	10.0	5.0	102	254	127	1.0	14	1	M100695		
		5.0	10.0	5.0	127	254	127	0.8	10	1	M101159	Silent Partner Stainless	
		5.0	10.0	5.0	127	254	127	0.8	10	1	M101182	Silent Partner Aluminized	
ENDT865	325	4.0	9.0	5.0	102	229	127	3.0	40	3	M090823		
		5.0	10.0	5.0	127	254	127	2.9	39	3	M100213		
E7 or E6	300 to 350	4.0	9.0	5.0	102	229	127	1.7	23	3	M090823		
		4.0	11.8	5.0	102	300	127	1.8	24	3	M120598		
		5.0	10.0	5.0	127	254	127	1.6	21	3	M100213		
E7	400	4.0	9.0	5.0	102	229	127	2.2	29	3	M090823		
		4.0	11.8	5.0	102	300	127	2.3	31	3	M120598		
		5.0	10.0	5.0	127	254	127	2.0	27	3	M100213		
E7	457 to 460	4.0	9.0	5.0	102	229	127	3.0	41	3	M090823		
		5.0	10.0	5.0	127	254	127	2.8	38	3	M100213		
E7	310/330 & 330/355	4.0	9.0	5.0	102	229	127	1.6	22	3	M090823		
		4.0	11.8	5.0	102	300	127	1.7	24	3	M120598		
		5.0	10.0	5.0	127	254	127	1.5	21	3	M100213		
E7	355/380	4.0	9.0	5.0	102	229	127	1.9	26	3	M090823		
		4.0	11.8	5.0	102	300	127	2.0	27	3	M120598		
		5.0	10.0	5.0	127	254	127	1.8	24	3	M100213		
E6	350	3.0	11.0	4.0	76	279	102	2.4	33	1	M111029	OE replacement	

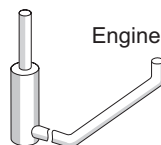

Truck Engine Muffler Application



TRUCK ENGINE APPL.

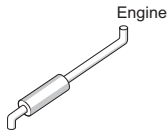

Engine Make & Exhaust System Configuration	Engine Model	H.P.	Muffler Dimensions inches			Muffler Dimensions mm			Backpressure inches of Hg		Muffler Style & Part No.	Notes			
			Inlet	Body	Outlet	Inlet	Body	Outlet	Hg	H ₂ O					
			4.0	11.0	5.0	102	279	127	2.0	27	2	M111028	Inlet dimension is OD		
			4.0	10x15	4.0	102	254x381	102	2.9	39	2	M120100	Aftermarket, shorter than OE		
			5.0	10x15	5.0	127	254x381	127	2.1	29	2	M120108	For off-hwy, shorter than OE		
			5.0	10x15	5.0	127	254x381	127	1.4	19	2	M120225	For off-hwy, shorter than OE		
			5.0	10x15	5.0	127	254x381	127	2.2	31	2	M120365	Aftermarket		
			5.0	10x15	5.0	127	254x381	127	2.3	32	2	M120448	OE replacement		
			6.0	10x15	6.0	152	254x381	152	1.2	16	2	M122300	For off-hwy, shorter than OE		
			E9	500	6.0	10x15	6.0	152	254x381	152	2.9	39	2	M122300	For off-hwy, shorter than OE
			ENDT673	225	3.0	11.0	4.0	76	279	102	1.3	17	1	M111029	OE replacement
					4.0	10.0	4.0	102	254	102	2.1	29	2	M100048	Aftermarket
4.0	11.0	4.0			102	279	102	2.1	28	2	M110012				
4.0	11.0	4.0			102	279	102	1.9	25	2	M110189	OE replacement			
4.0	11.0	5.0			102	279	127	1.1	15	2	M111028	Inlet dimension is OD			
4.0	8.3x11.5	4.0			102	211x292	102	2.1	28	2	M090280	Aftermarket, shorter than OE			
4.0	8.3x11.5	4.0			102	211x292	102	1.9	26	2	M090534	Aftermarket, shorter than OE			
4.0	10x15	4.0			102	254x381	102	1.5	21	2	M120100	Aftermarket, shorter than OE			
5.0	10x15	5.0			127	254x381	127	1.1	15	2	M120108	For off-hwy, shorter than OE			
5.0	10x15	5.0			127	254x381	127	0.7	10	2	M120225	For off-hwy, shorter than OE			
5.0	10x15	5.0			127	254x381	127	1.2	16	2	M120365	Aftermarket			
5.0	10x15	5.0			127	254x381	127	1.2	17	2	M120448	OE replacement			
6.0	10x15	6.0			152	254x381	152	0.6	8	2	M122300	For off-hwy, shorter than OE			
ENDT675	235	3.0			11.0	4.0	76	279	102	1.4	19	1	M111029	OE replacement	
		4.0			10.0	4.0	102	254	102	2.3	31	2	M100048	Aftermarket	
		4.0	11.0	4.0	102	279	102	2.2	30	2	M110012				
		4.0	11.0	4.0	102	279	102	2.0	27	2	M110189	OE replacement			
		4.0	11.0	5.0	102	279	127	1.2	16	2	M111028	Inlet dimension is OD			
		4.0	8.3x11.5	4.0	102	211x292	102	2.3	31	2	M090280	Aftermarket, shorter than OE			
		4.0	8.3x11.5	4.0	102	211x292	102	2.1	29	2	M090534	Aftermarket, shorter than OE			
		4.0	10x15	4.0	102	254x381	102	1.7	23	2	M120100	Aftermarket, shorter than OE			
		5.0	10x15	5.0	127	254x381	127	1.2	17	2	M120108	For off-hwy, shorter than OE			
		5.0	10x15	5.0	127	254x381	127	0.8	11	2	M120225	For off-hwy, shorter than OE			
		5.0	10x15	5.0	127	254x381	127	1.3	18	2	M120365	Aftermarket			
		5.0	10x15	5.0	127	254x381	127	1.4	18	2	M120448	OE replacement			
		6.0	10x15	6.0	152	254x381	152	0.7	9	2	M122300	For off-hwy, shorter than OE			
		ENDT865	325	4.0	11.0	5.0	102	279	127	2.8	38	2	M111028	Inlet dimension is OD	
				5.0	10x15	5.0	127	254x381	127	2.9	40	2	M120108	For off-hwy, shorter than OE	
5.0	10x15			5.0	127	254x381	127	1.9	26	2	M120225	For off-hwy, shorter than OE			
6.0	10x15			6.0	152	254x381	152	1.6	22	2	M122300	For off-hwy, shorter than OE			
ENDT866	375	5.0	10x15	5.0	127	254x381	127	2.3	31	2	M120225	For off-hwy, shorter than OE			
		6.0	10x15	6.0	152	254x381	152	1.9	26	2	M122300	For off-hwy, shorter than OE			
E7	300 to 350	3.0	11.0	4.0	76	279	102	1.8	24	1	M111029	OE replacement			
		4.0	10.0	4.0	102	254	102	3.0	40	2	M100048	Aftermarket			
		4.0	11.0	4.0	102	279	102	2.9	39	2	M110012				
		4.0	11.0	4.0	102	279	102	2.6	35	2	M110189	OE replacement			
		4.0	11.0	5.0	102	279	127	1.5	20	2	M111028	Inlet dimension is OD			
		4.0	8.3x11.5	4.0	102	211x292	102	2.9	39	2	M090280	Aftermarket, shorter than OE			
		4.0	8.3x11.5	4.0	102	211x292	102	2.7	37	2	M090534	Aftermarket, shorter than OE			
		4.0	10x15	4.0	102	254x381	102	2.2	29	2	M120100	Aftermarket, shorter than OE			
		5.0	10x15	5.0	127	254x381	127	1.6	22	2	M120108	For off-hwy, shorter than OE			
		5.0	10x15	5.0	127	254x381	127	1.0	14	2	M120225	For off-hwy, shorter than OE			
		5.0	10x15	5.0	127	254x381	127	1.7	23	2	M120365	Aftermarket			
		5.0	10x15	5.0	127	254x381	127	1.7	24	2	M120448	OE replacement			
		E7	400	4.0	11.0	5.0	102	279	127	1.9	26	2	M111028	Inlet dimension is OD	
				3.0	11.0	4.0	76	279	102	2.3	31	1	M111029	OE replacement	
				4.0	10x15	4.0	102	254x381	102	2.7	37	2	M120100	Aftermarket, shorter than OE	
5.0	10x15			5.0	127	254x381	127	2.0	28	2	M120108	For off-hwy, shorter than OE			
5.0	10x15			5.0	127	254x381	127	1.3	18	2	M120225	For off-hwy, shorter than OE			
5.0	10x15			5.0	127	254x381	127	2.1	29	2	M120365	Aftermarket			
5.0	10x15			5.0	127	254x381	127	2.2	30	2	M120448	OE replacement			
6.0	10x15			6.0	152	254x381	152	1.1	15	2	M122300	For off-hwy, shorter than OE			
E7	427			4.0	11.0	5.0	102	279	127	2.3	32	2	M111028	Inlet dimension is OD	
		3.0	11.0	4.0	76	279	102	2.8	38	1	M111029	OE replacement			
		5.0	10x15	5.0	127	254x381	127	2.5	33	2	M120108	For off-hwy, shorter than OE			
		5.0	10x15	5.0	127	254x381	127	1.6	22	2	M120225	For off-hwy, shorter than OE			
		5.0	10x15	5.0	127	254x381	127	2.6	35	2	M120365	Aftermarket			
		5.0	10x15	5.0	127	254x381	127	2.7	37	2	M120448	OE replacement			
		6.0	10x15	6.0	152	254x381	152	1.3	18	2	M122300	For off-hwy, shorter than OE			
E7	460	4.0	11.0	5.0	102	279	127	2.7	37	2	M111028	Inlet dimension is OD			

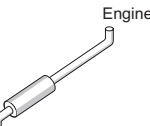
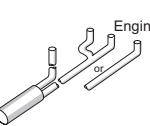
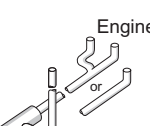
Engine Make & Exhaust System Configuration	Engine Model	H.P.	Muffler Dimensions inches			Muffler Dimensions mm			Backpressure inches of Hg / H ₂ O		Muffler Style & Part No.	Notes	
			Inlet	Body	Outlet	Inlet	Body	Outlet	Hg	H ₂ O			
	E7	310/330 & 330/355	5.0	10x15	5.0	127	254x381	127	2.8	39	2	M120108	For off-hwy, shorter than OE
			5.0	10x15	5.0	127	254x381	127	1.9	25	2	M120225	For off-hwy, shorter than OE
			6.0	10x15	6.0	152	254x381	152	1.6	21	2	M122300	For off-hwy, shorter than OE
			3.0	11.0	4.0	76	279	102	1.7	24	1	M111029	OE replacement
			4.0	10.0	4.0	102	254	102	2.9	39	2	M100048	Aftermarket
			4.0	11.0	4.0	102	279	102	2.8	38	2	M110012	
			4.0	11.0	4.0	102	279	102	2.5	34	2	M110189	OE replacement
			4.0	11.0	5.0	102	279	127	1.5	20	2	M111028	Inlet dimension is OD
			4.0	10x15	4.0	102	254x381	102	2.1	29	2	M120100	Aftermarket, shorter than OE
			4.0	8.3x11.5	4.0	102	211x292	102	2.8	38	2	M090280	Aftermarket, shorter than OE
	4.0	8.3x11.5	4.0	102	211x292	102	2.7	36	2	M090534	Aftermarket, shorter than OE		
	5.0	10x15	5.0	127	254x381	127	1.5	21	2	M120108	For off-hwy, shorter than OE		
	5.0	10x15	5.0	127	254x381	127	1.0	14	2	M120225	For off-hwy, shorter than OE		
	5.0	10x15	5.0	127	254x381	127	1.6	22	2	M120365	Aftermarket		
	5.0	10x15	5.0	127	254x381	127	1.7	23	2	M120448	OE replacement		
	E7	355/380	3.0	11.0	4.0	76	279	102	2.0	27	1	M111029	OE replacement
	4.0	11.0	4.0	102	279	102	2.9	39	2	M110028	Laminated (double) body		
	4.0	11.0	5.0	102	279	127	1.7	23	2	M111028	Inlet dimension is OD		
	4.0	10x15	4.0	102	254x381	102	2.4	33	2	M120100	Aftermarket, shorter than OE		
	5.0	10x15	5.0	127	254x381	127	1.8	24	2	M120108	For off-hwy, shorter than OE		
5.0	10x15	5.0	127	254x381	127	1.2	16	2	M120225	For off-hwy, shorter than OE			
5.0	10x15	5.0	127	254x381	127	1.9	25	2	M120365	Aftermarket			
5.0	10x15	5.0	127	254x381	127	1.9	26	2	M120448	OE replacement			
	ENDT865	325	5.0	10x15	5.0	127	254x381	127	1.9	26	5	M120131	For off-hwy, shorter than OE
	5.0	10x15	5.0	127	254x381	127	2.2	30	5	M120450	OE replacement		
	ENDT866	375	5.0	10x15	5.0	127	254x381	127	2.3	31	5	M120131	For off-hwy, shorter than OE
	5.0	10x15	5.0	127	254x381	127	2.7	36	5	M120450	OE replacement		
	E7 or E6	300 to 350	4.0	10x15	5.0	102	254x381	127	2.0	28	5	M120713	OE replacement
	5.0	10x15	5.0	127	254x381	127	1.0	14	5	M120131	For off-hwy, shorter than OE		
	5.0	10x15	5.0	127	254x381	127	2.1	28	5	M120176	Aftermarket, shorter than OE		
	5.0	10x15	5.0	127	254x381	127	2.1	28	5	M120189	Aftermarket, shorter than OE		
	5.0	10x15	5.0	127	254x381	127	1.2	17	5	M120450	OE replacement		
	E7	400	4.0	10x15	5.0	102	254x381	127	2.6	35	5	M120713	OE replacement
	5.0	10x15	5.0	127	254x381	127	1.3	18	5	M120131	For off-hwy, shorter than OE		
	5.0	10x15	5.0	127	254x381	127	2.6	36	5	M120176	Aftermarket, shorter than OE		
	5.0	10x15	5.0	127	254x381	127	2.6	36	5	M120189	Aftermarket, shorter than OE		
	5.0	10x15	5.0	127	254x381	127	1.6	21	5	M120450	OE replacement		
	E7	427 to 460	5.0	10x15	5.0	127	254x381	127	1.9	25	5	M120131	For off-hwy, shorter than OE
	5.0	10x15	5.0	127	254x381	127	2.2	30	5	M120450	OE replacement		
	E7	310/330 & 330/355	4.0	10x15	5.0	102	254x381	127	2.0	27	5	M120713	OE replacement
	5.0	10x15	5.0	127	254x381	127	1.0	14	5	M120131	For off-hwy, shorter than OE		
	5.0	10x15	5.0	127	254x381	127	2.0	27	5	M120176	Aftermarket, shorter than OE		
	5.0	10x15	5.0	127	254x381	127	2.0	27	5	M120189	Aftermarket, shorter than OE		
5.0	10x15	5.0	127	254x381	127	1.2	16	5	M120450	OE replacement			
E7	355/380	4.0	10x15	5.0	102	254x381	127	2.3	31	5	M120713	OE replacement	
5.0	10x15	5.0	127	254x381	127	1.2	16	5	M120131	For off-hwy, shorter than OE			
5.0	10x15	5.0	127	254x381	127	2.3	31	5	M120176	Aftermarket, shorter than OE			
5.0	10x15	5.0	127	254x381	127	2.3	31	5	M120189	Aftermarket, shorter than OE			
5.0	10x15	5.0	127	254x381	127	1.4	18	5	M120450	OE replacement			
	E6	350	4.0	11.0	4.0	102	279	102	3.0	40	4	M111025	Inlet & outlet dimension is OD
	5.0	11.0	5.0	127	279	127	1.9	26	4	M110014	OE replacement		
	5.0	10x15	5.0	127	254x381	127	2.0	27	4	M120366	OE replacement		
	ENDT673	225	4.0	10.0	4.0	102	254	102	2.2	30	4	M100052	
	4.0	11.0	4.0	102	279	102	1.8	24	4	M110112			
	4.0	11.0	4.0	102	279	102	1.8	24	4	M110148			
	4.0	11.0	4.0	102	279	102	1.8	24	4	M110311	Inlet dimension is OD		
	4.0	11.0	4.0	102	279	102	1.6	21	4	M111025	Inlet & outlet dimension is OD		
	4.0	10x15	4.0	102	254x381	102	2.1	29	4	M120367	Aftermarket, shorter than OE		
	5.0	11.0	5.0	127	279	127	1.0	14	4	M110014	OE replacement		
	5.0	10x15	5.0	127	254x381	127	1.1	15	4	M120366	OE replacement		
	5.0	10x15	5.0	127	254x381	127	1.7	24	4	M120417	Aftermarket, shorter than OE		
	ENDT675	235	4.0	10.0	4.0	102	254	102	2.4	32	4	M100052	
	4.0	11.0	4.0	102	279	102	1.9	26	4	M110112			
	4.0	11.0	4.0	102	279	102	1.9	26	4	M110148			

TRUCK ENGINE APPL.

Truck Engine Muffler Application

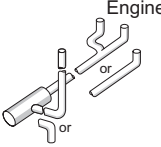
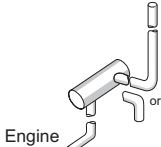
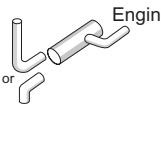

TRUCK ENGINE APPL.

Engine Make & Exhaust System Configuration	Engine Model	H.P.	Muffler Dimensions inches			Muffler Dimensions mm			Backpressure inches of Hg		Muffler Style & Part No.	Notes			
			Inlet	Body	Outlet	Inlet	Body	Outlet	Hg	H ₂ O					
	ENDT865	325	4.0	11.0	4.0	102	279	102	1.9	26	4	M110311	Inlet dimension is OD		
			4.0	11.0	4.0	102	279	102	1.7	23	4	M111025	Inlet & outlet dimension is OD		
			4.0	10x15	4.0	102	254x381	102	2.3	31	4	M120367	Aftermarket, shorter than OE		
			5.0	11.0	5.0	127	279	127	1.1	15	4	M110014	OE replacement		
			5.0	10x15	5.0	127	254x381	127	1.2	16	4	M120366	OE replacement		
			5.0	10x15	5.0	127	254x381	127	1.9	26	4	M120417	Aftermarket, shorter than OE		
			5.0	11.0	5.0	127	279	127	2.6	36	4	M110014	OE replacement		
			5.0	10x15	5.0	127	254x381	127	2.8	38	4	M120366	OE replacement		
			E7	300 to 350	4.0	10.0	4.0	102	254	102	2.7	36	4	M100052	
					4.0	11.0	4.0	102	279	102	2.2	30	4	M110112	
4.0	11.0	4.0			102	279	102	2.2	30	4	M110148				
4.0	11.0	4.0			102	279	102	2.2	30	4	M110311	Inlet dimension is OD			
4.0	11.0	4.0			102	279	102	1.9	26	4	M111025	Inlet & outlet dimension is OD			
4.0	10x15	4.0			102	254x381	102	2.6	35	4	M120367	Aftermarket, shorter than OE			
5.0	11.0	5.0			127	279	127	1.3	17	4	M110014	OE replacement			
5.0	10x15	5.0			127	254x381	127	1.3	18	4	M120366	OE replacement			
5.0	10x15	5.0			127	254x381	127	2.1	29	4	M120417	Aftermarket, shorter than OE			
	E6	350			5.0	10x15	5.0	127	254x381	127	2.1	29	6	M120418	For off-hwy, shorter than OE
	ENDT673	225	4.0	10.0	4.0	102	254	102	2.2	30	6	M100572			
			4.0	11.0	4.0	102	279	102	1.7	24	6	M111026	Outlet dimension is OD		
			5.0	10x15	5.0	127	254x381	127	1.1	15	6	M120418	For off-hwy, shorter than OE		
	ENDT675	235	4.0	10.0	4.0	102	254	102	2.4	33	6	M100572			
			4.0	11.0	4.0	102	279	102	1.9	26	6	M111026	Outlet dimension is OD		
			5.0	10x15	5.0	127	254x381	127	1.2	17	6	M120418	For off-hwy, shorter than OE		
	ENDT865	325	5.0	10x15	5.0	127	254x381	127	2.9	39	6	M120418	For off-hwy, shorter than OE		
	E7	300	4.0	10.0	4.0	102	254	102	2.7	37	6	M100572			
			4.0	11.0	4.0	102	279	102	2.1	29	6	M111026	Outlet dimension is OD		
5.0			10x15	5.0	127	254x381	127	1.4	19	6	M120418	For off-hwy, shorter than OE			
E7	350	4.0	11.0	4.0	102	279	102	2.4	33	6	M111026	Outlet dimension is OD			
		5.0	10x15	5.0	127	254x381	127	1.6	21	6	M120418	For off-hwy, shorter than OE			
	E6	350	4.0	10x15	5.0	102	254x381	127	2.4	32	3	M120566	OE replacement		
	ENDT673	225	5.0	10x15	5.0	127	254x381	127	2.6	36	3	M120235	OE replacement		
			4.0	11.0	4.0	102	279	102	2.4	32	3	M110479			
	ENDT675	235	4.0	11.0	4.0	102	279	102	2.2	30	3	M110674	Band clamp on inlet		
			4.0	11.0		102	279		2.1	29	3	M111024	Outlet has down spout		
			5.0	10x15	5.0	127	254x381	127	1.4	19	3	M120235	OE replacement		
			4.0	11.0	4.0	102	279	102	2.6	35	3	M110479			
	E7	300 to 350	4.0	11.0	4.0	102	279	102	2.4	32	3	M110674	Band clamp on inlet		
			4.0	11.0		102	279		2.3	31	3	M111024	Outlet has down spout		
			5.0	10x15	5.0	127	254x381	127	1.5	21	3	M120235	OE replacement		
			4.0	10x15	5.0	102	254x381	127	1.4	19	3	M120566	OE replacement		
			5.0	10x15	5.0	127	254x381	127	1.8	24	3	M111024	Outlet has down spout		
				5.0	10x15	5.0	127	254x381	127	2.0	27	2	M120235	OE replacement	

This catalog section contains equipment manufacturers' and competitive manufacturers' part numbers cross referenced to the Donaldson part number. The manufacturers' names are abbreviated in the catalog.

The data in this catalog is also available from our web site at www.donaldson.com. This cross reference information was compiled from available Donaldson data and should be used as a guide for choosing the proper replacement part. Check the product specifications BEFORE purchasing a part.

Manufacturers' Code Listing

Mfg. Code	Manufacturers' Name	Mfg. Code	Manufacturers' Name	Mfg. Code	Manufacturers' Name	Mfg. Code	Manufacturers' Name
AA	AMERICAN AUGERS	BATI	BENATI	COLT	COLT	EAC	ENGINE AND ACCESSORY INC
ABG	ABG	BDER	BOMBARDIER	COMP	COMPAC EQUIPMENT	EAGL	EAGLE TRUCK PRODUCTS
ABPS	AIRBORNE PRODUCT	BEQP	BELL EQUIPMENT	COMPAC	COMPACT TECHNOLOGIES	EAGP	EAGLE PICHER
AC	AC	BIAM	BUS INDUSTRIES	CONK	CONEK	EARN	EARNEST MACHINE
ACFT	ACRAFT	BLDY	BLUE BIRD BODY	COUG	COUGLAR INDUSTRIES	EATN	EATON
ACMS	ALLIS CHALMERS	BLNT	BLOUNT	CRAN	CRANE CARRIER	ECLD	EUCLID
ADUM	ADVANCE MIXER	BLWL	BLACKWELDERS	CRMY	CHAMPION ROAD	ECS	ENGINE CONTROL SYSTEMS
AECW	A E C WHITLOCK	BMY	BMY WHEELED VEHICLES	CRPD	CEDARAPIDS	EGLE	EAGLE CRUSHER
AFC	AL FILTER CO	BNTA	BANTA ASSOCIATES	CRQT	CARQUEST	EIMC	EIMCO
AGCA	ACTIVE GEAR	BOMA	BOMAG	CSND	CROSLAND	EINT	EAGLE INTERNATIONAL
AGCO	AGCO	BORG	BORG-WARNER	CTRY	CENTURY II	ELECT	ELECTROLUX
AGEM	AG CHEM EQUIPMENT		CHEMICALS	CUCC	CUB CADET	ELGN	ELGIN
AJMC	AUTO JET	BOSS	BOSS INDUSTRIES	CUMS	CUMMINS	EMOI	EMERGENCY ONE, INC.
ALMD	ALLMAND BROS	BRED	BREDA COSTRUZIONI	CYPR	CYPRESS	EMSN	EMERSON ELECTRIC
ALMN	AHLMANN	BRLEE	B R LEE INDUSTRIES	DACR	DAVEY COMPRESSOR	ENGL	ENGELHARD CORP
ALP	ALLIANCE PARTS	BROD	BRODERSON	DAEW	DAEWOO	ENGL	ENGELHARD CORP
ALSN	ALLISON	BROW	BROWN DESIGN	DART	DART	ENGN	ENGINES INC
ALSY	ALLIED SYSTEM	BRWY	BROCKWAY	DCOA	DYNAMICS CORP OF AMERICA	ENMT	ENMTP CPG
AMBC	AMBAC	BVER	BUHLER VERSATILE SERVICE	DCVG	DANA CORP	ENTW	ENTWISTLE COMPANY
AMC	AMC			DD	DETROIT DIESEL	ERIC	ERICKSON
AMEC	AM GENERAL			DENY	DENYO	ESSEX	ESSEX ELECTRO ENGES
AMERIC	AMERICAN CRANE CORP	CABT	CABOT CORP	DETX	DEUTZ		
AMFGI	AURORA MFG INC	CALD	CARRIER TRANSICOLD	DFLX	DYNAFLEX	FAS	FASTENAL
AMHO	AMERICAN HOIST & DERRICK	CAM	CAMOPLAST INDUSTRIAL	DIA	DIAMANT BOART INC	FAST	FASTENWARE
AMLF	AMERICAN LAFRANCE	CANF	CANADIAN FILTER	DINA	DINA SA	FAUN	FAUN
AMTK	AMTRAK	CASE	CASE	DIND	DIAMOND	FDEN	FODEN
AP	A P PARTS	CAT	CATERPILLAR	DLEQ	DIGITAL EQUIPMENT	FDQN	FIELD QUEEN
APE	APE INDUSTRI AB	CBM	CBM	DLTC	DRILTECH	FEDM	FEDERAL MOTORS
ARDCO	ARDCO	CC	COUNTRY COACH	DMAG	DEMAG	FEDR	FEDERAL-MOGUL
ARRO	ARROW-MASTER	CCML	CORNELL CRANES	DMI	DMI	FENT	FENDT
ARV	ARVIN	CDIV	CONTINENTAL DIVERSIFIED	DMON	DOMINION	FIAT	FIAT
AST	ASTECH UNDERGROUND	CEDAR	CEDARRAPIDS INC	DMT	DMT CORP	FILTER	FILTER SUPPLY CO
ASTECH	ASTECH	CETCO	CETCO INC	DRBG	DRONNINGBORG	FIVE	FIVE STAR MFG LLC
ASV	ASV INC	CHAMP	CHAMPION INDUSTRIES	DRDT	DROTT	FLPW	FLUID POWER
ATCO	ATLAS COPCO	CHAP	CHAMP	DREO	DIAMOND REO	FLTR	FILTER INC
ATHEY	ATHEY/FIVE STAR PRODUCTS	CHARD	CHARDONNET	DRSS	DRESSER	FLYR	FLYER INDUSTRIES
ATHM	ALSTHOM	CHLN	CHICAGO PNEUMATIC	DSL	DIESEL DIVISION	FMC	FMC
ATHP	ATHEY	CHLR	CHRYSLER	DUHR	DURHAM	FMCO	FORD
AUST	AUSTOFT	CLAC	CADILLAC & LAKE CITY ROADWAY	DWCH	DITCH WITCH	FMHD	FARMHAND
AUTM	AUTO MARINE	CLJL	CLARK, J.L.	DYPC	DYNAPAC	FMNT	FERMONT DIV
AUXI	AUXIFLOW	CLMP	CLAMPS INC.			FNEQ	FINN FILTER
		CLRK	CLARK			FOREM	FOREMOST INDUSTRIES
BABR	BARBER GREENE	CMCO	CAMECO			FPCO	FAPCO INC
BADG	BADGER	CMI	CMI			FRAM	FRAM
BAESYS	BAE SYSTEMS	CMPR	COMPAIR			FREQ	FRANKLIN
BAKO	BARKO HYDRAULICS	CMWK	CHARLES MACHINE			FRHF	FATE ROOT HEATH FASTEN
BAR	BAUER	CNLC	CURTIS NOLL			FRTL	FREIGHTLINER

Mfg. Code	Manufacturers' Name	Mfg. Code	Manufacturers' Name	Mfg. Code	Manufacturers' Name	Mfg. Code	Manufacturers' Name
RTWC.....	RAILWAY TRACK WORK	TJAK.....	TIMBERJACK	WKSA.....	WAUKESHA		
RVI.....	RENAULT VI	TJMG.....	T & J MFG	WLDN.....	WALDON		
RWMF.....	RAINBOW MFG	TKNG.....	THERMO KING	WLKR.....	WALKER MFG		
RXR.....	REXNORD	TMCO.....	TYMCO	WPOW.....	WINPOWER		
RYCO.....	RYCO	TMLS.....	TEXTRON MARINE AND LAND SYSTEM	WRNR.....	WARNER & SWASEY		
RYGO.....	RAYGO	TMPO.....	TAMPO	WRTH.....	WORTHINGTON		
RYKE.....	RYKEN TUBE	TMRK.....	TAMROCK	WSTI.....	WESTERN STAR TRUCK		
		TMTR.....	TOWMOTOR	WTLK.....	WHITLOCK		
SABI.....	SABIEX INTERNATIONAL	TORCA.....	TORCA PRODUCTS				
SAKR.....	SAKURA	TPORT.....	TUNED PORT INDUCTION SPEC	XAIR.....	EX AIR		
SAME.....	SAME	TRAK.....	TRAK INTERNATIONAL	XMN.....	EXMAN		
SCHAE.....	SCHAEFF LIFT TRUCK INC	TREX.....	TEREX				
SCNA.....	SCANIA	TRJN.....	TROJAN	YALE.....	YALE		
SCOMP.....	SUPERIOR COMPRESSOR	TRMF.....	TRANSPORTATION MFG	YOUNM.....	YOUNG MACHINE COMPANY		
SCOMPA.....	SUPERPAK COMPACTION	TRUX.....	TRUCKEX	YPEI.....	YORK PUMP & EQPT		
SCRD.....	SICARD	TYLE.....	TYLER POWER PRODUCTS				
SCRM.....	SCHRAMM	TYLR.....	TAYLOR				
SDMO.....	SDMO	TYMC.....	TAYMECH				
SDVK.....	SANDVIK						
SEDD.....	SEDDON-ATKINSON	U C.....	UNITED CENTRAL INDUSTRIAL SUPP				
S-FIRE.....	SEAGRAVE FIRE APPARATUS	UAC.....	UNITED AIR CLEANER				
SHBR.....	SCOTT HUBER	UCP.....	UNIVERSAL COACH PARTS				
SHUT.....	SHUTTLELIFT INC	UNCT.....	UNION CITY BODY				
SIGM.....	SIGMA AIR CONDITIONING	UNIP.....	UNIPART				
SISU.....	SISU	UNVL.....	UNIVERSAL				
SKYJ.....	SKYJACK	UPFR.....	UP FRONT TECHNOLOGIES				
SLAR.....	SULLAIR	UPRH.....	UP-RIGHT HARVESTER				
SLIC.....	SELLICK EQPT LTD	UPTI.....	UPTIME PARTS LLC				
SLVN.....	SULLIVAN	URIG.....	UNIT RIG EQUIPMENT				
SMCI.....	SAFARI MOTOR COACHES INC						
SNBL.....	SNOWBLAST-SICARD	VACT.....	VECTOR MFG				
SNKL.....	SNORKEL	VALM.....	VALMET				
SOFI.....	SOFIMA	VANAI.....	VANAI MFG				
SPCH.....	SPARTAN CHASSIS	VCOR.....	VERSATUBE				
SPRT.....	SPARTAN MOTORS	VENCH.....	VENCHURES PACKAGING INC				
SRC.....	SRC	VH.....	VAN HOOL				
SRSD.....	SAUER SUNDSTRAND	VIC.....	VIC				
STEW.....	STEWART & STEVENSON	VLVO.....	VOLVO				
STGR.....	STEIGER	VME.....	VME				
STIL.....	STILL	VMER.....	VERMEER				
STMC.....	STEMCO	VOEG.....	VOEGELE				
SUSN.....	SUSAN	VSTL.....	VERSATILE				
SWEE.....	SWEEPSTER JENKINS						
SYNER.....	SYNERGY INTERNATIONAL	WALMO.....	WALGAH- MOTORENTECHN				
		WBCO.....	WABCO				
TAC.....	TRANSPORTATION ACCESSORIES	WGMC.....	WHITEGMC				
TBBI.....	THOMAS BUILT BUSES	WGNR.....	WAGNER MINING EQPT				
TBCR.....	TUBE CRAFT	WHCO.....	WHITING				
TCLD.....	TRANSICOLD	WHITE.....	WHITE				
TDSC.....	TRACKMOBILE	WHMS.....	WESTINGHOUSE MFG SERVICES				
TDYN.....	TELEDYNE	WILM.....	WILMAR				
TENT.....	TENNANT	WIMC.....	WIMCO LTD				
TERN.....	TENNESS PROCUREMENT SERVICES	WIRG.....	WIRTGEN				
TESSI.....	TESSI TRUCK EXHAUST INC	WIX.....	WIX				
THOM.....	THOMAS DENNIS CO INC						
TIM.....	TIM						
TIPP.....	TIPPECANOE						

Cross Reference

(See first page of this section for Manufacturer's Code Listing)



CROSS REFERENCE

Mfgs. No.	Our No.	Mfg. Code	Mfgs. No.	Our No.	Mfg. Code	Mfgs. No.	Our No.	Mfg. Code	Mfgs. No.	Our No.	Mfg. Code	Mfgs. No.	Our No.	Mfg. Code
0														
000.....	P206309	TESSI	00642050.....	M065030	FWD	00811194.....	P206345	WALMO	0158454000.....	M001865	GILB	022066001.....	H002132	DLTC
0000001.....	M080024	MNTW	007587001.....	M120225	SDVK	00811195.....	P206347	WALMO	0158454001.....	M002135	GILB	022086001.....	M001505	DLTC
0000136929.....	M100043	CASE	007824.....	X007824	RWMF	00811196.....	P206367	WALMO	0166395.....	M085023	GRDL		M001505	SDVK
00008223.....	M085090	HAVA	008024001.....	M120131	DLTC	00811197.....	P206368	WALMO	0170019323.....	X004538	CMCO	02250158064.....	M100016	SLAR
00011101.....	M100049	DYPC		M120131	TMRK	00811198.....	P206369	WALMO	01719323.....	X004538	CMCO	02250162449.....	M090362	SLAR
00023267.....	P206407	DYPC	0080831.....	M120450	DLTC	00811199.....	P206552	WALMO	017385.....	X004482	KRES	022501642449	M090362	SLAR
00023275.....	P206409	DYPC	00810204.....	X001032	WALMO	00811200.....	P206553	WALMO	0175550004.....	X004484	WHMS	02250168659.....	M080024	SLAR
00023741.....	P208338	DYPC	00810205.....	H001033	WALMO	00811201.....	P206554	WALMO		X004484	SLVN	02250169088.....	J008681	SLAR
00035006.....	X004480	DYPC	00810206.....	H001034	WALMO	00811202.....	P206555	WALMO	01805756.....	M120598	MONAC	02250171832.....	M065139	SLAR
0009555007.....	X004538	LNDE	00810207.....	H001035	WALMO	00811203.....	P206556	WALMO	019003760008	P207408	PALA	02250183598.....	M120713	SLAR
001482001.....	P206403	DLTC	00810208.....	H001278	WALMO	00811204.....	J024836	WALMO	019012000015	P207394	PALA	02250184033.....	M090072	SLAR
001487001.....	M122300	TMRK	00810228.....	H001278	WALMO	00811205.....	J024838	WALMO	019012000017	P206323	PALA	02250186513.....	M090594	SLAR
	M122300	SDVK	00810229.....	H001279	WALMO	00811206.....	P206559	WALMO	019015690044	P206395	PALA	02250186652.....	P206304	SLAR
	M122300	DLTC	00810234.....	H001284	WALMO	00811207.....	P206600	WALMO	020002804155	P206405	VLVO	027076523.....	M085023	WGMC
0015012.....	P207335	DLTC	00810259.....	M045123	WALMO	00811208.....	P206603	WALMO	020004343116	X004478	VLVO	027076528.....	M085189	VLVO
0015013.....	P206341	DLTC	00810260.....	M045193	WALMO	00811209.....	P206608	WALMO	020004343150	P206410	VLVO		M085023	WGMC
0015017.....	P206350	DLTC	00810261.....	M045237	WALMO	00811210.....	P206610	WALMO	020004343154	X004482	VLVO	027076533.....	M090159	WGMC
0016459000.....	P206601	CUMS	00810262.....	M045193	WALMO	00811211.....	P206611	WALMO	020004362138	P206614	VLVO	027076535.....	M120197	WGMC
0019273.....	P206410	CMCO	00810263.....	M060037	WALMO	00811212.....	P206614	WALMO	020006.....	M060158	LOES	027076537.....	M100049	WGMC
00197721.....	M085023	FWD	00810268.....	M060232	WALMO	00811213.....	P207353	WALMO	0200317.....	M120598	SMCI	027076541.....	M120100	WGMC
0024008800.....	M100016	RVI	00810270.....	M060158	WALMO	00811214.....	P207364	WALMO	0201101.....	M100213	SMCI	027076542.....	M120365	VLVO
0024008900.....	P207596	RVI	00810271.....	M065065	WALMO	00811216.....	P207402	WALMO	020138.....	P270542	LOES		M120365	WGMC
00265445.....	M060037	NH	00810272.....	M065030	WALMO	00811218.....	P270531	WALMO	020147.....	M065044	LOES	027076544.....	M090074	WGMC
0028017544.....	P270535	VLVO	00810274.....	M065044	WALMO	00811219.....	P270532	WALMO	020176.....	P206405	LOES	027076545.....	M100048	WGMC
0028041569.....	P206337	VLVO	00810281.....	M070008	WALMO	00811220.....	P270533	WALMO	020183.....	M085084	LOES	027076560.....	X004480	WGMC
0028041585.....	P206408	VLVO	00810282.....	M070068	WALMO	00811221.....	P270534	WALMO	020243.....	M090158	LOES		X004480	WHITE
003056003.....	X004476	DLTC	00810283.....	M070069	WALMO	00811222.....	P270535	WALMO	020293.....	M090158	LOES	027076561.....	X004482	WSTI
003056007.....	X004482	DLTC	00810285.....	M070008	WALMO	00811223.....	P270536	WALMO	020321.....	P206544	LOES		X004482	WSTI
003056008.....	X004484	DLTC	00810287.....	M080018	WALMO	00811225.....	P270538	WALMO	020323.....	P206407	LOES		X004482	WGMC
0032941.....	X004478	CUMS	00810288.....	M080024	WALMO	00811226.....	P270539	WALMO	020332.....	H001035	LOES		X004482	WHITE
003466001.....	M120225	DLTC	00810289.....	M080018	WALMO	00811227.....	P270540	WALMO	020345.....	M060037	LOES		X004482	VLVO
004002728000	M090280	CMI	00810293.....	M085078	WALMO	00811228.....	P270541	WALMO	020390118.....	M065034	HARL	027076562.....	X004484	WSTI
004002746000	P207667	CMI	00810295.....	M085084	WALMO	00811229.....	P270542	WALMO	020395.....	P206408	LOES		X004484	WHITE
004002764000	P207667	CMI	00810297.....	M085023	WALMO	00811230.....	P270543	WALMO	020519.....	P270538	LOES		X004484	VLVO
004002768000	M120131	CMI	00810298.....	M085008	WALMO	00811683.....	X004476	WALMO	020563.....	M085208	LOES	027076626.....	X004476	WSTI
004002833000	P270535	CMI	00810300.....	M085090	WALMO	00811684.....	X004478	WALMO	020566001.....	M140048	SDVK		X004476	WHITE
004002938000	P206408	CMI	00810301.....	M085056	WALMO	00811685.....	X004480	WALMO		M140048	DLTC		X004476	WGMC
004002958000	P270538	CMI	00810304.....	M090091	WALMO	00811686.....	X004482	WALMO	020566002.....	M190002	DLTC		X004476	VLVO
004002977000	P206342	CMI	00810306.....	M090158	WALMO	00811687.....	X004484	WALMO	020570.....	M060038	LOES	027076627.....	X004478	WHITE
004003012000	M122300	CMI	00810309.....	M090535	WALMO	00811688.....	X004536	WALMO	021021.....	P206406	LOES		X004478	VLVO
004003020000	P270543	CMI	00810311.....	M090535	WALMO	00811689.....	X004537	WALMO	021022.....	P206410	LOES		X004478	WGMC
004003036000	M100213	CMI	00810313.....	M090146	WALMO	00811690.....	X004538	WALMO	021100.....	M090091	LOES		X004478	WSTI
004003064000	M120225	CMI	00810314.....	M090301	WALMO	00811691.....	X004539	WALMO	021453.....	P206409	LOES	0270825.....	X004476	HSTR
004013140000	M085207	CMI	00810315.....	M090009	WALMO	00811696.....	X004962	WALMO	021475.....	X004536	LOES		X004476	CAME
004013174000	M085207	CMI	00810318.....	M090170	WALMO	00811706.....	P207339	WALMO	021478.....	X004539	LOES		X004476	NACO
004013195000	M120418	CMI	00810319.....	M090538	WALMO	0081383318.....	P207414	CMCO	021480.....	X004478	LOES	02708250000.....	X004476	HSTR
004013216000	P206328	CMI	00810320.....	M090535	WALMO	0091327799.....	H001039	CMCO	021482.....	X004482	LOES	0270826.....	X004478	HSTR
004013287000	M170101	CMI	00810321.....	M100016	WALMO	00L02468011.....	M070008	PTBN	021483.....	X004484	LOES		X004478	NACO
004013309000	P206304	CMI	00810322.....	M100043	WALMO	010150202000	P206319	DYPC	021576.....	P270530	LOES	027136876.....	X004482	WGMC
004013311000	M090594	CMI	00810323.....	M100043	WALMO	0111379931.....	P207402	CMCO	021636.....	H001278	LOES		X004482	WHITE
004013368000	P207292	CMI	00810325.....	M100048	WALMO	0116043541.....	P270543	SAME	021673.....	P226148	LOES	027137738.....	M100464	WGMC
004013453000	M190002	CMI	00810327.....	M100213	WALMO	011781.....	P270540	LOES	021769.....	M070068	LOES	027138775.....	M100146	VLVO
004094239160	P206607	CMI	00810328.....	M100146	WALMO	0124LL1006.....	J190063	SPCH	021785.....	P270543	LOES		M100146	WGMC
004192730004	M070068	PALA	00810334.....	M120365	WALMO	01290055.....	M122300	SCRM	021835.....	P206603	LOES	0303234.....	P207415	ASV
00420920.....	M080024	FWD	00810335.....	M120225	WALMO	01290056.....	M120108	SCRM	021843.....	P270534	LOES	030495.....	M070008	KSHA
0043621341.....	H001278	VLVO	00810336.....	M120131	WALMO	013706.....	M045237	RIKL	021857.....	M080018	LOES	031005070.....	M120108	CAME
00496696.....	M090091	FWD	00810337.....	M120197	WALMO	01409T.....	M080018	NLSN	021859.....	P270532	LOES	031984001.....	P206318	DLTC
00502571.....	M085056	DYPC	00810341.....	M120176	WALMO	01522291.....	M100465	BLDY	021885.....	P270536	LOES	0323479000.....	H001034	FRTL
005191020001	M070028	PALA	00810344.....	M120365	WALMO	015226000.....	X007830	GILB	021886.....	M085078	LOES		H001034	MERS
005191360009	P270541	PALA	00810345.....	M120189	WALMO	0152826001.....	X007784	GILB	021915.....	H001279	LOES	037281.....	M070050	DRDT
005192730004	M070068	PALA	00810346.....	M120197	WALMO	0152826002.....	X007785	GILB	021919.....	H001284	LOES	03830005.....	P206603	SCRM
	M070068	SLVN	00810347.....	M120225	WALMO	0153025.....	M085056	CAME	021921.....	P270539	LOES	03830008.....	X004476	SCRM
005194700012	P206411	PALA	00810348.....	M120100	WALMO	0154799N000.....	J240003	GILB	021946.....	P206552	LOES	03830009.....	X004478	SCRM
00531742.....	M120100	FWD	00810349.....	M080018	WALMO	01552235.....	M065065	ONAN	021978.....	P270541	LOES	03861.....	P206282	DMT
00533938.....	M090544	FWD	00810352.....	M170101	WALMO	01552305.....	P206410	ONAN	021987.....	M100213	LOES	039263.....	M085008	DRDT
00538885F00.....	X004480	CONK	00810354.....	M190002	WALMO	0155304N000.....	P206552	GILB	021990.....	P226149	LOES	03B0985A0.....	P206400	JNDR
00561649.....	M100048	SCRD	00811167.....	P2										

Mfgs. No.	Our No.	Mfg. Code	Mfgs. No.	Our No.	Mfg. Code	Mfgs. No.	Our No.	Mfg. Code	Mfgs. No.	Our No.	Mfg. Code	Mfgs. No.	Our No.	Mfg. Code
0417179006	M100944	MERS	050174500006	P270532	PALA	0522291321	P207326	FOREM	057320202	M085410	CAME	0777306	M070008	RYGO
	M100944	FRTL	050174500010	P270534	PALA	0522292598	P207353	FOREM	05735409	M085078	BOMA		M070008	CAT
0417979000	M101263	MERS	050174500014	P270536	PALA	0522294388	P207341	FOREM		M085078	CAME	0779548	P206407	RYGO
0418334002	M111029	MERS	050174500020	P270539	PALA	0523282276	M120131	FOREM	05735602	P207326	CAME		P206407	CAT
	M111029	FRTL	05018750029	M090595	PALA	0523284133	P206517	FOREM		P207326	BOMA	079434	M065034	WLDN
0418814000	M111028	FRTL	05018750009	M002119	PALA	0523286128	M100213	FOREM		P207326	KOEH		M065034	MOB
	M111028	MERS	05018750011	M002118	PALA	0525091758	J000212	FOREM	05735603	P208324	BOMA	0795570C1	M120108	NAVI
0418814003	M111028	FRTL	05018750014	M002120	PALA	0525258059	P207339	FOREM		P208324	CAME	080304	M213191	LOES
	M111028	MERS	050187875	M100049	PALA	052911001	M001865	SPRT	05735604	P208326	CAME	080315	P206309	LOES
0418814007	M111025	FRTL	050187850019	M120176	PALA		M001865	SPCH		P208326	BOMA	080324	P206280	LOES
	M111025	MERS	050187850023	M100049	PALA	053117778	M085008	WGMC	057482	P270539	MOXY	080325	P206600	LOES
041889	M100048	GEHL	050187850027	M100048	PALA	0532603	M070028	ECLD	05910121	M045193	CAME	080326	P207326	LOES
0419131004	M111029	FRTL	050187850028	M085208	PALA	053394	H001039	KRES	059584	X004484	MOXY	080335	P207415	LOES
	M111029	MERS	050187850029	M090595	PALA	0536951	X004476	CONK	059617	M001432	AGEM	080341	P206403	LOES
0419131007	M111029	FRTL	050187850033	M085207	PALA		X004476	CAT	0596LL1001	P206606	SPRT	080342	P206607	LOES
	M111029	MERS	050187850035	M080018	PALA		X004476	EAGP		P206606	SPCH	080357	P206308	LOES
0422667000	M110014	MERS	050187850039	M120131	PALA		X004476	DAEW	0596LL1002	P206607	SPCH	080359	P206334	LOES
	M110014	FRTL	050187850041	M065140	KLTC	053791	X004484	FLYR	06005G	M120100	OKSH	080375	P207382	LOES
04320102	M090544	DRSS		M065140	PALA		X004484	NEWFLY	060094217	M085090	BROD	080376	P206339	LOES
	M090544	KTSU	050187850042	M085411	PALA	0538885	X004480	RYGO	060094406	M080018	BROD	080378	P206346	LOES
043405	M090538	SLAR	050187850043	M091050	PALA		X004480	MBSI	060094519	M090301	BROD	080387	P226142	LOES
04402011	M085056	SISU	0501878533	M085207	SLVN		X004480	CAT	060094529	M085409	BROD	080388	P206340	LOES
04402574	M080018	KTSU	050729403	M085080	EINT	0550019272	P206407	CMCO	060094542	P224669	BROD	080389	P206297	LOES
	M080018	SISU	0511351409	M001703	CMCO	0550019273	P206410	CMCO	060774429	X004484	BIAM	080390	P206336	LOES
044095	M085084	KSHA		M001432	CMCO	0550019275	X004482	CMCO	061514083	M085078	CLRK	080395	P206302	LOES
04450	M070028	DMON		M001503	CMCO	0550020843	P206309	CMCO	061548	J190003	AGEM	080397	P206344	LOES
044630	M070069	SLAR	0511375295	M001703	CMCO	0550038022	M070068	CMCO		J190003	LORAL	080398	P206321	LOES
044751	M090210	KSHA	05136151	M080019	DD	0550038023	M085090	CMCO	06200	X004536	VCOR	080400	P206546	LOES
045074	M070068	KSHA	051368	M100043	MOXY	0550038382	M100146	CMCO	06212	X004476	VCOR	080404	P206411	LOES
0452276	P206411	BADG	051513	X004482	MOXY	0550041602	M085056	CMCO	06214	X004537	VCOR	080405	P207667	LOES
045564	M070008	SLAR	051514	P226156	MOXY	0550046	X007831	CRAN	06231070	M065065	CLRK	080408	P226140	LOES
04710038	P206410	TMRK	051521	P206641	MOXY	0550057	P206607	CRAN	062321070	M065065	CLRK	080409	P206313	LOES
	P206410	SDVK	051522	P206543	MOXY	0550118	M002134	CRAN	06234	X004538	VCOR	080424	P207350	LOES
04710078	P206411	SDVK	051524	P206410	MOXY	0550119	M002135	CRAN	062519859	M120189	CLRK	080425	P207350	LOES
	P206411	TMRK	05179058	M090009	DD	0551306996	M090170	CMCO	062635	P207341	LORAL	080426	P207325	LOES
04710300	M100048	TMRK	05179206	M070008	DD	0551321424	P206411	CMCO	062789	J190025	LOES	080427	X004538	LOES
	M100048	SDVK	0520197	M065065	BADG	0551322079	M090072	CMCO		J190025	AGEM	080429	P206927	LOES
04710302	M120131	TMRK	0520249521	J024750	FOREM	0551326623	M090362	CMCO	062790	P207331	LORAL	080431	P207386	LOES
	M120131	SDVK	0520285021	P208394	FOREM	0551327795	M140048	CMCO		P207331	AGEM	080432	P207385	LOES
04879001	X004480	TREX	0520325	M080018	BADG	0551327796	P207341	CMCO	06300	X004478	VCOR	080434	P207326	LOES
049014270	M090544	VLVO	0520331	M090158	BADG	0551327797	P270543	CMCO	0630361	P270838	CRAN	080471	P226144	LOES
049014271	M090544	VLVO	0520340	M100048	BADG	0551327798	P206556	CMCO	0630895	P270541	CRAN	080477	P207351	LOES
049014272	M100464	VLVO	0520371	M120100	BADG	0551331975	P207366	CMCO	06312	X004480	VCOR	080479	J024836	LOES
049014273	M090544	VLVO	0520372	M120225	BADG	0551331976	X004539	CMCO	0631911	P270543	CRAN	080480	P206602	LOES
049015280	M100464	VLVO	0520379	M085023	BADG	0551339700	P206344	CMCO	063676064	X004478	CLRK	080481	X007784	LOES
049033350	M090535	WGMC	0520379	M085023	BADG	0551346685	M120225	CMCO	06400	X004482	VCOR	080482	P206612	LOES
049034037	M120131	WGMC	052179	P206603	NEWFLY	0551356249	P226158	CMCO	06444	X007784	VCOR	080483	P206604	LOES
	M120131	WSTI		P206603	FLYR	0551368096	M120131	CMCO	0644LL1001	M170101	SPRT	080488	P206334	LOES
049034554	M090535	WGMC	0522005282	P206405	FOREM	0551369882	P206547	CMCO	06500	X004484	VCOR	080490	P206331	LOES
049039300	M090535	VLVO	0522052132	P207324	FOREM	0551389997	J008681	CMCO	06555	X007785	VCOR	0815014	P270534	CAT
	M090535	WGMC	0522053864	P206407	FOREM	0551390004	P206374	CMCO	06600	X004539	VCOR	0816406	X004484	CAT
049039304	M120365	WGMC	0522054178	J009486	FOREM	0551390009	P208366	CMCO	067496	M060158	WLDN	0816407	X004478	CAT
	M120365	VLVO	0522126985	J009487	FOREM	0551391960	P206552	CMCO		M060158	MOB	081789	P208385	GNRC
049039307	M120189	WSTI	0522184276	P206397	FOREM	0551392182	P206346	CMCO	067819	J009648	FLYR	0818035	M120131	RYGO
	M120189	VLVO	0522255178	J009624	FOREM	0551392616	P206525	CMCO		J009648	NEWFLY		M120131	CAT
049044073	M100465	VLVO	0522258089	P207339	FOREM	0551392617	P206543	CMCO	0680009	M060005	NAVI	0819056	M090301	BABR
049044343	M100463	VLVO	0522259555	P206324	FOREM	0551392618	P206508	CMCO	0680015	M090009	NAVI		M090301	CAT
049045022	M100465	VLVO	0522260136	P207584	FOREM	0551394610	P206540	CMCO	06973	M090009	DMON		M090301	RYGO
049045722	X007784	WSTI	0522262510	P207331	FOREM	0551394657	P206511	CMCO	0700715572	J240004	AGCO	0823452	M085208	EIMC
049045723	X007785	WSTI	0522264637	P207326	FOREM	05519272	P206407	CMCO	0700716743	P206552	AGCO	083816	M060055	MOB
049045724	X004478	WSTI		P207329	FOREM	05519273	P206410	CMCO	07024938	P206410	DETZ		M060055	WLDN
049045727	X004482	WSTI	0522266576	P207349	FOREM	05519274	X004478	CMCO		P206410	AGCO	085058	P207330	GNRC
049046709	X004484	WSTI		P270543	FOREM	05519275	X004482	CMCO	072380	P206347	SWEE	0851375286	H001034	CMCO
049047016	M100464	VLVO	0522268168	P207349	FOREM	05520843	P206309	CMCO	0724132	M120100	GRVE	0868829	M091046	LETO
049660	X004478	SLAR	0522269207	P207322	FOREM	05538022	M070068	CMCO	0770460000	M060055	PTBN	089275	X004482	NEWFLY
049787	X004476	SLAR	0522271102	P207351	FOREM	05538023	M085090	CMCO	0773465	M085056	CAT	09013928	M120108	TREX
050170900009	M065030	PALA	0522276826	P226147	FOREM	05538382	M100146	CMCO	0773905	M090170	RYGO	0906031007	M100146	TREX
	M065030	SLVN	0522280285	P207359	FOREM	05541602	M085056	CMCO		M090170	CAT	0906040713	J009606	TREX
050170900010	M070069	PALA	0522283780	J009623	FOREM	056005	M090544	PACC	0775683	M090074	CAT	0906040715	P206364	TREX
050170900012	M100016	SLVN	0522284743	J190055	FOREM	0561649	M100048	PACC		M090074	RYGO	09079368	M170101	TREX
	M100016	PALA	0522285082	P207402	FOREM	0561819	M080018	SCRD	0776921	M090158	RYGO			

Cross Reference

(See first page of this section for Manufacturer's Code Listing)



CROSS REFERENCE

Mfgs. No.	Our No.	Mfg. Code	Mfgs. No.	Our No.	Mfg. Code	Mfgs. No.	Our No.	Mfg. Code	Mfgs. No.	Our No.	Mfg. Code	Mfgs. No.	Our No.	Mfg. Code
0937019	J000209	CAME	10002040	P206337	BLNT	1008681	P206508	Marine	10310	P206350	TRUX	1055295	M100463	AMHO
09385100	P206328	KRON		P206337	CAT	100870	P206411	AGEM	1031049	X004480	ELGN	10553	P207338	TRUX
09385630	P206605	KRON		P206337	COLT	1009109	J000206	Marine	1031066	P206409	ELGN	10554	P206347	TRUX
09385660	P207582	KRON	10002043	P206309	HDMA	1009187	J000205	Marine	1031067	P206410	ELGN	10555	P207340	TRUX
09385690	X006203	KRON	10002214	M045237	SCRD	1009243	M090538	TDSC	1031068	P206507	ELGN	10556	P207341	TRUX
09386890	X006202	KRON	1000269	X004482	URIG	1009244	P206327	TDSC	10312	P206279	TRUX		P207341	GOE
09386900	P208374	KRON	1000270	X004484	URIG	1009526	P206850	Marine	10313	P206280	TRUX	10557	P207339	TRUX
09386910	J190003	KRON	1000384	M002164	BADG	1010136	M090538	TDSC	10314	P206281	TRUX	10559	P207354	TRUX
09386920	X004478	KRON	1000389	M120108	CUMS	101085302A	M085008	GRST	10315	P206282	TRUX	105596A	X007805	OKSH
09401290	P207394	KRON		M120108	URIG	10114310	P206333	BOSS	10317	P206283	TRUX	10560	J009560	TRUX
09401300	P206318	KRON	100043	M100043	PDCI	1011592	M060232	GRST	1032550	M065030	GRST	10562	P207347	TRUX
09401310	X004539	KRON	10004693	P206326	BLNT		M060232	HRCN	10329	J190014	TRUX	10564	P207354	TRUX
0944128	X004478	TREX		P206326	CAT	10116406	P206851	HRCN	10330	P207361	TRUX	10565	P207352	TRUX
	X004478	OK	100052	M100052	VSTI	1012004B	P207415	GRDL	10337	P206397	TRUX	10566	P207353	TRUX
09673152	M001702	BVER	10008	M100466	RKRM	10135094	M065044	OMNI	10338	P206398	TRUX	10567	P207354	TRUX
0970432484	P207355	CEDAR	10008012	P270538	BLNT		M065044	JLGI	10339	P206399	TRUX	1059203	P207354	TDSC
097470	M120154	DRDT		P270538	CAT	1015551	M120108	TDSC	10340	P206400	TRUX	1059205	X004480	TDSC
0980240	M085090	RYGO	10008318	P206334	CAT	1017391	M085078	ELGN	1034001282	X004482	FAS	1059997	M070028	TDSC
0A6290	M101170	GEHL	10008343	P270541	BLNT	10175432	M070008	FWD	1034633	M060055	ELGN	1060	P206338	XAIR
	M101170	GNRC		P270541	OMML	10175510	M090544	FWD	1034635	X004536	ELGN	10600	P206338	HDMI
0D5745	P210110	GNRC		P270541	CAT	10175576	M085008	FWD	1034636	P206403	ELGN		P207340	DFLX
0D6667R	P206615	GEHL	10008352	P206411	OMML	10175581	M090074	FWD	1034712	P207364	GRST	1060073	P206325	TDSC
	P206615	GNRC		P206411	BLNT	10175617	M090544	FWD	1034713	P270532	ELGN	1060074	P206363	TDSC
0D8473	M085090	GNRC		P206411	CAT	10175623	M070028	FWD	1035	P206335	XAIR	10600A	P206338	HDMI
0D9906B	P207584	GNRC	1000882	M091048	BADG	10175624	M090146	FWD	10350	P206342	DFLX	1060213	P207363	TDSC
0E4264	J000228	GNRC	1000883	M002120	BADG	101865	M120100	KTSU		P206335	HDMI	1060909	M080024	TDSC
0E5955	M070068	GNRC	10009625	P206333	BLNT		M120100	DRSS	1035000247	M090091	FAS	1061246	P206320	TDSC
0F0904	M090091	GNRC		P206333	CAT	101877	M100048	TRSU	1035000248	P206511	FAS	10620	P206344	TRUX
0L102468017	M070069	PTBN	10009862	M100463	SPCH		M100048	KTSU	1035000322	X004484	FAS	10626452	J000203	DSL
0L102468019	M070069	PTBN		M100463	SPRT	1018783	X004478	ELGN	1035000323	X004482	FAS		J000203	GDLS
0LA00124007	P270538	PTBN	1001080429	P206306	JLGI	10190018	P206331	BOSS	1035000328	M100463	FAS	106275	M085172	ARV
0LA00998016	P206344	PTBN		P226152	JLGI	1020	P206331	XAIR	1035000790	P206385	FAS	10631	J009631	TRUX
0LA01145000	M080024	PTBN	1001080490	P207317	PIE	10200	J008671	DFLX	10350A	P206335	HDMI	10632	J009632	TRUX
0NG18020	P206367	AA	10020	M100465	RKRM	10200AZ	J008671	DFLX	10350AZ	P206342	DFLX	10633	J009633	TRUX
0RO17765000	M070008	PTBN	10021	M100807	RKRM	1020997	M090091	TDSC	1035924	M120365	URIG	10635	J009635	TRUX
0RO17765000	M070008	PTBN	10023	M100466	RKRM	1021711	M120100	GRST	1036008	M190002	URIG	10636	J009636	TRUX
0RO23180028	M085023	PTBN	10023028	M080018	BLNT	1025	P206333	XAIR	1036808	M065044	GRST	10637	J009637	TRUX
0RO23180037	M085008	PTBN		M080018	CAT	10250	P206339	DFLX	1036983	P206327	ELGN	10639	J009639	TRUX
0RO23180065	M070069	PTBN	10023109	P206544	BLNT	10253	M080024	CRMY	1040	P206336	XAIR	10640	J009640	TRUX
0RO23180076	M085090	PTBN		P206544	CAT		M080024	DMON	10400	P206336	HDMI	10641	J009641	TRUX
0RO23180090	M100048	PTBN	10024	M100048	RKRM	1026178	M100146	GRST	10400A	P206336	HDMI	10644	J009644	TRUX
			10028	M100465	RKRM	1026921A	J190042	GRDL	10400AZ	P206344	DFLX	10645	J009645	TRUX
			10029	M100463	RKRM	1026921B	P206339	GRDL	10400CP	P207345	DFLX	1065376	P224710	ELGN
			1003146	M070068	Marine	1026921E	P207349	GRDL	104128	M085023	MJPR	106591	X004539	EIMC
				M070068	GRVE	1026921F	P207397	GRDL	1042175	M090091	TIM	10671	J008671	TRUX
				M070068	SHUT	102732	M110012	ARV	1047721	M080024	AMHO	10672	P206339	TRUX
				M070068	MTWC	10275	P216172	DFLX	104851A	X004478	OKSH	10674	P216172	TRUX
			1000009	P207322	MTWC	10275AZ	P216172	DFLX	104852A	X004482	OKSH	10675	P206340	TRUX
				P207322	GRVE	1027Z225	M090074	PH	1050	P206337	XAIR	10676	P206342	TRUX
			1000012	P206331	MTWC	102838	M090538	ARV	10500	P206337	HDMI	1067766	P226143	AMHO
				P206331	GRVE	102894	M090280	ARV	10500A	P206337	HDMI	1067767	P206338	Americ
			10000468	M100463	CUMS	102895	M090563	ARV	10500CP	P207346	DFLX	10678	P206344	TRUX
			10000494	M120418	CUMS	102902	M090534	ARV	10501390	J000206	CAT	10680	P207339	TRUX
			10000499	P206521	CUMS	102905	P270531	Marine		J000206	BLNT	10681	J008681	TRUX
			10000520	M085411	CUMS	102969	M085267	ARV	1050221	M100464	VSTI	10683	P206394	TRUX
			10000521	M091050	CUMS	102974	M090520	ARV	1051350	M001756	CMWK	10684	P206395	TRUX
			10000541	M100572	CUMS	102BB16	P206411	SPRT	1051535	P206544	GEHL	10685	P206396	TRUX
			10000557	M120225	CUMS	1030	P206334	XAIR	105211	P206324	AP		P206396	GOE
			10000627	M060251	CUMS	10300	P206342	DFLX	10534	P207326	TRUX	1069179	P206322	TDSC
			10000628	M065074	CUMS	103009	P206334	HDMI	1053578	M070069	FREQ	1069203	P207282	TDSC
			10000641	M100572	CUMS	103021	M090547	ARV	10537	P207328	TRUX	1069206	X004482	EIMC
			10000644	M090598	CUMS	103022	M120154	ARV	10538	P207329	TRUX	106B4943	M085023	EIMC
			10000819	P207667	CAT	10303	P207335	TRUX	10539	P207330	TRUX	1070735	X004482	Americ
				P207667	BLNT	10304	P206341	TRUX	10540	P206346	TRUX	107113	P206301	Marine
			10000880	M120108	CUMS	10305	P206343	TRUX	10541	P207331	TRUX	10719262	M085078	OMNI
			10000881	M120235	CUMS	10306	P206345	TRUX	10542	P207332	TRUX	10719871	M060158	LULL
			10001143	H001034	CUMS	10308	P206348	TRUX	10544	P206349	TRUX		M060158	JLGI
			10001352	M065044	HDMA	10309	P206349	TRUX		P206301	CHAMP	1072037	P206366	ELGN
			1000146	M101169	BADG					P206301	CRMY	10724	P206339	AP
			1000147	M002121	BADG								P206339	GOE
			1000164	H001034	BADG							1072425	P206369	TDSC
			10002039	P206337	CAT							10725	P206368	AP
				P206337	BLNT							10726	P206282	TRUX
			1000204	M080018	TDSC									

Mfgs. No.	Our No.	Mfg. Code	Mfgs. No.	Our No.	Mfg. Code	Mfgs. No.	Our No.	Mfg. Code	Mfgs. No.	Our No.	Mfg. Code	Mfgs. No.	Our No.	Mfg. Code
1072696	J008671	ELGN	10837799	M065073	LULL	10PL400AZ	P207329	DFLX	111138A	M001432	CMWK			
10727	J190023	TRUX		M065073	JLGI	10PL500	P206349	DFLX	11127	M090538	PDCI	114656200	M065074	CAM
10728	P206282	TRUX	1087288	P226145	ELGN	10PL500AZ	P206349	DFLX	1113731	P206543	GEFCO		M065074	PRIN
10728181	P270539	JLGI	1087289	X007831	ELGN	10PL600AZ	P216175	DFLX	11137351	M090509	OKSH	114661200	M002118	CAM
10729	J190025	TRUX	1087292	P206363	ELGN	10T30015	P206393	DFLX	1114702	P222750	GEFCO		M002118	PRIN
1072980	J009648	ELGN	108818620	P206603	PRIN	10T30090	P206397	DFLX	1114917	M100463	VLVO	114666460	M120749	PRIN
10730	J190025	TRUX	108935H45	M085056	DRSS	10T35015	P206394	DFLX	1116418	M090091	OKSH	114666469	M002123	CAM
10731	P206283	TRUX		M085056	KTSU	10T35030	J009635	DFLX	111641B	M090091	OKSH		M002123	PRIN
10732	J190027	TRUX	108936	M100048	DMI	10T35090	P206398	DFLX	11165	M100463	PDCI	114666604	P207298	CAM
10741	P207350	TRUX		M100048	KTSU	10T40015	P206395	DFLX	1116639	M100213	VLVO		P207298	PRIN
10742	P207351	TRUX	1089600051	P205976	FAS	10T40030	J009635	DFLX	11172962	J190061	VLVO	114666634	P206323	PRIN
1074277	P207364	ELGN	1089600052	P205979	FAS	10T40060	J009644	DFLX	1119466	X006203	VLVO		M065034	CAM
1074283	J009618	ELGN	1089600169	X004962	FAS	10T40090	P206399	DFLX	11197	M122300	PDCI	114666743	M065034	CAM
10743	P207353	TRUX	1089600300	P270540	FAS	10T50015	P206396	DFLX	1120408	P270536	JLGI		M065140	CAM
10744	P207353	TRUX	1089600675	X007785	FAS	10T50030	J009637	DFLX	1120421	P206399	GEFCO		M065034	PRIN
10745	P207353	TRUX	1089600676	M001668	FAS	10T50060	J009645	DFLX	1120471	P207582	GEFCO	114666796	M085407	CAM
10746	P207354	TRUX	1089600677	X007784	FAS	10T50090	P206400	DFLX	1120481	P206349	GEFCO		M085407	PRIN
10748	P207355	TRUX	1089600678	M001503	FAS	10T60090	P207366	DFLX	1120482	P207326	GEFCO	11466693744	M085421	CAM
10749	P207355	TRUX	1089601305	J000209	FAS	10UH2	P206519	ACFT	1120581	P206340	GEFCO		M085421	PRIN
1075321	P270534	ELGN	108973	M120365	FMC	1100010	M060055	Marine	11209	M170101	PHCO	114667017	M002117	CAM
10755	J009560	AP	108980	P206409	FMC		M060055	CASE	11223	M085172	HDMI		M002117	PRIN
1075550004	X004484	WHMS	108982	P206411	FMC		M060055	SHUT	11224	M100465	PDCI	114667082	M002119	PRIN
10756	P206340	TRUX	10908	M100464	RKRM	11000419	M002119	CUMS	11227	M090520	PDCI	114667539	M085208	PRIN
10758	P206341	TRUX	10915	M100048	RKRM	11000420	M002120	CUMS	112273	X004484	AMTK	114667565	J000200	PRIN
1075836	M001702	ELGN	10918	M100043	RKRM	11000475	M002117	CUMS		X004484	AUTM	11500	P207339	DFLX
10759	P206342	TRUX	109185A1	M001756	MCC	11000476	M002118	CUMS	11228	M090544	JHEI	1150045	P206283	HDMI
10761	P206344	TRUX		M001756	PTN	11000487	P206325	CUMS		M090544	PDCI	1150045A	P206283	HDMI
1076118	P206362	ELGN		M001756	CASE	11000488	P206520	CUMS	112351	M085056	FXBL	11500AZ	P207339	DFLX
107619001	X004482	VMER	10920	M100463	RKRM	11000509	M002121	CUMS	112352	M120100	FXBL	11518	P207283	XAIR
1076190011	X004482	VMER	10921	P206306	AP	1100054	P206344	TIPP	1130045	P206280	HDMI	1151918	M120131	Americ
107619003	X004480	VMER	10922	M100807	RKRM	11000880	M002123	CUMS	1130045A	P206280	HDMI		M120131	AMHO
1076190031	X004480	VMER	10925	M101169	NH	1100101	P206340	TIPP	11335	J000221	NH	11524	J024739	XAIR
10762	P206345	TRUX	1092788	P207281	BABR	1100279	M085023	TIPP	11336	M065142	NH	11536	P208380	XAIR
10763	J190002	TRUX	10928	M100582	RKRM	1100382	P206345	TIPP	11337	M002118	NH	11548	P207292	XAIR
	P206345	GOE	10929	P206311	NH	1100440	X004478	OMNI	11338	P206301	NH	11550045	J190025	HDMI
10764	J190003	TRUX	10930	M100052	RKRM		X004478	JLGI	1135045	P206281	HDMI	1155262	M100464	AMHO
10765	P206347	TRUX	10931	M100049	RKRM	1100689	M070028	TIPP	1135045A	P206281	HDMI	11560	P207289	XAIR
10766	P206348	TRUX	10932	M100572	RKRM	11008	J000231	NH	113536	P208348	XAIR	115841	M120176	KRES
10767	P207341	TRUX	10945	M100695	RKRM	110105	P206340	TIPP	11382	J000233	TMCO	1160045	P207359	HDMI
	P207364	GOE	10961	M100213	RKRM	11015	M085023	HDMI	11400	P207596	TMCO	1160045A	P207359	HDMI
1077286	P216174	ELGN	1097987	X004476	CAT	11019	M085080	PRVT	1140045	P206282	HDMI	116370001	M085090	VMER
10773	P207322	TRUX		X004476	TIM	110219	P206326	TIPP	1140045A	P206282	HDMI	1163700011	M085090	VMER
10774	P207324	TRUX	1097LL2001	M120131	SPRT	11023	M090535	PDCI	114008	P207366	AUTM	116949	P206410	EIMC
10775	P207325	TRUX	109820B	M100465	OKSH		M090535	FRAM	114014	P207332	AUTM	117544	M120225	WIRG
10776	P207362	TRUX	10L200	P207333	DFLX		M090535	ALSY	114111300	M080024	BDER	118073	P270536	ME
10777	P207362	TRUX	10L250	P207335	DFLX	1102LL2001	M120225	SPRT	114143800	M085084	BDER	118359	P208326	CHAMP
10778	J190013	TRUX	10L300	P206341	DFLX	11035	M120365	PHCO	114144400	M090210	BDER	11850495	M001756	VLVO
107789B	M100465	OKSH	10L300AZ	P206341	DFLX	11038	M080018	YPEI	11415068	P206552	VLVO	1185900	M120108	TREX
10780	P207364	TRUX	10L350	P206343	DFLX		M080018	PKNS	11415070	M002121	VLVO		M120108	OK
1078066	P206370	ELGN	10L350AZ	P206343	DFLX	11058	M002121	NH	11415098	P206321	VLVO	11870553	M001702	VLVO
10781	P207364	TRUX	10L400	P206345	DFLX	11068196	P207394	ECLD	11415101	M001503	VLVO	11872	M100464	CRMY
10782	J190009	TRUX	10L400AZ	P206345	DFLX	11075	M045193	HDMI	11415189	M001702	VLVO	11873	M100464	CRMY
10783	P206346	TRUX	10L400CP	P206353	DFLX	11076	M065071	YPEI	11415198	M002119	VLVO	11875	M090170	CRMY
1078581	M120135	TDSC	10L500	P206348	DFLX	11096	M085171	PDCI	11415205	J190009	VLVO	11876	M090158	DMON
1078582	P206521	TDSC	10L500AZ	P206348	DFLX	110H070120	P206602	WSTI	11415206	J009648	VLVO		M090158	CRMY
10786	P207365	TRUX	10L500CP	P206354	DFLX	11101	M100049	TMPO	11415207	M085208	VLVO	11877	M100043	CRMY
10787	P207365	TRUX	10L600	P206350	DFLX	1110389	M090210	BABR	11415208	P206544	VLVO	1189A01G01	X004536	TKNG
10789	P207365	TRUX	10L600AZ	P206350	DFLX	11104	M085056	PKNS	11415273	P206326	VLVO	11901	M110189	RKRM
10790	P207332	TRUX	10P225AZ	P216174	DFLX	1111110	M100465	UPTI	11415373	M002118	VLVO	11908	M045237	WILM
10791	P207365	TRUX	10P300	P207326	DFLX		M100465	VLVO	11418	P207282	XAIR	119242	P206347	EIMC
10792	P207366	TRUX	10P350	J190014	DFLX	1111111	M090544	VLVO	114212	M065030	CHAMP	119353	P207354	CHAMP
	P207366	GOE	10P350AZ	P207327	DFLX	1111112	M090535	VLVO		M065030	CRMY	11A30045	P207351	HDMI
	P207366	AP	10P400AZ	P206346	DFLX	1111114	M100464	VLVO	11424	J024737	XAIR	11A30045A	P207351	HDMI
10794	P207363	TRUX	10P500	P207331	DFLX	11112	M090009	LCD	114271	M085023	TMLS	11A35030	J009635	HDMI
10796	P207331	TRUX	10P600	P216175	DFLX	111122	P270536	CMWK	114289	M090170	DRSS	11A35030A	J009635	HDMI
10797	P207329	TRUX	10PL200	P207322	DFLX	111122A	P270536	CMWK	114338	M085023	KTSU	11A40015	P206395	HDMI
1079866	P206344	ELGN	10PL225	P216174	DFLX	111123	P270543	CMWK		M085023	DRSS	11A40015A	P206395	HDMI
108019	P206411	DRSS	10PL250	P207324	DFLX	111130	P206603	CMWK	11436	P208364	XAIR	11A40030	J009636	HDMI
	P206411	KTSU	10PL300	P207326	DFLX	111136	P206512	CMWK	11448	P207287	XAIR	11A40030A	J009636	HDMI
1081770	M001593	CAT	10PL350	P207328	DFLX	111136A	P206512	CMWK	114646800	M065044	CAM	11A40045	P207353	HDMI
			10PL350AZ	P207328	DFLX	111137A	M002121	CMWK		M065044	BDER	11A40045A	P207353	HDMI
			10PL400	P207329	DFLX	111138	M001432	CMWK	11464680044	M065044	PRIN	11A50015	P206396	HDMI

Cross Reference

(See first page of this section for Manufacturer's Code Listing)



CROSS REFERENCE

Mfgs. No.	Our No.	Mfg. Code	Mfgs. No.	Our No.	Mfg. Code	Mfgs. No.	Our No.	Mfg. Code	Mfgs. No.	Our No.	Mfg. Code	Mfgs. No.	Our No.	Mfg. Code
11A50015A	P206396	HDMI	12266600	J190020	HRCN	12408880	M120225	CAT	125158	M001702	AGEM	12969930	M090538	VLVO
11A50030	J009637	HDMI	12266659	P207354	HRCN	124089	P206409	KOEH	125159	M085409	AGEM		M090538	ECLD
11A50030A	J009637	HDMI	12266744	X007785	GRST	12410	P206344	HDMI	125160	P206544	AGEM	12998713500	M065074	NEWS
11L200	J008671	DFLX	122707	P208394	AGEM	12410A	P206344	HDMI	125161	P206380	AGCO	12998713530	P270535	NEWS
11L275	P216172	DFLX	12275	P207350	DFLX	12414634	P206606	LINMR		P206380	AGEM	12998713540	P206405	NEWS
11L300	P206340	DFLX	12275AZ	P207350	DFLX		P206606	STEW	12518	P207298	XAIR	12A300	P207352	HDMI
11L400	J008681	DFLX	122807	M100465	COLT		P206606	OKSH	12524	J024747	XAIR	12A300A	P207352	HDMI
11L500	P207339	DFLX	122939	M001327	COLT		P206606	AMEC	12548	P207296	XAIR	12A300	J190013	HDMI
11M830040	X004536	HYUN	12300	P206280	DFLX	12418	P207297	XAIR	12549	M045193	TMCO	12A330A	J190013	HDMI
11ME228	X007831	MACK		P206341	HDMI	12421711	M120100	GRST	1256106	M080024	KOEH	12A350	P207327	HDMI
11ME229	X004480	MACK	12300A	P206341	HDMI		M120100	HRCN	12562	X004482	FLYR	12A350A	P207327	HDMI
11ME348M	M001865	MACK	12300F	P206341	HDMI	12424	P207297	XAIR	125625	M085008	KOEH	12A350F	P207363	HDMI
11P300	P207362	DFLX	12300FA	P206341	HDMI	12427178	M100146	HRCN	125626	P206407	KOEH	12A350FA	P207363	HDMI
11P300AZ	P207362	DFLX	12300FS	P206341	HDMI		M100146	GRST	125648	M065034	KOEH	12A3513	M100464	FMC
11P300AZ	P206398	DFLX	12300FSA	P206341	HDMI	1242847	M045123	GRST	125653	M065065	KOEH	12A3569	M090146	FMC
11P400	P207364	DFLX	123137	M120100	COLT	12428471	M120100	GRST	125656	M100048	KOEH	12A400	P206346	HDMI
11P400AZ	P207364	DFLX	12322837	M060232	GM		M045123	HRCN	125657	M070069	KOEH	12A400A	P206346	HDMI
11P500	P207365	DFLX	12322838	M065065	GM	124312241	M090594	FURU	125658	M090544	KOEH	12A440	P207364	HDMI
11P500AZ	P207365	DFLX	12322841	M085172	GM	1243122H1	M090594	CETCO	125666	M100464	KOEH	12A440A	P207364	HDMI
11P600	P207366	DFLX	12322842	M085171	GM		M090594	KTSU	125668	M085078	KOEH	12A550	P207365	HDMI
11PL350AZ	P207363	DFLX	12322844	M085023	GM		M090594	DRSS	125669	M090091	KOEH	12A550A	P207365	HDMI
11PL400	P206346	DFLX	12322845	M085189	GM	1243226H1	M070068	DRSS	125670	M085023	KOEH	12A555	P207332	HDMI
11PL500	P207332	DFLX	12322846	M090534	GM		M070068	KTSU	125672	M100048	TREX	12A555A	P207332	HDMI
11PL500AZ	P207332	DFLX	12322847	M090535	GM		M070068	KTSU	125675	M100463	KOEH	12B300	J190013	HDMI
11S50045	J190025	HDMI	12322848	M100464	GM	1243327H1	M085090	KTSU	125684	M090158	KOEH	12B300A	J190013	HDMI
11S50045A	J190025	HDMI		M100464	ALSN		M085090	DRSS		M090158	TREX	12B300F	J190013	HDMI
11S50045CP	P206286	HDMI	12322849	M090538	GM	12436	P208366	XAIR	125695	M085090	KOEH	12B300FA	J190013	HDMI
11T30015	P206393	DFLX	12322850	M090544	GM	12440471	M090091	PTN	12574828	P207596	ECLD	12B350	P207328	HDMI
11T30090	P206397	DFLX	12322851	M090781	GM		M090091	CASE	12583808	X004538	ECLD	12B350A	P207328	HDMI
11T35015	P206394	DFLX	12322852	M090547	GM	12448	P207295	XAIR	12584634	M140048	ECLD	12B350F	P207327	HDMI
11T35090	P206398	DFLX	12322853	M090548	GM	12450F	J190002	HDMI	125925	M090210	KTSU	12B400	P207329	HDMI
11T400	P206399	DFLX	12322854	M090563	GM	12450FA	J190002	HDMI		M090210	DRSS	12B400A	P207329	HDMI
11T40015	P206395	DFLX	12322855	M100463	GM	12462838	M065030	HRCN	12600	P206350	HDMI	12B400CP	J190016	HDMI
11T40090	P206399	DFLX	12322856	M100464	GM	12464413	M085056	SCOMP	12600A	P206350	HDMI	12B400F	P206346	HDMI
11T500	P206396	DFLX	12322857	M100465	GM		M085056	HRCN	12600CP	P207359	DFLX	12B400FA	P206346	HDMI
11T50015	P206396	DFLX	12322858	M100466	ALSN		M085056	GRST	12615933	X004962	ECLD	12B500	P206349	HDMI
11T50090	P206400	DFLX		M100466	GM	12465589	M065034	BOSS	126170	M065065	KTSU	12B500A	P206349	HDMI
11T600	P207361	DFLX	12322859	M110012	GM		M065034	SCOMP	126174	X004482	IRT	12B500F	P207331	HDMI
11T60090	P206361	DFLX	12322860	M110014	GM		M065034	HRCN	1261996	M101181	PIE	12B500FA	P207331	HDMI
1200	P207333	XAIR	12322861	M120365	GM		M065034	GRST	126417	M060158	TMPO	12B500FCP	J190019	HDMI
12000277	P270539	PERK	12322864	M120366	GM	12465802	M060037	SCOMP	126501	M002123	AGEM	12H0020	M085023	LKBT
12006	M080024	PWRT	12322865	M120367	ALSN		M060037	BOSS	126558	M001668	AGEM		M085023	FMC
12010	M080024	PETTI	12322867	M120382	GM		M060037	GRST	1265974H1	P206410	FURU	12H0411	J009514	LKBT
120167A	M100043	OKSH	12336	P208326	XAIR		M060037	HRCN		P206410	DRSS	12H20	M070008	FMC
12021898	P206326	BOSS	1234	M001756	FLPW	12466144	M065073	GRST	12680001	X004536	STMC	12K14764LA	J038611	HDMI
12022083	P207362	HRCN	1234226H1	M070068	DRSS	12468776	M085189	HRCN	12680002	X004537	STMC	12K14764RA	J038612	HDMI
12024	M090072	PDCI		M070068	KTSU	12470463	M080024	HRCN	12680003	X004476	STMC	12K5419A	J018110	HDMI
12027435	P207361	GRST	12350	P206281	HDMI	12470842	M065073	HRCN	12680004	X004538	STMC	12L275	P207350	DFLX
	P207361	HRCN		P206281	DFLX	12471558	M101169	HRCN	12680005	X004478	STMC	12L300	P206280	DFLX
12034712	P207364	HRCN	12350A	P206343	HDMI	12471752	M060479	HRCN	12680006	X004480	STMC	12L300AZ	P206280	DFLX
	P207364	GRST	12350FSA	P224669	NLSN	12486	J008681	HDMI	12680007	X004482	STMC	12L350	P206281	DFLX
12047E49	M045193	LEBR	123674	M100016	NAT	12488	J008681	HDMI	12680008	X004484	STMC	12L350AZ	P206281	DFLX
1205914	M065030	AMHO	123684	M120235	AGCO	1248880	M120225	CAT	12680009	X004539	STMC	12L400	J190023	DFLX
12061422	P206403	ICAB		M120235	AGEM		M120225	TIM	127026R92	M085023	NAVI		P207338	HDMI
12061426	P206407	ICAB	123921	P208392	AGEM	12488A	J008681	HDMI	12723327	P226145	CRMY	12L400A	P207338	HDMI
12066600	J190020	HRCN	12400	P206282	DFLX	1249281H1	M045237	KTSU	12726548	X004478	CRMY	12L400AZ	P206282	DFLX
12067300	P207322	HRCN		P206345	HDMI		M045237	DRSS	12726581	X004482	CRMY	12L400CP	P206285	DFLX
12068615	P206366	HRCN	12400A	P206345	HDMI	1250	P207335	XAIR	12754	P270542	WIRG	12L500	P206283	DFLX
12069320	P207322	HRCN	12400CP	P206285	DFLX	12500	P206283	DFLX	1279133	M001506	CAT		P207340	HDMI
1207032	M085090	AMHO		P206353	HDMI		P206348	HDMI	1282347	M090594	PIE	12L500A	P207340	HDMI
	M085090	RYGO	12400F	J190002	HDMI	12500A	P206348	HDMI	12826	M060158	TMCO	12L500AZ	P206283	DFLX
1207032A	M085090	RYGO	12400FA	P206344	HDMI	12500CP	P206286	DFLX	12827	P207333	TMCO	12L500CP	P206286	DFLX
12109	M090362	YPEI	12400FS	P206344	HDMI		P206354	HDMI	128453	M002119	AGEM	12L600AZ	P207359	DFLX
12158602	M065034	ICMFB	12400FSA	P206344	HDMI	12500F	P206347	HDMI	12855	M065044	TMCO	12M21698A	J028528	HDMI
	M065034	ICAB	1240106	X004482	TREX	12500FA	P206347	HDMI	128974	P207325	IRT	12P1726A	J009560	HDMI
12158905	P270534	ICAB		X004538	KOEH	12500FCP	P207346	HDMI	129434C	M100146	OKSH	12P200	P207347	DFLX
1222204	P270539	TREX	1240118	X004480	KOEH	12510	J190003	HDMI	12967141	H001039	VLVO	12P250	P207349	DFLX
1222282	P270541	TREX	1240122	X004484	KOEH	12510A	J190003	HDMI		H001039	ECLD	12P275	P207350	DFLX
122382	P271507	ME		X004484	TREX	12510CP	J190004	HDMI	12969628	M090534	ECLD	12P300	P207351	DFLX
12250	P206279	DFLX	1240124	P206411	KOEH	12512	P207339	HDMI	12969629	P206364	ECLD	12P400	P207353	DFLX
122614	M120749	AGEM	1240142	X004478	KOEH	12512A	P207339	HDMI		P206364	VALM	12P400AZ	P207353	DFLX
1226244	P207335	SLVN	124066080	P206407	KOEH	12512CP	J009547	HDMI		P206364	SISU	12P500	P207354	DFLX
			12408	P206407	TREX	12514222	X004484	ECLD	12969630	X007784	ECLD			

Mfgs. No.	Our No.	Mfg. Code	Mfgs. No.	Our No.	Mfg. Code	Mfgs. No.	Our No.	Mfg. Code	Mfgs. No.	Our No.	Mfg. Code	Mfgs. No.	Our No.	Mfg. Code
12P500AZ	P207354	DFLX		M090158	DMAG	135036	P208348	HDMI	1408383	M070069	PIE	14500	P206298	HDMI
12P500CP	P216169	DFLX		M090158	MH	135036A	P208348	HDMI	1408389	P270538	PIE	14500A	P206298	HDMI
12PL200	P207347	DFLX	13093075	J009604	IR	135036CP	P208348	HDMI	1408390	P207363	PIE	14534	M100465	ADUM
12PL300	P207351	DFLX		J009604	SKYJ	135048	P207286	HDMI	1408396	J190044	PIE	14537	M100213	ADUM
12PL300AZ	P207351	DFLX		J009604	VLVO	135048A	P207286	HDMI	140852A	X004482	OKSH	145777001	M085207	VMER
12PL350AZ	P207352	DFLX		J009604	CUMS	13500D	P207328	XAIR	140930808	P226156	HOIST	14601	P206372	TRUX
1300	P206341	XAIR	13093083	J009605	IR	1350PE	J190014	XAIR	14099	X004478	EIMC		P206372	AP
13000011	P207324	PERK	13094974	P208326	KTSU	13535	M070008	HAWK	1410384	M001703	CAT	14602	P206373	TRUX
13000065	P206335	PERK		P208326	MH	135511	M100465	ECS	1411039	P213191	PBLT	14603	P206374	TRUX
13000066	P206334	PERK		P208326	DMAG		M100465	TESSI	1411480	M001668	CAT	14605	P206375	TRUX
13000077	P270531	PERK	130DD3A4	M065030	EIMC	135513	P206409	MACD		M001668	DCVG		P206375	AP
13000080	P206336	PERK	1310030180	M002119	ATCO	1358326	H001279	NACO	1413209	M110028	PBLT	14618	P206302	AP
13000111	M065030	PERK	1310030702	J009514	ATCO		H001279	HSTR	1413313	M120365	PBLT		P206302	TRUX
13000154	P207324	PERK	1310032059	X004537	ATCO	1361200	P270536	NACO	1413371	P206521	PBLT	14619	P206303	TRUX
13000177	M065074	PERK	1310032133	P206410	ATCO		P270536	HSTR	1413842001	M100580	PBLT		P206303	AP
13000214	P206339	PERK	1310032134	P270539	ATCO	136200	P270536	NACO	1413842002	M100582	PBLT	14620	P206304	TRUX
13000243	M065044	PERK	1310032512	M080024	ATCO	1362100	P270536	NACO	1413842003	M100944	KW		P206304	TRUX
13000271	M100572	PERK	1310033307	P270543	ATCO	136332	J008671	ELECT		M100944	PACC	14621	J014621	AP
13000275	J000216	PERK	1310033673	X007784	ATCO		J008671	DIA	141385001	P206398	VMER	14622	J014622	AP
13000277	P270539	PERK	131048	P206411	CAT	1366LL2001	M101181	SPRT	1413927	P206521	PBLT	14623	J014623	AP
13000284	P206279	PERK		P206411	BLNT	1375330	M100213	OKSH		P206521	IMP	14625CONN	P206374	DMT
	P207349	PERK	1310484800	J000204	ATCO		M100213	MNLS		P206521	KW	14634	P206927	AP
13000361	P207347	PERK	13112374	M090301	MH	1386049	X004476	NH	1413972	M110143	PACC	1463763	X004482	CAT
13000380	P206336	PERK		M090301	KTSU		X004476	FMCO		M110143	PACC	146654001	P207363	VMER
13000402	M045237	PERK		M090301	DMAG		X004476	CASE		M110143	KW	14694ELBOW1	P206340	DMT
13000403	P206403	PERK	131204	M090594	TMLS	13861232	P270543	IR	1416	P206345	XAIR	14694ELBOW2	P206339	DMT
13000404	P270532	PERK		M090594	CLAC	13902	P207405	XAIR	141674R91	M085008	NAVI	14694REDUCER	P206324	DMT
13000451	M065074	PERK	1312885H1	M001702	CETCO	13903	P206372	XAIR	1416PE1	P207329	XAIR	14737	J240007	TRUX
13000494	M045193	PERK		M001702	KTSU	13904	P206374	XAIR	14189	X004480	EIMC	14738	P224479	TRUX
13000502	P206338	PERK	1313106	P270532	NACO	13905	P206375	XAIR	14189	X004480	EIMC	14739	J240006	TRUX
13000509	P206337	PERK	13145271	M085207	IR	13906	P207408	XAIR	1421026	H002129	SCNA	14740	P224481	TRUX
13000511	J000203	PERK	131539	P206410	AUST	13925	P206371	XAIR	1421027	H001035	SCNA	14759ELBOW	P206344	DMT
13000514	M120108	PERK	13157078	M100049	IR	1392697	P207362	PIE	142531	P207332	KRES	147887001	P206556	VMER
13000518	J000217	PERK	1316600	P226156	HSTR	1392703	P206341	PIE	142572	M100049	KTSU	14817ELBOW	P206340	DMT
13000521	P206336	PERK	13166871	M101169	IR	13935	P206373	XAIR	142650	X004484	KSHA	1485AL	P206540	RKRM
13000522	P206346	PERK	13169552	P206323	IR	1394219	P207325	CAT	1427684	M101158	PIE	1487001	M122300	DLTC
13000523	P207362	PERK		P206323	VLVO	1396482	X004478	PIE	1430391H1	M065034	DRSS	1488910	M100465	OKSH
13000529	M085409	PERK	13195474	M060158	DMAG	13P400	P207353	DFLX		M065034	KTSU	149054	M080024	KSHA
13000530	M002119	PERK		M060158	MH	13P500	P207354	DFLX	1430469	X007785	CAT	1490AL	P206540	RKRM
13000532	P206324	PERK		M060158	BAR	13PL400	P207353	DFLX	1432461H1	M090594	KTSU	149111001	P207366	VMER
13000534	P207365	PERK		M060158	IR	13PL500	P207354	DFLX		M090594	DRSS	149126001	P207366	VMER
13000535	P270541	PERK	13198074	P270533	MH	13PS4174	M120225	RCHD	1432462H1	M085056	KTSU	1495014M1	M070008	MF
13000539	J000232	PERK		P270533	KTSU	1400	P206344	XAIR		M085056	DRSS	14B400	J092679	HDMI
13000543	M065140	PERK	1320103	J000227	JLGI	140018	P207282	HDMI	14335ELBOW1	P207322	DMT	14B400A	J092679	HDMI
13000544	M120566	PERK	1320128	X004478	JLGI	140018A	P207282	HDMI	14335ELBOW2	P207328	DMT	14B500	J092689	HDMI
13000560	M002120	PERK	1320129	X004482	JLGI	140018CP	P224627	HDMI	14339	P206372	TRUX	14B500A	J092689	HDMI
13000561	M002121	PERK	1320129	X004482	JLGI	140024	J024737	HDMI	14340	P206373	AP	14MK1696AZ	J028528	DFLX
13000562	M002118	PERK	132016	M090074	TESSI	140024A	J024737	HDMI	14341	P206374	TRUX	14Z4D104	P270536	PH
13000571	M101171	PERK	132038	M100582	TESSI	140036	P208364	HDMI	14343	P206308	AP		P270536	CTRY
13000573	M065142	PERK		M100464	TESSI	140036A	P208364	HDMI		P206308	TRUX	14Z4D118	P270541	CTRY
13000578	J000206	PERK	13271606	M091047	IR	1400458	P206282	OTWA	14344546	P270539	VLVO		P270541	PH
13000579	M002118	PERK		M091047	VLVO	140048	P207287	HDMI	14344547	P270536	VLVO	14Z4D16	P270543	PH
13000580	J000206	PERK	1331909	J240006	HSTR	140048A	P207287	HDMI	14354	M100465	ADUM	150003	M060037	TESSI
13000622	J190044	PERK	13339189	J009648	IR	140060	P207288	HDMI	1437118H91	H001035	KTSU	150004	M065030	TESSI
13000637	J190017	PERK	13339213	M070325	IR	140060A	P207288	HDMI	1437119H91	H001034	KTSU	150005	M070068	TESSI
13000650	M065071	PERK	13393566	P226152	IR	140060CP	P207299	HDMI	1437125H1	J009648	KTSU	150006	M070068	TESSI
13000652	P270534	PERK	1341259	M001702	CAT	140136CP	P224628	HDMI	1437128H1	J009649	KTSU		M070069	TESSI
130024	P216191	HDMI	134203	M090074	CLAC	140148CP	P224605	HDMI	1437164H1	P270539	KTSU	150007	M080024	TESSI
130024A	P216191	HDMI		M090074	TMLS	14017ELBOW	P206282	DMT	1437165H1	P270541	KTSU	150008	M090091	TESSI
130036	P208324	HDMI	134226	P222750	AGEM	14020	P207411	XAIR	143876	J000220	AGEM	15001	M120154	RKRM
130036A	P208324	HDMI	134227	M090072	AGEM	14025	P206366	XAIR	14400	P206297	HDMI	150018	P207283	HDMI
130048	P207285	HDMI	1342569	M080018	PIE	1402841	M120365	GRDL	14400A	P206297	HDMI	150018A	P207283	HDMI
130048A	P207285	HDMI	1342571	P270536	PIE	14030	P206367	XAIR	1444251	P206405	TIM	150018CP	P207283	HDMI
130048CP	P207314	HDMI	1344554	P207326	PIE	14035	P206368	XAIR		P206405	CAT	150024	J024739	HDMI
1300670	P206327	PIE	1344555	P206340	PIE	140359804	P207282	HOIST	144634	M090535	KSHA	150024A	J024739	HDMI
1300PE	P207326	XAIR	1344558	P206367	PIE	1403748	M090146	PLOC	1446492	P224600	SCNA	150024CP	J240024	HDMI
13013	M100572	TMCO	134591	M090544	TESSI	1403778	M060158	PLOC	1446494	P206611	SCNA	15003	M120100	RKRM
130245	J000232	AGEM	1350	P206342	XAIR	14040	P206369	XAIR	1446495	M100582	SCNA	150036	P208380	HDMI
1305433H1	P224617	KTSU	135018	P207281	HDMI	14050	P206370	XAIR	1446498	P206512	SCNA	150036A	P208380	HDMI
1305839	P270539	NACO	135018A	P207281	HDMI	14060	P207414	XAIR	1446499	J009429	SCNA	150036CP	J340023	HDMI
	P270539	HSTR	135024	J024735	HDMI	140760801	M090594	HOIST	1446501	P206641	SCNA	150048	P207292	HDMI
13082374	M090158	KTSU	135024A	J024735	HDMI	140761801	P206316	HOIST	1446502	X007785	SCNA	150048A	P207292	HDMI
						140762806	P206369	HOIST	1446504	P226147	SCNA			

CROSS REFERENCE

(See first page of this section for Manufacturer's Code Listing)

Mfgs. No.	Our No.	Mfg. Code	Mfgs. No.	Our No.	Mfg. Code	Mfgs. No.	Our No.	Mfg. Code	Mfgs. No.	Our No.	Mfg. Code	Mfgs. No.	Our No.	Mfg. Code
17536	P208374	XAIR	18377	J009648	RWMF	190046	J190046	AP	H001278	AGCO	1909532	M090520	STMC	
17548	P206383	XAIR	18400	P206410	HDMI	190054	J190054	AP	19035	P206370	CAT	1909537	M090547	STMC
1755012	M085090	GRDL	18400CP	J009486	HDMI	190055	J190055	AP		P206370	BLNT	1909538	M090280	STMC
17560	P208394	XAIR	18409	M065071	RWMF	190056	J190056	AP	1903842M91	H001284	DETZ	1909542	M090538	STMC
176066740	P206321	BADG	18410	M100464	RWMF	190057	J190057	AP		H001284	AGCO	1909545	M090280	STMC
176080988	J034673	BADG	18411	M065034	RWMF	190058	J190058	AP		H001284	MF	1909548	M090563	STMC
176321	P207367	CAT	18416	M101167	RWMF	190059	J190059	AP	19043388	J024836	DLTC	1909550	M090534	STMC
	P207367	BLNT	18420	M080018	RWMF	190060	J190060	AP	1906407	X007805	Marine	1909551	M090280	STMC
17692	X004484	ADUM	18421	M090594	RWMF	190061	J190061	AP		X007805	SHUT	1909553	M090680	STMC
17693	X007784	ADUM	18422	M085171	RWMF	190062	J190062	AP	190699	M085090	SLIC	1909700	M065065	STMC
1769937	P206516	PIE	18427	P206318	RWMF	190063	J190063	AP	190704	P226151	SLIC	1909702	M065065	STMC
17765	M070008	PETTI	18429	M001505	RWMF	1901107	M100465	STMC	1908250	M065065	STMC	1909703	M065065	STMC
1796899	M090538	CLRK	18434	P207366	RWMF	1901125	M120382	STMC	190849	P208330	SLIC	1909801	M085171	STMC
17B30012SS	J240003	HDMI	18440	P206411	RWMF	1901126	M110189	STMC	190851	X004536	SLIC	1909809	M090544	STMC
17B30018SS	P206552	HDMI	1848432	H001284	FIAT	1901134	M120418	STMC	190861	P207596	SLIC	1909855	M110049	STMC
17B30024SS	J240004	HDMI		H001284	CASE	1901140	M110077	STMC	190876	J000231	SLIC	1909858	M110014	STMC
17B35012SS	J240005	HDMI	1849425	X004480	CASE	1901150	M110012	STMC	190889	J190013	SLIC	1909860	M110052	STMC
17B35018SS	P206553	HDMI		X004480	FIAT	1901157	M090280	STMC	1909004	M065071	STMC	1909869	M100464	STMC
17B35024SS	J024850	HDMI	1849471	H001278	FIAT	1901160	M090158	STMC	1909006	M060232	STMC	1909870	M100464	STMC
17B40012	P224479	HDMI		H001278	CASE	1901180	M085023	STMC	1909007	M065065	STMC	1909872	M100580	STMC
17B40012SS	J024006	HDMI	1849473	H001034	FIAT	1901181	M090547	STMC	1909010	M060232	STMC	1909887	M100448	STMC
17B40018	J024754	HDMI		H001034	CASE	1901187	M100466	STMC	1909018	M065065	STMC	1909892	M100465	STMC
17B40018SS	P206554	HDMI	1849479	H001035	FIAT	190120012	J190044	PALA	1909057	M060055	STMC	1909898	M100463	STMC
17B40024	J024835	HDMI		H001035	CASE	190120015	P207394	PALA	1909063	M065065	STMC	1909926	M120382	STMC
17B40024SS	J024836	HDMI	18500	P206411	HDMI	1901204	M100213	STMC	1909065	M060232	STMC	1912400	X007829	CAT
17B40036	J034743	HDMI	18500CP	J009487	HDMI	1901205	M100695	STMC	1909121	M080018	STMC	191419	P207415	DIA
17B40036SS	J034673	HDMI	18571	M090072	URIG	1901208	M110189	STMC	1909122	M070028	STMC		P207415	ELECT
17B40048	P226142	HDMI	18600	P207667	HDMI	1901220	M120566	STMC	1909123	M090362	STMC	1920915	X004539	FAUN
17B50012	J240007	HDMI	186548	M070008	GRDL	1901221	M090547	STMC	1909131	M065065	STMC	192256	P206508	SLIC
17B50012SS	J240007	HDMI	1878529	M090595	PALA	1901231	M100807	STMC	1909135	M070008	STMC	192257	P206543	SLIC
17B50018	J024755	HDMI	188347	J240006	ELECT	1901234	M100695	STMC		M070008	FIAT	192258	P207290	SLIC
17B50018SS	P206555	HDMI		J240006	DIA	1901289	M100052	STMC	1909146	M070050	STMC	1925199	X004480	SISU
17B50024	J024837	HDMI		J240006	FEDR	1901292	M090547	STMC	1909207	M085008	STMC		X004480	ECLD
17B50024SS	J024838	HDMI	18838	P206345	BVER	1901299	M065065	STMC	1909208	M085023	STMC		X004480	VALM
17B50036	J034744	HDMI	188383	P206345	BVER	1901302	M065034	STMC	1909218	M085207	STMC	1928766	X004482	ECLD
17B50036SS	J034674	HDMI	18940	M120131	CC	1901303	M090170	STMC	1909230	M085207	STMC	19298108	J000233	IR
180005348	M090595	VMER	18A0557	M070050	LKBT	1901304	M085056	STMC	1909234	M085171	STMC	19298116	P206411	IR
180006147	P206602	VMER		M070050	FMC	1901305	M085207	STMC	1909241	M085189	STMC	19300	P206600	HDMI
180006149	P206603	VMER	18A23165S	M120108	FMC	1901311	M090563	STMC	1909245	M085172	STMC	19300Z	P206600	HDMI
180009	J000202	NOVA	18A2316S	M120108	FMC	1901314	M111026	STMC	1909248	M090563	STMC	1930115	H001278	FIAT
180011547	M002120	VMER	18A300	J000200	HDMI	1901331	M060247	STMC	1909250	M085172	STMC		H001278	CASE
180011827	P270538	VMER	18A350	J000201	HDMI	1901332	M085090	STMC	1909300	M090544	STMC		H001278	NH
180124	M060158	SLIC	18A3784	M120108	LKBT	1901334	M045193	STMC	1909303	M090544	STMC	19350	P206601	HDMI
180316	M065034	SLIC		M120108	FMC	1901335	M065044	STMC	1909306	M090544	STMC	19350CP	P206609	HDMI
180363	M045237	SLIC		M120108	LBX	1901336	M090595	STMC	1909310	M090072	STMC	19350Z	P206601	HDMI
180697	X004478	CASE	18A400	J000202	HDMI	1901337	M100572	STMC	1909316	M090594	STMC	19400	P206602	HDMI
18077	P206366	GOE	18A4A305	X004484	FMC	1901342	M120135	STMC	1909327	M090535	STMC	19400CP	P206610	HDMI
180864	P215307	CASE		X004484	LKBT	1901343	M085008	STMC	1909333	M090009	STMC	19400Z	P206602	HDMI
	P215307	AUST	18A500	J000203	HDMI	1901345	M090544	STMC	1909336	M100464	STMC	194027	M001503	DWCH
1810110	X004539	OKSH	18A557	M070050	FMC	1901346	M100582	STMC	1909341	M090146	STMC		M001503	CMWK
18110	J018110	AP	18H0419	M120100	FMC	1901348	M122300	STMC	1909344	M090544	STMC	194027A	M001432	CMWK
181338	P270531	DIA	190002	J190002	AP	1901351	M120235	STMC	1909348	M090544	STMC	194049	M001702	CMWK
	P270531	FEDR	190003	J190003	AP	1901352	M100465	STMC	1909349	M090544	STMC		M001702	DWCH
	P270531	ELECT	190004	J190004	AP	1901353	M100465	STMC	1909350	M100464	STMC	194064	J008671	CMWK
18144	P270542	AP	190009	J190009	AP	1901358	M090544	STMC	1909351	M090146	STMC	194137A	M060158	CMWK
	P206368	AP	190011	P207332	AP	1901360	M090074	STMC	1909352	M090544	STMC	194181	M001703	DWCH
18154F	M085008	OKSH	1900120015	P207394	PALA	1901361	M090781	STMC	1909353	M090544	STMC		M001703	CMWK
18154FX	M085008	OKSH	190013	J190013	AP	1901362	M120100	STMC	1909354	M090535	STMC	194181A	M001703	DWCH
181DGE00E0523	P206508	AGEM	190014	J190014	AP	1901373	M100049	WLKR	1909376	M090146	STMC		M001703	CMWK
18200	P206403	HDMI	190016	J190016	AP	1901378	M100695	WLKR	1909377	M090781	STMC	194202	M001504	DWCH
18225	P206404	HDMI	190017	J190017	AP	1901382	M100465	STMC	1909400	M120100	STMC	194284A	J008681	CMWK
18250	P206405	HDMI	190019	J190019	AP	1901383	M090595	STMC	1909401	M120108	STMC	194375	J024748	CMWK
18275	P206406	HDMI	190020	J190020	AP	1901384	M090544	STMC	1909416	M120154	STMC	194375A	P208330	CMWK
18300	P206407	HDMI	190023	J190023	AP	1902490	M070069	CLJL	1909427	M120176	STMC	194451	M001668	CMWK
18325	P206408	HDMI	190025	J190025	AP		M070069	SISU	1909428	M120131	STMC	194456	M101168	CMWK
1834224	M001566	CAT	190026	P206286	AP		M070069	ECLD	1909437	M120365	STMC	194456A	M101168	CMWK
	M001566	EAGP	190027	J190027	AP		M070069	CLRK	1909451	M120367	STMC	194479A	M060251	CMWK
183422400	M001566	CAT	190037688	P207408	PALA		M070069	VALM	1909500	M090158	STMC	194625	X004484	PRVT
18350	P206409	HDMI	1900401	M060232	STMC	1902493	M085008	CLRK	1909505	M090280	STMC	194843	X004482	PRVT
183670	J009612	CUMS	190041	J190041	AP	19030	M100052	RKRM	1909515	M120382	STMC	19500	P206603	HDMI
18375	P207353	RWMF	190042	J190042	AP	1903193M91	H001278	MF	1909526	M090301	STMC	19500043	P206602	PRVT
18376	J009636	RWMF	190044	J190044	AP		H001278	DETZ	1909528	M090538	STMC	19500183	J000203	PRVT
			190045	J190045	AP									

(See first page of this section for Manufacturer's Code Listing)

Mfgs. No.	Our No.	Mfg. Code	Mfgs. No.	Our No.	Mfg. Code	Mfgs. No.	Our No.	Mfg. Code	Mfgs. No.	Our No.	Mfg. Code	Mfgs. No.	Our No.	Mfg. Code
		P206600 ... WLKR	20C400	X007784	HDMI	2100991.....	P206510	STMC	21126.....	M060232 ...	WLKR	2132550.....	P226157	STMC
2071286.....		P206601 ... STMC	20C500	X007785	HDMI	2100992.....	P206511	STMC	21127.....	M060232 ...	WLKR	21328.....	M065065 ...	WLKR
		P206601 ... WLKR	20E01K1520	P270536	KTSU	2100993.....	P206512	STMC	21136.....	M065044 ...	KUTK	21331.....	M060232 ...	WLKR
2072019.....		M120108 ... TRJN	20S200	J190056	HDMI	2100995.....	P206511	STMC	21137.....	P206405 ...	KUTK	2133640.....	J034743 ...	WLKR
207201900.....		M120108 ... EATN	20S225	J190057	HDMI	2101000.....	P206512	STMC	21151.....	M065065 ...	WLKR		J034743 ...	STMC
2073181.....		M065034 ... EATN	20S250	J190058	HDMI	2101116.....	M120448 ...	CRAN	211516500.....	M090210 ...	TREX	2133650.....	J034744 ...	STMC
207335.....		P207335 ... ENGN	20S275	J190059	HDMI	210121.....	M070028 ...	CRAN	2115188.....	P206408 ...	TREX		J034744 ...	WLKR
207366.....		P207366 ... YOUNM	20S300	J190060	HDMI	21013.....	M090544 ...	CRAN		P206408 ...	OK	2134056.....	P207331 ...	CAT
207368.....		P207368 ... VMER	20S350	J190061	HDMI	21016.....	M070028 ...	CRAN	211618R91.....	M085023 ...	NAVI	2134083.....	M100582 ...	CAT
2076550.....		M085023 ... TRJN	20S400	J009623 ...	HDMI	21018.....	M085023 ...	WLKR	21169.....	M060232 ...	WLKR	2134840.....	P226142 ...	STMC
207655000.....		M085023 ... TRJN	20S500	J009624 ...	HDMI		M120100 ...	CRAN	21174.....	M120100 ...	WLKR	21365.....	M065065 ...	WLKR
		M085023 ... EATN	2100002.....	P206520 ...	STMC	21021.....	M065065 ...	WLKR	2117521.....	X004476 ...	BLDY	21372.....	M060232 ...	WLKR
20779.....		P206408 ... QUIN	2100003.....	P206521 ...	STMC	21022.....	M060232 ...	WLKR	2117539.....	X004480 ...	BLDY	21374.....	P222018 ...	HDMI
2078196.....		P206602 ... STMC	21000038.....	P207329 ...	ASTEC	21023.....	M085023 ...	CRAN	21188.....	M045237 ...	WLKR	21384.....	J009611 ...	HDMI
		P206602 ... WLKR		P207329 ...	AST	21024.....	M120365 ...	CRAN	212.....	J000221 ...	AP	2139921.....	M090158 ...	BLWL
2078201.....		P206603 ... WLKR	21000039.....	P206336 ...	ASTEC	21025.....	M045237 ...	WLKR	2120401292.....	M090535 ...	REX	214.....	J000222 ...	AP
		P206603 ... STMC		P206336 ...	AST	21026.....	M100049 ...	CRAN	2120402592.....	M090170 ...	RXRDR	2140057.....	P226142 ...	STMC
2078215.....		P207596 ... WLKR	2100004.....	P224481 ...	STMC	21028.....	M060232 ...	WLKR	2120403292.....	M060158 ...	MIIN	2140071.....	P226143 ...	STMC
		P207596 ... STMC	21000042.....	P206399 ...	ASTEC	21030.....	M100049 ...	CRAN		M060158 ...	RXRD	2140530.....	P226129 ...	STMC
2079903.....		M090534 ... GM		P206399 ...	AST		M065065 ...	WLKR	2120403492.....	M070069 ...	RXRDR	2140535.....	P226154 ...	STMC
2080012.....		P222748 ... STMC	21000043.....	P207353 ...	AST	2103006.....	M090301 ...	GRDL	2120979.....	J009429 ...	STMC	2140540.....	P226155 ...	STMC
2080102.....		J000224 ... STMC		P207353 ...	ASTEC	21035.....	M090544 ...	CRAN	2120980.....	J009429 ...	STMC	2140550.....	P226157 ...	STMC
2080103.....		J000227 ... STMC	21000044.....	P206395 ...	AST	21037.....	M090535 ...	CRAN	2120981.....	J009429 ...	STMC	2140562.....	J024835 ...	STMC
2080105.....		J000228 ... STMC		P206395 ...	ASTEC	21038.....	M085008 ...	CRAN	2120982.....	X005207 ...	STMC	2140563.....	J034743 ...	STMC
2080107.....		J000230 ... STMC	21000048.....	J008671 ...	ASTEC	21042.....	M100048 ...	CRAN	2120986.....	P206543 ...	STMC	2140564.....	P226142 ...	STMC
2080109.....		J000232 ... STMC		J008671 ...	AST	21046.....	M120100 ...	CRAN	2120995.....	P206540 ...	STMC	2140566.....	J024837 ...	STMC
2081801.....		M090170 ... FMC	21000085.....	M090074 ...	AST	21047.....	M120108 ...	CRAN	2121006.....	X005207 ...	WLKR	2140567.....	J034744 ...	STMC
20824.....		P206306 ... TRUX		M090074 ...	ASTEC	21048.....	M120131 ...	CRAN	21213.....	J009612 ...	HDMI	214059001.....	M065034 ...	VMER
208522.....		M080018 ... DRDT	21000090.....	J009636 ...	ASTEC	210486.....	P206309	Scompa	2121405.....	J024758 ...	STMC	2140590011.....	M065034 ...	VMER
2088102.....		J000224 ... WLKR		J009636 ...	AST	21054.....	M120154 ...	CRAN	21215.....	P206607 ...	HDMI	2140804.....	J024754 ...	STMC
		J000224 ... STMC	2100017.....	P206523 ...	STMC	21055.....	M080024 ...	CRAN	212361.....	M085008 ...	CUMS	2140806.....	J024755 ...	STMC
2088103.....		J000227 ... WLKR	2100019.....	P206526 ...	STMC	2105576.....	M120131 ...	TRJN	212362.....	M085023 ...	CUMS	2142445.....	P270543 ...	TREX
		J000227 ... STMC	21000195.....	P206393 ...	AST	210557600.....	M120131 ...	TRJN	2124312.....	J009613 ...	HDMI	2143292.....	M120225 ...	TREX
2088105.....		J000228 ... STMC		P206393 ...	ASTEC		M120131 ...	TRJN	212507592.....	M090538 ...	CLRK		M120225 ...	OK
		J000228 ... WLKR	21000198.....	P207362 ...	AST	21057.....	M100464 ...	CRAN	21259.....	M065065 ...	WLKR	21439.....	M065065 ...	WLKR
2088107.....		J000230 ... WLKR		P207362 ...	ASTEC	21058.....	P206319 ...	GTMN	21287.....	M060232 ...	WLKR	21464.....	M090362 ...	WLKR
		J000230 ... STMC	2100022.....	P206524 ...	STMC	21059.....	M065065 ...	WLKR	212A1014.....	P206333 ...	AP	21465.....	M100049 ...	WLKR
2088109.....		P206410 ... CRMY	2100023.....	P206525 ...	STMC	2106001.....	M090301 ...	VMER	212A1016.....	P206333 ...	TRUX	21470.....	M070028 ...	WLKR
		J000232 ... STMC	21000360.....	P207363 ...	ASTEC	21060011.....	M090301 ...	VMER		P206333 ...	AP	21475.....	M065065 ...	WLKR
		J000232 ... WLKR		P207363 ...	AST	21066.....	M090538 ...	CRAN		P206333 ...	AP	21476.....	M085023 ...	WLKR
208852.....		M070028 ... DRDT	2100048.....	M120131 ...	CRAN	21067.....	M100464 ...	CRAN	212K1014.....	P206333 ...	AP	21476.....	M085023 ...	WLKR
2089167.....		M085008 ... TRJN	21000793.....	P207326 ...	AST	21068.....	M065065 ...	WLKR	212K7514.....	P206333 ...	AP	21495.....	M060232 ...	WLKR
208916700.....		M085008 ... TRJN		P207326 ...	ASTEC	21068.....	M065065 ...	WLKR	2130010.....	P226148 ...	STMC	2150066.....	P226146 ...	STMC
		M085008 ... EATN	2100083.....	M120197 ...	CRAN		P207394 ...	PDCI	2130015.....	P226149 ...	STMC	2150400.....	P226147 ...	STMC
2089643.....		M070068 ... EATN	21001004.....	P207324 ...	AST	2106828.....	M002121 ...	CAT	2130020.....	P226148 ...	STMC	2150651.....	P226145 ...	STMC
		M070068 ... TRJN		P207324 ...	ASTEC	2106829.....	M002121 ...	CAT		P226148 ...	WLKR	2150671.....	P226144 ...	STMC
		M070068 ... YALE	2100116.....	M120448 ...	CRAN	21070.....	M090535 ...	CRAN	2130026.....	P226141 ...	STMC	2150735.....	P226133 ...	STMC
208964300.....		M070068 ... TRJN	2100128.....	M120131 ...	CRAN	21072.....	M120197 ...	CRAN	2130530.....	P226129 ...	STMC	2150740.....	P226156 ...	STMC
2090008.....		P207784 ... STMC	21001321.....	M120225 ...	ASTEC	21074.....	M090547 ...	WLKR	2130535.....	P226154 ...	STMC	2150750.....	P226158 ...	STMC
2090696.....		P206507 ... STMC		M120225 ...	AST		M120365 ...	CRAN	2130540.....	P226155 ...	STMC	2150808.....	P206552 ...	STMC
2090987.....		J008167 ... STMC	21001330.....	J009648 ...	ASTEC	21078.....	P206303 ...	LEVN	2130550.....	P226157 ...	STMC	2150809.....	P206553 ...	STMC
209115.....		J000230 ... Scompa		J009648 ...	AST		M100465 ...	CRAN	2131025.....	P226149 ...	STMC	2150810.....	P206554 ...	STMC
2091176.....		M120365 ... GM	21001385.....	J190042 ...	ASTEC	21079.....	P206304 ...	LEVN		P226149 ...	WLKR	2150812.....	P206555 ...	STMC
2092903.....		M070069 ... EATN		J190042 ...	AST	21082.....	M120189 ...	CRAN	2131030.....	P226140 ...	WLKR	2150867.....	P226152 ...	STMC
		M070069 ... TRJN	2100146.....	P206515 ...	STMC	21083.....	M120197 ...	CRAN		P226140 ...	STMC	2151020.....	P226151 ...	WLKR
		M070069 ... YALE	2100150.....	M085207 ...	CRAN	21090.....	M100463 ...	CRAN	2131035.....	P226141 ...	STMC		P226151 ...	STMC
209290300.....		M070069 ... TJAK	2100153.....	P206516 ...	STMC	21091.....	M100213 ...	CRAN		P226141 ...	WLKR	2151025.....	P226152 ...	STMC
		M070069 ... JNDR	2100164.....	M090091 ...	CRAN	21092.....	M100048 ...	CRAN	2131040.....	P226142 ...	STMC		P226152 ...	WLKR
2093622.....		M085023 ... EATN	2100165.....	M120225 ...	CRAN	21093.....	M100463 ...	CRAN	2131050.....	P226143 ...	STMC	2151030.....	P226144 ...	STMC
2094047.....		M065065 ... TRJN	2100167.....	P206517 ...	STMC	21094.....	M120235 ...	CRAN	2131060.....	P226150 ...	WLKR		P226144 ...	WLKR
209500200.....		M090158 ... TJAK	2100169.....	M100016 ...	CRAN	21095.....	M090091 ...	CRAN		P226150 ...	STMC	2151035.....	P226145 ...	STMC
		M090158 ... EATN	2100171.....	M140048 ...	CRAN	21097.....	M065065 ...	WLKR	21314.....	J009614 ...	HDMI	2151040.....	P226145 ...	WLKR
209802.....		X004476 ... VKSA	2100180.....	P206518 ...	STMC	21099.....	M120235 ...	CRAN	2131840.....	J024754 ...	WLKR	2151040.....	P226146 ...	STMC
209802B.....		X004536 ... VKSA	21003.....	M060232 ...	WLKR	21101.....	M085008 ...	WLKR		J024754 ...	STMC	2151050.....	P226147 ...	STMC
209802C.....		X004482 ... VKSA	2100338.....	P206519 ...	STMC	2110221.....	P206616 ...	STMC	2131850.....	J024755 ...	STMC	2151060.....	P226153 ...	WLKR
209802D.....		X004478 ... VKSA	2100360.....	P207363 ...	AST	21113.....	P206604 ...	HDMI	2132440.....	J024835 ...	STMC		P226153 ...	STMC
209802E.....		X004484 ... VKSA		P207363 ...	ASTEC	2111312.....	P206605 ...	HDMI		J024835 ...	WLKR	2151240.....	J240006 ...	STMC
20A300.....		J009604 ... HDMI	21004.....	M065065 ...	WLKR	211197.....	M090544 ...	CUMS	2132450.....	J024837 ...	STMC		J240006 ...	WLKR
20A350.....		J009605 ... HDMI	21007.....	M060232 ...	WLKR	211206.....	M100049 ...	CUMS	21325.....	M060232 ...	WLKR	2151250.....	J240007 ...	STMC
20A400.....		J009606 ... HDMI	2100793.....	P207326 ...	ASTEC	211213.....	M090072 ...	CUMS	2132530.....	P226129 ...	STMC	2151830.....	P206552 ...	WLKR
20A500.....		J009607 ... HDMI		P207326 ...	AST	21124.....	M060232 ...	WLKR	2132535					

Cross Reference

(See first page of this section for Manufacturer's Code Listing)



CROSS REFERENCE

Mfgs. No.	Our No.	Mfg. Code	Mfgs. No.	Our No.	Mfg. Code	Mfgs. No.	Our No.	Mfg. Code	Mfgs. No.	Our No.	Mfg. Code	Mfgs. No.	Our No.	Mfg. Code
2151840	P206554	WLKR	2170971	P207329	STMC	21837	M100049	WLKR	21971	M120382	WLKR	22300AZ	P206334	DFLX
	P206554	STMC	2170972	P206349	STMC	218371	P205834	KSHA	219802	M065034	DRDT	22300S	P224685	DFLX
2151850	P206555	STMC	2170973	P207327	STMC	21838	M085171	WLKR	21998	M065034	WLKR	2230745	M085056	FMC
	P206555	WLKR	2170974	P206346	STMC	218439	H001284	KSHA	21H0145	J240012	LKBT	22320220	M065044	IR
2152440	J024836	WLKR	2170975	P207331	STMC	2185	P206343	NAPA	2200	M002164	MOB	22320246	M100048	IR
	J024836	STMC	2170992	P207331	STMC	21850	M060232	WLKR	22000214	M100463	AST	22320253	M085090	IR
2152450	J024838	STMC	2171004	J190019	STMC	2188030	J008681	STMC		M100463	ASTE	22323	M060251	TMCO
	J024838	WLKR	2171006	P207364	STMC	2190093	P206331	STMC	2200086	P207367	STMC	2233448	X004478	FMC
2152530	P226132	WLKR	2171009	P207362	STMC	2190106	P206333	STMC	2200087	P206849	STMC	22337	M120366	WLKR
	P226132	STMC	2171010	P207366	STMC	2190110	J000127	STMC	2200092	P207368	STMC	22340350	M090301	IR
2152535	P226133	STMC	2171011	P207362	STMC	2190113	P206334	STMC	2200098	P206850	STMC	22344816	P206520	IR
2152540	P226156	STMC	2171013	P206346	STMC	2190118	P206335	STMC	22004	M090280	WLKR	22350	P206335	DFLX
215254001	M085208	VMER	2171014	P207362	STMC	2190125	P206336	STMC	22005	M100016	WLKR	22350AZ	P206335	DFLX
2152540011	M085208	VMER	2171015	P207332	STMC	2190143	P206338	STMC	2200815613	M100464	BLDY	2235724	M085023	FMC
2152550	P226158	STMC	2171016	P207332	STMC	2190345	P206337	STMC	2201032	P206851	STMC	223599	P206323	GRVE
2153640	J034673	STMC	2171188	P207363	STMC	2191J000218	J000218	MACK	2201080	P207369	STMC	22362	M060250	TMCO
	J034673	WLKR	217149	M090544	HSTR	2191J008681	J008681	MACK	22016	P206344	LEAR	2236206001	M100016	HRCN
2153650	J034674	STMC	21722	M045237	WLKR	2191J009605	J009605	MACK		P206344	FLTR	2236206186	J190002	HRCN
	J034674	WLKR	21723	M065071	WLKR	2191J0038612	J038612	MACK	22029	P206555	MOGU	2236206238	J009648	HRCN
21540	M065065	WLKR	217326	M090544	RYGO	2191J190003	J190003	MACK	22046	P207339	LEVN	2236209022	P207333	HRCN
21578	M060037	WLKR	21745	M065065	WLKR	2191KYX004476	X004476	MACK	22056	P206286	WLKR	2236408	M100048	FMC
21579	M065030	WLKR	2177	P206546	NAPA	2191KYX004478	X004478	MACK	220817	M085023	DRDT	2236410	X004482	FMC
21580	M070068	WLKR	2178014	P207364	STMC	2191KYX004480	X004480	MACK	220847	P270532	SLIC	22367007	M085056	IR
21581	M070069	WLKR	2180003	P207335	STMC	2191KYX004482	X004482	MACK	220861	M001505	DLTC	22373179	M101170	IR
21582	M080024	WLKR	2180004	P207333	STMC	2191KYX004484	X004484	MACK	2210112	P207415	STMC	22376255	M090158	IR
21584	M090091	WLKR	2180040	P207333	STMC	2191KYX004536	X004536	MACK	2210126	P206927	STMC	22381	M120131	WLKR
2160001	P206279	STMC	2180049	P207335	STMC	2191KYX004537	X004537	MACK	2210131	P206302	STMC	22382550	M060482	IR
2160004	P207350	STMC	2180054	P216172	STMC	2191KYX004539	X004539	MACK	2210141	P206303	STMC	22391	M090548	WLKR
2160048	P206279	STMC	2180058	P206341	STMC	2191M080018	M080018	MACK	2210148	P206304	STMC	22395867	M120750	IR
2160053	P207350	STMC	2180062	P206343	STMC	2191M080024	M080024	MACK	2210154	P207298	WLKR	22400	P206336	DFLX
2160056	P206280	STMC	2180064	P206345	STMC	2191M085171	M085171	MACK		P207298	STMC	22400AZ	P206336	DFLX
2160065	P206281	STMC	2180067	P206348	STMC	2191M090072	M090072	MACK	2210695	P206301	STMC	22400S	P224686	DFLX
2160070	P206282	STMC	2180075	P206340	STMC	2191M090091	M090091	MACK	2210696	P206303	STMC	2240164	P208338	STMC
2160074	J190025	STMC	2180079	P206342	STMC	2191M090535	M090535	MACK	2210697	P206304	STMC	2240176	P208358	STMC
2160506	P207359	STMC	2180081	P206344	STMC	2191M090544	M090544	MACK	2210698	P207298	STMC	2240463	P208374	STMC
2161012	P206286	STMC	2180084	P206347	STMC	2191M090594	M090594	MACK	221303	M045123	KSHA	2240470	P206383	STMC
2161126	P206280	STMC	2180096	P207338	STMC	2191M090595	M090595	MACK	221322	M090158	DRDT	2240630	P270539	FMC
2161127	P206281	STMC	2180381	P207339	STMC	2191M100052	M100052	MACK	22139455	M122300	IR	2240878	P208388	STMC
2161128	P206282	STMC	2180488	J008681	STMC	2191M100465	M100465	MACK	22139544	M122300	IR	2240880	P208394	STMC
2161129	J190025	STMC		P206344	CRMY	2191M100580	M100580	MACK	22139555	M122300	IR	2240882	J024748	STMC
2161144	P207346	STMC	2180508	P207341	STMC	2191M100582	M100582	MACK	221499	M100049	DRDT	2240883	J024750	STMC
2161146	J190023	STMC	2181002	P207345	STMC	2191M101158	M101158	MACK	22163	P216200	WLKR	224097	P207285	IR
2161147	J190027	STMC	2181003	P206353	STMC	2191M120382	M120382	MACK	22163	P216204	WLKR	2244018	P208386	WLKR
2161153	J190023	STMC	2181006	P207346	STMC	2191MFM090544	M090544	MACK	22168	P208359	WLKR	22445	M060480	WLKR
2161154	J190025	STMC	2181007	P206354	STMC	2191MPM090535	M090535	MACK	22169	P208375	WLKR	22449	M090534	WLKR
2161155	P207359	STMC	2181124	P207340	STMC	2191MPM100463	M100463	MACK	221694	M060232	DRDT	22452	M120418	WLKR
2161158	P206283	STMC	2181125	P206341	STMC	2191P206282	P206282	MACK	221694	M060232	DRDT	22453039	P206327	IR
21627	P206341	KUTK	2181126	P206343	STMC	2191P206283	P206283	MACK	2218000	P207559	STMC	22453047	P206328	IR
2169001	M085056	VMER	2181127	P206345	STMC	2191P206318	P206318	MACK	2220111	P206306	STMC	22453625	M110429	IR
21690011	M085056	VMER	2181128	P206348	STMC	2191P206333	P206333	MACK	2220119	P206308	STMC	22456172	M120235	IR
216931	M060055	DRDT	2181129	P206340	STMC	2191P206336	P206336	MACK	2220122	P206927	STMC	22456198	J190003	IRCR
2170003	P207322	STMC	2181130	P206342	STMC	2191P206344	P206344	MACK	2220124	P206309	STMC		J190003	TKNG
2170005	P207324	STMC	2181131	P206344	STMC	2191P206347	P206347	MACK	2220130	P206310	STMC		J190003	IR
2170006	P207325	STMC	2181132	P206347	STMC	2191P206375	P206375	MACK	2220133	P206311	STMC	22456701	P206521	IR
2170067	P206348	STMC	2181153	P207341	WLKR	2191P206400	P206400	MACK	2220136	P208392	STMC	224620	M090210	DRDT
2170147	P207322	STMC	2181154	P207339	STMC	2191P206410	P206410	MACK	2220967	P208386	STMC	2246593	M110189	CAT
2170151	P216174	STMC	2181182	P206344	STMC	2191P206615	P206615	MACK	2220979	P206310	STMC	2247830	H001279	FMC
2170156	P207324	STMC	2181183	P206340	STMC	2191P207339	P207339	MACK	2220981	P206311	STMC	22500	P206337	DFLX
2170160	P207325	STMC	2181185	P206344	STMC	2191P207408	P207408	MACK	2220982	P208338	STMC	2250006	P206612	WLKR
2170166	J190013	STMC	2181186	P206344	STMC	2191P207414	P207414	MACK	2220984	P206309	STMC	2250002	M090535	RIMP
2170171	P207328	STMC	2181187	P206341	STMC	2191P207596	P207596	MACK	2220985	P208358	STMC	22500AZ	P206337	DFLX
2170174	P207329	STMC	2181191	P206347	STMC	2191P208394	P208394	MACK	2220989	P208392	STMC	22500S	P224687	DFLX
2170179	P206349	STMC	2181194	P207339	STMC	2191P216197	P216197	MACK	22214	M090547	WLKR	225010	P206542	RIMP
2170182	P207326	STMC	2181195	P206350	STMC	2191P2070541	P2070541	MACK	22231	M090563	WLKR	225012	M090074	RIMP
2170188	P207327	STMC	2181196	J190004	STMC	2191WZM100464	M100464	MACK	222434	M100463	IVECO	2250190	P207568	STMC
2170194	P206346	STMC	2181201	P206340	STMC	2191X004482	X004482	MACK	22250	P206333	DFLX	2250205	P207567	STMC
2170203	P207331	STMC	2181202	P206342	STMC	21923	M120154	WLKR	22254965	P207341	IRCR	2250207	P207566	STMC
2170380	P207330	STMC	2181203	P206344	STMC	219567	P206406	NH		P207341	IR	225021	M100465	RIMP
2170494	P206346	STMC	2181204	P206344	STMC		P206406	CASE	222578	M120154	DRDT	225029	M170101	RIMP
2170507	P216175	STMC	2182	M090520	WLKR	21966	P216227	WLKR	22279590	P206344	IR	225039	M122300	RIMP
2170663	P207332	STMC	21833	M100048	WLKR	21968	M100052	WLKR	2228000	P207419	STMC	225043	M100463	RIMP
2170966	P216175	STMC	21835	M090072	WLKR	21969	M100146	WLKR	22300	P206334	DFLX	225048	M100463	RIMP

(See first page of this section for Manufacturer's Code Listing)

Mfgs. No.	Our No.	Mfg. Code	Mfgs. No.	Our No.	Mfg. Code	Mfgs. No.	Our No.	Mfg. Code	Mfgs. No.	Our No.	Mfg. Code	Mfgs. No.	Our No.	Mfg. Code
2250943.....	P207566	STMC	22789.....	M110012	WLKR	2298024.....	J009636	STMC	2320002.....	P206300	STMC	2387440011...	M100048	VMER
2250944.....	P207620	STMC	22808.....	M085008	WLKR	2298026.....	J009644	STMC	23207269.....	M170101	IR	2388025.....	P206410	TYLR
2251095.....	P207619	STMC	2280806.....	J000127	STMC	2298036.....	J009637	STMC	2320939.....	P205979	STMC	238884.....	P207324	KSHA
2251096.....	P207581	STMC	22809.....	M090544	WLKR	2298037.....	P207354	STMC	2320940.....	P205976	STMC	2390713.....	J000227	WLKR
2251097.....	P207620	STMC	22823.....	M090535	WLKR	2298038.....	J009645	STMC	2320941.....	P206299	STMC	J000227.....	STMC	
2251098.....	P207582	STMC	22828.....	M090544	WLKR	22984056.....	M090538	KOEH	2321070.....	M065065	CLRK	2390714.....	J000228	WLKR
2251254.....	P207567	WLKR	22829.....	M090535	WLKR	22991.....	M111029	WLKR	J000228.....	M065065	TREX	P206601.....	STMC	
	P207567	STMC	22833.....	M120365	WLKR	22H0492.....	M080024	LKBT	2323080.....	M085407	MRBR	2390715.....	J000230	STMC
2251259.....	J009393	STMC	22834.....	M090544	WLKR		M080024	FMC	23275.....	P206409	TMPO	2390716.....	J000232	STMC
2251261.....	P207581	STMC	22835.....	M100464	WLKR	22H0644.....	P207332	LKBT	23374.....	M090210	TMPO	2390728.....	J000233	STMC
2251262.....	P207567	STMC	228355.....	M090544	HSTR	2300010069.....	M120108	UPTI	2339654.....	M065034	FMC	J000233.....	WLKR	
2251264.....	P207581	STMC	22836.....	M100582	WLKR	230010002.....	M090544	VLVO	23400.....	P206299	HDMI	2390850.....	P206525	TYLE
2251265.....	P207568	STMC	22837.....	P206388	WLKR		M090544	WGMC	23419686.....	M065065	DD	2391621.....	P207282	TYLE
2251275.....	P207581	STMC	22838.....	P206389	WLKR	230010003.....	M100464	WGMC	23423601.....	M080024	PETB	2392079.....	P206382	TYLE
	P207581	WLKR	22843.....	M120197	WLKR	230010004.....	M090535	VLVO	23426.....	P206546	HAVA	2393084.....	M065065	CAT
2251277.....	P207568	WLKR	22844.....	M090146	WLKR	230010005.....	M090544	WGMC	2345.....	P206280	XAIR	2393341.....	P206508	TYLE
2251279.....	P207581	WLKR	22845.....	P206386	WLKR		M090544	WGMC	2345PE.....	P207351	XAIR	2398713.....	J000227	WLKR
22551.....	M090158	WLKR	22846.....	P206387	WLKR	230010008.....	M100463	WGMC	234A1014.....	J000127	AP	J000227.....	STMC	
22552.....	M120225	WLKR	22847.....	P206390	WLKR	230010009.....	M100464	VLVO	234A1016.....	J000127	AP	2398714.....	J000228	STMC
22566.....	M085267	WLKR	22848.....	P206391	WLKR	230010010.....	M100464	WGMC	J000127.....	TRUX		J000228.....	WLKR	
22572.....	M090594	WLKR	22851.....	M100463	WLKR		M100464	VLVO	234A1414.....	J000127	AP	2398715.....	J000230	WLKR
22583.....	M065065	WLKR	22856.....	P216228	WLKR		M100464	UPTI	234C1016.....	J000127	AP	J000230.....	STMC	
22600.....	P206338	DFLX	22863.....	P208389	WLKR	230010011.....	M100463	VLVO	J000127.....	DFLX		2398716.....	J000232	WLKR
22600AZ.....	P206338	DFLX	22864.....	P208395	WLKR	230010021.....	M120365	WGMC	23500.....	P206299	HDMI	J000232.....	STMC	
22604.....	M090547	WLKR	22866.....	M085172	WLKR		M120365	WSTI	235024.....	P208336	HDMI	23991.....	M060005	KOEH
2260801.....	M045237	FMC	2288000.....	P207419	STMC		M120365	VLVO	235024A.....	P208336	HDMI	2399991.....	M070068	VME
2261697.....	M065065	FMC	22882.....	P207320	WLKR	230010027.....	M120100	WGMC	235040011.....	X004482	VLVO		P206544	AP
22628.....	M065034	WLKR	22885.....	P207321	WLKR		M120100	VLVO	235043430.....	X009076	WSTI	240001.....	P206544	AP
22630.....	M070008	WLKR	22888.....	M110189	WLKR	230010047.....	M100463	WGMC	X009076.....	FRTL		240003.....	J240003	AP
22632.....	M090158	WLKR	22891.....	P216202	WLKR		M100463	VLVO	235043814.....	X007785	WSTI	240004.....	J240004	AP
22633.....	M090170	WLKR	22892.....	P207299	WLKR	230010051.....	M120197	WGMC	X007785.....	VLVO		240005.....	J240005	AP
22634.....	M100146	WLKR	22894.....	P207300	WLKR	230010052.....	M100464	WGMC	235043815.....	X007784	VLVO	240006.....	J240006	AP
22636.....	M085056	WLKR	22896.....	M090781	WLKR	230010054.....	M120365	VLVO	235048.....	P206377	HDMI	240007.....	J240007	AP
22637.....	M085207	WLKR	22897.....	M110189	WLKR		M120365	WGMC	235048A.....	P206377	HDMI	240012.....	J240012	AP
22663.....	M090563	WLKR	22899.....	M110189	WLKR	230010056.....	M100465	VLVO	235048A.....	P206377	HDMI	240016.....	J240016	AP
22665.....	M120367	WLKR	22899.....	M110189	WLKR	230010064.....	M100465	VLVO	23507610.....	P210110	ALSN	240018.....	P207297	HDMI
22691640.....	M100463	KTSU	22902.....	P207302	WLKR	230010066.....	M100043	VLVO	P210110.....	DD		240018CP.....	P208385	HDMI
	M100463	DMAG	2290220.....	P206397	STMC	230010069.....	M120108	VLVO	23507611.....	X006202	ALSN	24001965.....	P207541	CMI
	M100463	MH	2290221.....	P207364	STMC		M120108	UPTI	X006202.....	DD		240024.....	J240012	HDMI
2269681.....	M060232	FMC	2290224.....	P206398	STMC	230010070.....	M100465	VLVO	23507616.....	P206403	ALSN	J240024.....	AP	
2270257.....	P207281	STMC	2290227.....	P206399	STMC	230010072.....	M120100	WGMC	P206403.....	DD		P206389.....	TESSI	
2270260.....	P207282	STMC	2290229.....	P206400	STMC	230010073.....	M090544	VLVO	23507629.....	P213191	DD	240024A.....	J240012	HDMI
2270271.....	P207283	STMC	2290230.....	J009635	STMC	230010077.....	M120365	VLVO	P213191.....	ALSN		240048.....	P207295	HDMI
2270542.....	J024737	STMC	2290231.....	J009639	STMC	230010078.....	M100582	VLVO	2351588.....	M065030	CLRK	240048A.....	P206378	HDMI
2270544.....	P216191	STMC	2290232.....	J009641	STMC	230010081.....	M100580	VLVO	M065030.....	CLJL		240048CP.....	P206388	HDMI
2270547.....	J024735	STMC	2290260.....	P207361	STMC	230010088.....	M100582	VLVO	M065030.....	VME		240060.....	P207290	HDMI
2270551.....	J024739	STMC	22907.....	M122300	WLKR	230010084.....	M100582	MACK	23519686.....	M065065	ALSN	240060CP.....	P206390	HDMI
2270565.....	P208324	STMC	22909055.....	P206350	IRCR	230013215.....	M100582	VLVO	M065065.....	DD		240065.....	P208358	TESSI
2270566.....	P208324	STMC		P206350	IR	230013221.....	M120100	VLVO	235200015.....	X007784	UPTI	240072.....	J640001	HDMI
2270573.....	P208348	STMC	2291361.....	M085008	MRTZ	230013409.....	M100463	VLVO	23545.....	P206281	XAIR	240072A.....	J640001	HDMI
2270574.....	P208380	STMC	22915.....	M100213	WLKR	230013409.....	M100463	VLVO	23570001.....	M085056	RYGO	240072A.....	J640001	HDMI
2270577.....	P207285	STMC	22916.....	M100466	WLKR	230013410.....	M100465	VLVO	23570002.....	M070008	RYGO	2400749.....	P207282	STMC
2270578.....	P207287	STMC	22917.....	M120235	WLKR	230013411.....	M100465	VLVO	23570014.....	M090280	RYGO	240083.....	P208350	TESSI
2270579.....	P216197	STMC	22919.....	M100465	WLKR	230013417.....	M100463	VLVO	23570016.....	M060055	RYGO	2400860.....	J009648	STMC
2270585.....	P207286	STMC	22920.....	M100465	WLKR	230013420.....	M100465	VLVO	23570018.....	M090170	RYGO	2400865.....	J009650	STMC
2270586.....	P207292	STMC	22924.....	M100465	WLKR		M100465	WSTI	23570031.....	M090301	RYGO	240103.....	J014621	TESSI
2270590.....	P207288	STMC	22925.....	M100465	WLKR	230013428.....	M085171	WSTI	23570049.....	M065044	CMI	240114.....	P206309	TESSI
2270598.....	P207289	STMC	22936.....	M090544	WLKR	230013441.....	M100582	WSTI	2362507.....	M002120	CAT	240118A.....	P224696	HDMI
2270951.....	P206376	STMC	22937.....	M100695	WLKR	230013455.....	M100463	WSTI	23641.....	P270538	CRMV	240136CP.....	P224698	HDMI
2270952.....	P206376	STMC	22938.....	M100807	WLKR	230013463.....	M100944	WSTI	23642.....	P270539	CRMV	240224.....	M100146	SLAR
2270955.....	P206377	STMC	22940.....	M090074	WLKR	230013474.....	M101182	FRTL	2370035.....	M170101	RYGO	2403029.....	M065034	TYLR
2270958.....	P206378	STMC	22941.....	M090781	WLKR		M101182	WSTI	237010001.....	M090091	VLVO	2403031.....	M085023	TYLR
2270961.....	P206379	STMC	22943.....	M120100	WLKR	230013807.....	M100465	VLVO	237010002.....	M080024	VLVO	2403032.....	M070008	TYLR
2270962.....	P208393	STMC	22963.....	M100465	WLKR	230013815.....	M100464	VLVO	237013407.....	M090091	WSTI	2403033.....	M085008	TYLR
22766.....	M060247	WLKR	22965.....	M090544	WLKR	230024.....	P208328	HDMI	237013601.....	M090091	VLVO	2403034.....	M090544	TYLR
22767.....	M085090	WLKR	2296531.....	P206344	TYLE	230024A.....	P208328	HDMI	237779A1.....	P206369	CASE	2403036.....	M090009	TYLR
22769.....	M045193	WLKR	2296533.....	P206345	TYLE	230036.....	P206376	HDMI	2380904.....	P207314	STMC	2403037.....	M120100	TYLR
22770.....	M065044	WLKR	2296557.....	J008681	TYLE	230036A.....	P206376	HDMI	2380906.....	P224628	STMC	2403039.....	M090538	TYLR
22771.....	M090595	WLKR	22966.....	M100695	WLKR	230048.....	P206376	HDMI	2380908.....	P207299	STMC	2403044.....	M090210	TYLR
22774.....	M100016	WLKR	2296712.....	P206543	TYLE	230048A.....	P206376	HDMI	2380909.....	J340023	STMC	2403046.....	M090159	TYLR
22775.....	M100572	WLKR	2297136.....	M080018	FMC	2306635.....	M085172	GM	2380910.....	P207317	STMC	2403049.....	M090535	TYLR
22786.....	M120135	WLKR	2297365.....	M120225	MRTZ	230848.....	M060232	DRDT	2380911.....	P207300	STMC	2403052.....	M090146	TYLR
			2297959.....	P206407	FMC	2310254.....	P206547	STMC	2380912.....	J240024	STMC	2403054.....	M100464	TYLR
			2298016.....	J009631	STMC	23162.....	M100049	HAVA	238744001.....	M100048	VMER	2403057.....	M070069	TYLR

Cross Reference

(See first page of this section for Manufacturer's Code Listing)



CROSS REFERENCE

Mfgs. No.	Our No.	Mfg. Code	Mfgs. No.	Our No.	Mfg. Code	Mfgs. No.	Our No.	Mfg. Code	Mfgs. No.	Our No.	Mfg. Code	Mfgs. No.	Our No.	Mfg. Code
2403076	M120365	TYLR	2430273	P207349	STMC	2450060CP	P207300	DFLX	24757	J024757	AP	250007741	M080024	SLAR
2403077	M120197	TYLR	2430277	P207350	STMC	2450724	P206333	STMC	24758	J024758	AP	250009843	X004539	SLAR
2403144	M100465	TYLR	2430278	P207351	STMC	2450726	P206334	STMC	248280	M090301	SLAR	250010865	M120131	SLAR
2403151	M090544	TYLR	2430283	P207352	STMC	2450727	P206334	STMC	2482970	M090544	GM	250024779	M100016	SLAR
2403184	M085207	TYLR	2430286	P207353	STMC	2450728	P206335	STMC	2482972	M100048	GM	250024780	P270543	SLAR
2403359	M085078	TYLR	2430301	P207354	STMC	2450729	P206336	STMC	248337	J009649	ALSY	250024CP	P224589	HDMI
2403518	M100572	TYLR	2430492	P207353	STMC		P206336	CRMY		J009649	FRAM	250030884	M100146	SLAR
2403666	P206614	TYLE	2430493	P207354	STMC	2450730	P206336	STMC	24835	J024835	TRUX	2500355	P206405	DMT
2403714	P207419	TYLR	2430613	P216169	STMC	2450732	P206337	STMC		J024835	AP		P206405	SYNER
2403783	M065073	TYLR	2430614	P207353	STMC	2450736	P206337	STMC	24836	J024836	AP	2500357	P206407	DMT
2404031	M085023	TYLR	2430618	P207354	STMC	2451261	P226140	STMC		J024836	TRUX		P206407	SYNER
240806	M080024	SLAR	2430621	P216169	STMC	2451282	P206338	STMC	24837	J024837	AP	2500361	P206411	DMT
241260	X004484	SLAR	24344	P206309	TRUX	2460048	P216197	DFLX		J024837	TRUX		P206411	SYNER
241415	X004482	SLAR		P206309	AP	2460048AZ	P216197	DFLX	2483764	M100048	GM	2500362	P207667	DMT
2419264	X007784	CAT	24345	P206310	TRUX	24609	P206547	HAVA	24838	J024838	AP		P207667	SYNER
2419265	X007785	CAT		P206310	AP	24658	P206547	TRUX		J024838	TRUX	250048	P206379	HDMI
241970	P226144	SLAR	24346	J024748	TRUX		P206547	AP	24850	J024850	AP	250048A	P206379	HDMI
242029	X004480	SLAR	24347	P206312	TRUX	24672	P206305	AP		J024850	TRUX	250048CP	P206389	HDMI
24205	P206301	TRUX		P206312	AP		J024747	TRUX	2485787	M085023	GM	250060	P208393	HDMI
2421143	J014623	STMC	2435018	P207281	DFLX	24675	P206552	TRUX	2488074	M065065	GM	250060A	P208393	HDMI
2421144	P207309	STMC	2435018AZ	P207281	DFLX	24676	P206553	TRUX	2488076	M085023	GM	250060CP	P206391	HDMI
2421281	P206384	STMC	2435024	J024735	DFLX	24677	P206554	TRUX	248888	M085056	FMCO	2500638	P206604	STMC
2421282	P207308	STMC	2435036	P208348	DFLX	24678	P206555	TRUX	24908	M080018	WILM	2500639	J009613	STMC
2421283	P206385	STMC	2435036AZ	P208348	DFLX	24696	P207559	AP		M080018	AGEM	2500640	P206606	STMC
2421285	P216200	STMC	2435048	P207286	DFLX	24697	P207419	GOE	24921330	M085023	GRDL	2500900	P206604	STMC
	P216200	WLKR	2435048AZ	P207286	DFLX		P207419	AP		M085023	WRNR	2500901	P206605	STMC
2421286	P208359	STMC	24400	P205976	HDMI	24697Q	P207419	AP	24938	P224633	TRUX	2500930	J009612	STMC
2421287	J034746	STMC	2440001	P207411	STMC	24708	P208328	AP	24939	P208338	TRUX	2500931	P206607	STMC
2421288	P208375	STMC	2440018	P207282	DFLX	24709	P208336	AP	24941	P216191	TRUX	2500970	P213191	STMC
2421289	P216204	STMC	2440024	J024737	DFLX	24710	P207281	AP	24MP50036CP	P216227	DFLX	2501017	P210110	STMC
2421291	P207319	STMC	2440024R91	M085008	NAVI	24711	P207282	TRUX	24MP50048CP	P216228	DFLX	2501102	P270543	SYNER
2421292	P206386	STMC	2440036	P208364	DFLX	24712	P207282	AP	24P30024	P208328	DFLX	2501153	P206341	SYNER
2421293	P207320	STMC	2440036AZ	P208364	DFLX	24712	P207283	TRUX	24P30024AZ	P208328	DFLX		P206341	DMT
2421294	P206387	STMC	2440048	P207287	DFLX		P207283	AP	24P30036	P206376	DFLX	2501164	P206340	SYNER
2421295	P207321	STMC	2440048AZ	P207287	DFLX	24713	P207297	GOE	24P30036AZ	P206376	DFLX		P206340	SYNER
2421296	P208389	STMC	2440060	P207288	DFLX		P207297	AP	24P30048	P206376	DFLX	250118CP	P224703	HDMI
2421297	P207301	STMC	2440060AZ	P207288	DFLX	24714	P207297	TRUX	24P30048AZ	P206376	DFLX	250136CP	P216227	HDMI
2421298	P208395	STMC	2440060CP	P207299	DFLX		P207298	AP	24P35024	P208326	DFLX	250148CP	P216228	HDMI
2421299	P207302	STMC	244007R91	M085023	NAVI	24715	P207308	AP	24P35024AZ	P208336	DFLX	250160CP	J540008	HDMI
2421300	J640005	STMC	2440191	P206367	STMC	24716	P207309	AP	24P35036	P208324	DFLX	2501710	M090538	CLRK
2421301	P216202	STMC	2440192	P206368	STMC	24717	P207309	AP	24P35048	P206377	DFLX	250172CP	P224609	HDMI
2421302	P224600	STMC	2440200	P206369	STMC	24717	P208386	AP	24P35048AZ	P206377	DFLX	2501775	P206301	DIND
2421303	P216205	STMC	2440204	P206370	STMC		P208386	TRUX	24P40018CP	P208385	DFLX	2501787	P207397	DIND
2421305	P224635	STMC	2440602	P207411	STMC	24718	P208392	TRUX	24P40024	J240012	DFLX	2501803	M090170	VLVO
2421307	P224638	STMC	2440753	P207411	STMC		P208392	AP	24P40048	P206378	DFLX		M090170	CLRK
2421308	P209913	STMC	2440754	P206366	STMC	24719	P208330	AP	24P40048CP	P206388	DFLX	2503736	M060480	DIND
2421310	P209912	STMC	2440755	P206369	STMC	24720	P208338	AP	24P40060CP	P206390	DFLX	2503737	P206306	DIND
2421311	P209910	STMC	2440756	P206370	STMC	24721	P206384	AP	24P40072	J640001	DFLX	2503776	M060158	DIND
2421317	P224636	STMC	2440758	P207413	STMC	24722	P206385	AP	24P40096CP	P206391	DFLX	2503777	M002117	DIND
2421402	J024749	STMC	2440762	P206367	STMC	24731	P216191	TRUX	24P50048	P206379	DFLX	25048810	M090074	MAK
2421403	J024757	STMC	2440763	P206368	STMC	24735	J024735	TRUX	24P50048AZ	P206379	DFLX	2505781	X004484	PNJK
2421404	J024751	STMC	2444889	M065065	GM		J024735	AP	24P50048CP	P206389	DFLX	25069983	M100043	MAK
2421405	J024758	STMC	244511	P206282	XAIR	24737	J024737	TRUX	24P50060	P208393	DFLX	2508001	J009614	STMC
242367	M120225	SLAR	2445PE	P207353	XAIR		J024737	AP	24P50060AZ	P208393	DFLX	25084209	M085171	MAK
2423714	M085023	GM	2446593	M110028	CAT	24739	J024739	TRUX	2500001	J009611	STMC	25092	M001327	CRMY
2426018	P207559	STMC	244951001	X007824	VMER		J024739	AP	2500002	P210110	STMC	2509461	M100146	JJI
24270004	M060037	SCRM	2449510011	X007824	VMER	24745	P224633	TRUX		P210110	DMT		M100146	PNJK
24270006	M100016	SCRM	24500	P206300	HDMI	24746	J024746	AP	2500003	P270534	SYNER	2510883	M090210	CLRK
2427177	M065065	GM	2450001	P206331	STMC		J024746	TRUX		J009612	STMC		M090159	ECLD
2427277	M085023	GM	2450003	P206333	STMC	24747	J024747	TRUX	2500006	J009611	STMC	2511251	M085090	PNJK
2428242	M065065	GM	2450004	J000127	STMC		J024747	AP	2500007	P270538	SYNER	25114233	X004480	BNTA
2430001	P207349	STMC	2450018	P207283	DFLX	24748	J024748	AP		P270538	DMT	251210	M090072	CUMS
2430002	P207347	STMC	2450018AZ	P207283	DFLX		J024748	TRUX	2500012	P270543	SYNER	251211	M090074	CUMS
2430004	P207350	STMC	2450024	J024739	DFLX	24749	J024749	AP		P270543	DMT	2512224	M170101	VLVO
2430024	P216191	DFLX	2450024AZ	J024739	DFLX	24750	J024750	AP	2500016	J009613	STMC	2513322	X004484	ECLD
2430024AZ	P216191	DFLX	2450036	P208380	DFLX	2475010	P224412	CAT	2500017	P222018	WLKR	251601	X004539	MOXY
2430036	P208324	DFLX	2450036AZ	P208380	DFLX	2475011	M002134	CAT	2500020	J009618	STMC	25175546	J190059	AMC
2430036AZ	P208324	DFLX	2450048	P207292	DFLX	24751	J024751	AP		J009618	STMC		J190059	XMN
2430048	P207285	DFLX	2450048AZ	P207292	DFLX	24754	J024754	TRUX	2500021	J009612	WLKR	251765	P206607	MOXY
2430048AZ	P207285	DFLX	2450048CP	P207317	DFLX		J024754	AP	2500022	P222018	WLKR	251766	P206607	MOXY
2430048CP	P207314	DFLX	2450060	P207289	DFLX	24755	J024755	AP		P222018	STMC	2519859	M120189	CLRK
2430263	P207347	STMC	2450060AZ	P207289	DFLX		J024755	TRUX	2500023	P222018	WLKR		M120189	TREX
									250004198	P206405	VANAI	2520560	M070068	VME

(See first page of this section for Manufacturer's Code Listing)

Mfgs. No.	Our No.	Mfg. Code	Mfgs. No.	Our No.	Mfg. Code	Mfgs. No.	Our No.	Mfg. Code	Mfgs. No.	Our No.	Mfg. Code	Mfgs. No.	Our No.	Mfg. Code
	M070068ECLD	2550005J008942STMC	25P20012P206306DFLX		M080024STMC		J009623WSTI
2520844P206388STMC	2550018AZP207298DFLX	25P25012P206308DFLX	2621064M090091STGR	2681545J190062STMC
2520845P206390STMC	2550018CPP207309DFLX	25P30012P206309DFLX		M090091STMC	2681550J009624STMC
2520847P206389STMC	2550024J024747DFLX	25P30012AZP206309DFLX	2621065M100016STMC	2681560J190063STMC
2520848P206391STMC	2550024CPJ024758DFLX	25P30024P208330DFLX	262190P208366	..VANAIR	2681830X007833STMC
252293M065034FRAM	2550048P207296DFLX	25P30024AZP208330DFLX	2622015M060038STMC	2681835X007834STMC
	M065034ALSY	2550048AZP207296DFLX	25P30048P206380DFLX	2622020M060037STMC	2681840X007824STMC
252317P206410EMSN	2550048CPP207321DFLX	25P30048AZP206380DFLX	2622025M065030STMC	2681850X007805STMC
2527050M120108VLVO	2550060CPP207302DFLX	25P30048CPP207312DFLX	2622030M070068STMC	2681925X007829STMC
2528407M090159ECLD	2550072CPP216205DFLX	25P35012P206310DFLX	2622035M070069STMC	2681927X004538STMC
	M090159VLVO	2550096CPP209910DFLX	25P35012AZP206310DFLX	2622040M080024STMC	2681930X007830STMC
2530012P206302DFLX	2550145P207389STMC	25P35024P208338DFLX	2622050M090091STMC	2681935X007831STMC
2530012AZP206302DFLX	2550152P206324STMC	25P35024AZP208338DFLX	2622060M100016STMC	2681940X007784STMC
2530036P208326DFLX	2550157P206325STMC	25P35048P206381DFLX	2623030M070068STMC	2681950X007785STMC
2530036AZP208326DFLX	2550162P206327STMC	25P35048AZP206381DFLX	26355AP207568HDMI	2681960X009076STMC
2530048P207293DFLX	2550168P206328STMC	25P40018P206311DFLX	263574M065030FMCO	2682425X004476STMC
2530048AZP207293DFLX	255026P226157XAIR	25P40018P208386DFLX		M065030NH	2682430X004478STMC
2530048CPP207318DFLX	2550898P207386STMC	25P40018AZP208386DFLX	264387001M045193VMER	2682435X004480STMC
2530189P207295STMC	2550902P207402STMC	25P40018CPP206384DFLX	265445M060037NH	2682450X004484STMC
2530193P208350WLKR	2550903P206324STMC	25P40024J024748DFLX		M060037FMCO	2682460X004539STMC
	P208350STMC	2550929M120100CHLR	25P40024CPJ024749DFLX	266223M080024NH	2682840P222748STMC
2530198P208366STMC	255119X004480KOHL	25P40036P208358DFLX	26623M080024FMCO		X007784CRMY
253026P226140XAIR	25530140M085078DMAG	25P40036AZP208358DFLX		M080024VSTL	2682845P222749STMC
2530468P207296STMC		M085078MH	25P40036CPP208359DFLX	26624M090091FMCO	2682850P222750STMC
2530894P207290STMC		M085078KTSU	25P40048P206382DFLX		M090091VSTL	2682940X004482STMC
2530976J024746STMC	25530240P206309KTSU	25P40048AZP206382DFLX	2672155M065065FMC	2682950P222759STMC
2530977J024747STMC	25530340P206407KTSU	25P40048CPP206386DFLX	2672157M085008FMC	2682960X004539STMC
2531093P208350STMC	2554030P206326STMC	25P40060P208388DFLX	2672158M085023PRLP	2683331000M170101PRLP
2531311M120189VLVO	25558740M085056MH	25P40060AZP208388DFLX		M085023FMC	26834P207282CRMY
253191P270536KOHL		M085056DMAG	25P40060CPP208389DFLX	2672159M100048FMC	2683520J000210STMC
253237M085090KOHL		M085056KTSU	25P40060CPP208389DFLX	2672160M090544PRLP	2683522J000212STMC
253265M085056KOHL	255651P207408FRAM	25P50018P208392DFLX		M090544FMC	2683525J000211STMC
2534018P207297STMC		P207408ALSY	25P50018AZP208392DFLX	2679303M090074FMC	2683527J000213WLKR
	P207297WLKR	2558162P206322STMC	25P50018CPP206385DFLX		M090074PRLP	2683530J000214WLKR
2535012P206303DFLX	2558168P206323STMC	25P50024J024750DFLX	2680001X004536STMC		X004478STMC
2535036P206328DFLX	255L21P206328SPRT	25P50024CPJ024751DFLX	2680002X004537WLKR	2683535J000215STMC
2535036AZP208350DFLX	2560002P206361STMC	25P50036P208374DFLX		X004537STMC	2683540J000216STMC
2535036CPP216200DFLX	2560024AZP207559DFLX	25P50036AZP208374DFLX	2680003X004476WLKR	2683545J000219STMC
2535048CPP207319DFLX	2560036P216206DFLX	25P50036CPP208375DFLX		X004476STMC	2683550J000217STMC
2535072P224709STMC	2560036AZP216206DFLX	25P50048P206383DFLX	2680004X004538WLKR	2683560J000218STMC
253526P226154XAIR	256017C91M100052NAVI	25P50048AZP206383DFLX		X004538STMC	2683630J000214WLKR
25358571M060037IR	2560635P206362STMC	25P50048CPP206387DFLX	2680005X004478STMC		J000214STMC
2536036P216206WLKR	2560636P206363STMC	25P50060P208394DFLX	2680006X004480WLKR	2683635J000215STMC
	P216206STMC	2560637P206364STMC	25P50060AZP208394DFLX		X004480STMC		J000215WLKR
253614M100146KOHL	2560752P206365STMC	25P50060CPP208395DFLX	2680007X004482WLKR	2683640J000216WLKR
253990P270539KOHL	2570199P206617STMC	25P50072P224600DFLX		X004482STMC		J000216STMC
2540012P206304DFLX	2580994P206641STMC	25P50072P224600DFLX	2680008X004484WLKR	2683650J000217WLKR
2540012CPJ014623DFLX	2581172P206334STMC	25P50096CPP209912DFLX		X004484STMC		J000217STMC
2540018P207297DFLX	2585714C1J000216NAVI	25P60024AZP207419DFLX	2680009X004539WLKR	2683660J000218WLKR
2540018AZP207282DFLX	2585715C1J000217NAVI	25PLSJ190058ACFT		X004539STMC		J000218STMC
2540018CPP207308DFLX	2585716C1J009605NAVI	25T1520M080018PH	2681135X006204WLKR	2684040J000202WLKR
2540024J024746DFLX	2585717C1J009606NAVI	260024P206336TESSI	2681140X006203STMC		J000202STMC
2540024CPJ024757DFLX	2585718C1J009607NAVI	26020222P206411TDYN	2681150X006202WLKR	2684050J000203WLKR
2540036P208366DFLX	2585719C1J009623NAVI		P206411GEDY		X006202STMC		J000203STMC
2540036AZP208366DFLX	2585720C1J009624NAVI	26020231P206555GEDY	2681430J009604STMC	268590960X007824SAME
2540036CPJ034746DFLX	2585721C1J190061NAVI		P206555TDYN	2681435J009605STMC	2686840P222748STMC
2540048P207295DFLX	2585723C1M090534NAVI	26020232X007785TDYN	2681440J009606STMC	2690018M120365PRLP
2540048AZP207295DFLX	2585724C1M090535NAVI		X007785GEDY	2681445J190054STMC	2690019M170101PRLP
2540048CPP207320DFLX	2585725C1M090544NAVI	260382P206279	..VANAIR		J190054WLKR	2690035P206394STMC
2540060P207290DFLX	2585726C1M090680NAVI	260424V11M045237FMCO	2681450J009607STMC	2690040P206395STMC
2540060AZP207290DFLX	2585727C1M100465NAVI		M045237VSTL	2681460J190055WLKR	2690044P206396STMC
2540060CPP207301DFLX	2585728C1M100695NAVI	2609013P206601VMER		J190055STMC	2690046000M080018PRLP
2540072CPP216202DFLX	2585729C1M110189NAVI	261315P270539SLAR	2681520J190056STMC	269505067P206338VMER
254026P226155XAIR	2585735C1P206410NAVI		P270539	..VANAIR		J190056WLKR	269509400P206350DMAG
25404P206617HDMI	2585736C1P206411NAVI	2614907BM045237BORG	2681522J190057STMC		P206350MH
2545814P206283XAIR	2585737C1P226158NAVI	2615509M001867CAT		J190057WLKR		P206350KTSU
25458PEP207354XAIR	2585746C1X006202NAVI	2621058M060038STMC	2681525J190058STMC	26951040P207419KTSU
254621001J000206VMER	2585747C1X006203NAVI	2621059M060037STMC		J190058STMC		P207419MH
25497948M100213MACK	2585748C1X007805NAVI	2621060M065030STMC	2681527J190059WLKR		P207419DMAG
2550001P207394STMC	25971800P270534JCB	2621061M070068STMC		J190059STMC	26951140P207596KTSU
2550002P206321STMC	25E5TJ000211ACFT		M070068STGR	2681530J190060STMC		P207596MH
2550003P207402STMC	25H0218M120154LBX	2621062M070069STMC	2681535J190061STMC		P207596DMAG
							M070069STGR	2681540J009623STMC			
						2621063M080							

Cross Reference

(See first page of this section for Manufacturer's Code Listing)



CROSS REFERENCE

Mfgs. No.	Our No.	Mfg. Code	Mfgs. No.	Our No.	Mfg. Code	Mfgs. No.	Our No.	Mfg. Code	Mfgs. No.	Our No.	Mfg. Code	Mfgs. No.	Our No.	Mfg. Code	
2695850	X007805	STMC	2745180	H001032	CLRK	27Z438	M085056	PH	28R15	M100464	BABR	29323305	P270531	MRBR	
26S12	X004480	BABR	2745578M1	M070069	MF		M085056	CTRY	290109040	X004482	PCFE	29323306	P270532	MRBR	
2700608	P270534	DIND	274578M1	M070069	MF	27Z459013	M090072	PH	290109050	X004484	PCFE	29323307	P270533	MRBR	
2700747	P270532	FEDR		M070069	AGCO	27Z53206	M080024	PH	29035	X005207	WLKR	29323308	P270534	MRBR	
	P270532	DIA	274650	P270543	KOHL	27Z641	M065065	PH	29038	P206543	WLKR	29323310	P270536	MRBR	
	P270532	DIND	27500CP	P270838	DFLX	27Z651	M120154	TREX	29041	P206543	WLKR	29323311	P270538	MRBR	
2703272	J008681	DIND	27500Z	P270541	DFLX		M120154	PH	29042	P206540	WLKR	29323312	P270539	MRBR	
27039	H001034	CRMV	27550Z	P270542	DFLX		M120154	CTRY	29043	J009429	WLKR	29323313	P270540	MRBR	
2704	M085023	GOE	27600CP	P271511	DFLX	27Z738D2	X004478	CTRY	29044	J009429	WLKR	29323314	P270541	MRBR	
	M085023	APE	27600Z	P270543	DFLX		X004478	TREX	29045	P206543	WLKR	29323316	P270543	MRBR	
	M085023	TRUX	276254	P270532	KOHL	27Z738D4	X004482	CTRY	29051	J009429	WLKR	29323464	J000227	MRBR	
	M085023	AP	277177C91	M090534	NAVI		X004482	PH	29053	J009429	WLKR	29323467	J000228	MRBR	
2704Q	M085023	AP	277494001	J009636	VMER	27Z738D5	X004484	CTRY	29059	J009429	WLKR	29323469	J000230	MRBR	
2705036	P216227	STMC	27824	H001039	URLG		X004484	PH	2907822	M100048	CHLR	29323663	P206322	MRBR	
2705048	P216228	STMC	2797478	M065073	CLRK	27Z739	M090170	PH		M100048	CLRK	29323665	J009648	MRBR	
2705060	J540008	STMC	27EST	J000213	ACFT	27Z799	M085078	CTRY	2909336	M090544	CHLR	29323666	M120154	MRBR	
27055	P207368	XAIR	27PLS	J190059	ACFT		M085023	PH	29101	P206384	WLKR	29323731	P270534	MRBR	
27065940	P206411	MH	27Q160	M120365	CTRY	27Z948D1	M120365	PH	29102	P206385	WLKR	29323757	P206324	MRBR	
	P206411	DMAG	27Q206	M100464	PH	280082	P205976	TESSI	29105	P216169	WLKR	29323761	P206325	MRBR	
	P206411	KTSU	27Q224	M100146	PH	2804158	P206408	VLVO	29107	P206375	WLKR	29323762	P206326	MRBR	
27076530	M090538	VLVO		M100146	CTRY	28136620	X006203	AJMC	29108	J190004	WLKR	29323765	P207394	MRBR	
27076531	M100464	VLVO		M100146	TREX	28136720	X006202	AJMC	29109	P207345	WLKR	29323782	J024758	MRBR	
27076535	M120197	WGMC	27Q241	M090091	TREX	28137220	X004478	AJMC	29110	P206641	WLKR	29323797	P208324	MRBR	
27076541	M120100	WGMC		M090091	PH	28137420	X004482	AJMC	29111	P207308	WLKR	29323799	J024737	MRBR	
27076542	M120365	VLVO	27Q288D1	M120235	PH	28137520	X004484	AJMC	29112	P207309	WLKR	29323803	P206280	MRBR	
27076544	M090072	WGMC		M120235	CTRY	2831025	M090544	CHLR	29113	P206285	WLKR	29323804	P207352	MRBR	
27076560	X004480	VLVO	27Q334	M100048	CTRY	283249A1	M001756	CASE	29118845	M060158	MRBR	29323809	J009640	MRBR	
27076626	X004476	VSTI		M100048	TREX	283389001	M100048	VMER	29121	J190019	WLKR	29323810	P207353	MRBR	
	X004476	VLVO		M100048	PH	283393001	P206322	VMER	29129	P207346	WLKR	29323812	P206283	MRBR	
27076627	X004478	VLVO	27Q389	M120225	PH	283395001	P206369	VMER	29200	P206286	WLKR	29323851	P207362	MRBR	
270825	X004476	HSTR		M120225	CTRY	283396001	J008681	VMER	29201	J024749	WLKR	29323852	P207363	MRBR	
	X004476	NACO		M120225	TREX	283397001	J009644	VMER	29202	J024751	WLKR	29323853	P207364	MRBR	
270826	X004478	HSTR	27Q429	M120131	CTRY	283398001	P207330	VMER	29206	J024757	WLKR	29323856	P207363	MRBR	
270827	X004480	NACO		M120131	PH	283463001	P206546	VMER	29207	J024758	WLKR	29323857	P206398	MRBR	
	X004480	HSTR	27Q564	M190002	PH	283466001	P206364	VMER	29208	P224692	WLKR	29323859	P207330	MRBR	
27138775	M100146	VLVO	27Q582D2	X004482	PH	283474001	P206346	VMER	29210	J009547	WLKR	29323862	P207365	MRBR	
27138776	M090091	VLVO	27Q582D3	X004484	CTRY	28350A	P206313	HDMI	29211	P206353	WLKR	29323863	P207322	MRBR	
27150Z	P270530	DFLX		X004484	PH	28353	P206314	HDMI	29212	J009547	WLKR	29323864	P207324	MRBR	
2715120	P224707	STMC	27Q582D4	X004539	PH	28353A	P206314	HDMI	29213	J240024	WLKR	29323865	P207361	MRBR	
27175Z	P270531	DFLX	27Q590	M090535	PH	28375A	P207386	HDMI	29220	P206286	WLKR	29323867	P207326	MRBR	
2720002	J009560	STMC	27Q598	M090301	PH	284106	P226151	GTMN	29228324	M002121	MRBR	29323869	P207327	MRBR	
2720068	J009560	WLKR	27Q600	M100146	CTRY	28430	P206315	HDMI	29228349	M101169	MRBR	29323870	P206346	MRBR	
27200Z	P270532	DFLX		M100146	PH	28430A	P206315	HDMI	292289001	P270530	VMER	29323872	P206348	MRBR	
2720500	J009637	STMC	27Q639	M090072	PH	28435	P206316	HDMI	29300	P224698	WLKR	29323876	P216175	MRBR	
	J009637	WLKR		M090072	CTRY	28435A	P206316	HDMI	29301	P216227	WLKR	29323877	P207366	MRBR	
2722400	J009640	WLKR	27Q686	M085090	PH	284428001	M090781	VMER	29304	P216200	WLKR	29323878	P207341	MRBR	
27225Z	P270533	DFLX	27Q690	M140048	PH	284431001	J009518	VMER	29305	J034746	WLKR	29323881	P207333	MRBR	
27250Z	P270534	DFLX	27Q695	M100213	PH	28528	J028528	AP	29306	P216204	WLKR	29323890	P206339	MRBR	
27275Z	P270535	DFLX	27Q713	M090535	PH		J028528	TRUX	29307	P208359	WLKR	29323892	P206342	MRBR	
2730046	P206633	STMC	27Q761D1	P206311	PH	28540	P206317	HDMI	29308	P208375	WLKR	29323893	P206342	MRBR	
27300CP	P271507	DFLX	27Q7621D1	M090544	PH	28540A	P206317	HDMI	293120081	M001327	CETCO	29323894	P206344	MRBR	
27300Z	P270536	DFLX	27Q762D1	M090544	PH	28650	P206318	HDMI	29321335	J000216	MRBR	29323896	J008681	MRBR	
2730322	J009479	STMC	27Q82	M090210	TREX	28650A	P206318	HDMI	29323029	M060037	MRBR	29323897	P207339	MRBR	
2730324	P207353	STMC		M090210	PH	28656	X004482	AGEM	29323030	M065030	MRBR	29323899	P206347	MRBR	
27350CP	P271508	DFLX		M090210	CTRY		X004482	WILM	29323031	M065030	MRBR	29323901	P206309	MRBR	
27350Z	P270538	DFLX	27T1520	M080018	CTRY	28658	P207297	AGEM	29323033	M070068	MRBR	29323917	P206302	MRBR	
2740020	J028528	STMC		M080018	PH		P207297	WILM	29323036	M070069	MRBR	29323930	J009644	MRBR	
2740070	P207332	STMC	27U126	M100463	PH	287816001	P207351	VMER	29323039	M080024	MRBR	29323932	P207335	MRBR	
27400CP	P270837	DFLX	27U215	M090535	PH	287895001	P207353	VMER	29323041	M090091	MRBR	29323934	P206397	MRBR	
27400Z	P270539	DFLX	27Z1	M070008	TREX		P207353	CMWK	29323048	M100016	MRBR	29323948	P207349	MRBR	
2740121	J018110	STMC		M070008	PH	287945001	P270532	VMER	29323061	M090594	MRBR	29323956	P206367	MRBR	
2740126	P224710	STMC	27Z1115	M100048	PH	287951001	P270541	VMER	29323062	M120365	MRBR	29323961	P206370	MRBR	
2740127	P224641	STMC		M100048	CTRY	288113	X004536	NACO	29323072	M085090	MRBR	29323980	J190045	MRBR	
2740128	P224711	STMC		M100048	CTRY		X004536	HSTR	29323078	M090072	MRBR	29328890	P206339	MRBR	
2740148	J038612	STMC	27Z17	M090009	KOEH	2892492	X009076	CAT	29323080	M085407	MRBR	29350A	P206324	HDMI	
2740150	J038611	STMC		M090009	PH	28961	X004484	EIMC	29323081	M085208	MRBR	29353	P206325	HDMI	
2740165	P206283	STMC	27Z260	M085008	PH	28A1475	M100463	FMC	29323084	M065044	MRBR	29353A	P206325	HDMI	
2740172	P207365	STMC		M085008	PH		M100463	LKBT	29323089	M090009	MRBR	29375A	P207386	HDMI	
2740183	J009633	STMC	27Z285	M090544	PH		M100463	LKBT	29323090	M190002	MRBR	29400	P206388	WLKR	
2740201	P224581	STMC	27Z338	M120100	PH	28H0448	M070069	FMC	29323094	M065074	MRBR	29401	P206389	WLKR	
2740201	P224581	STMC	27Z354	M120225	PH	28H0696	M120365	LKBT	29323095	M122300	MRBR	29402	P206386	WLKR	
27404	P206616	HDMI	27Z378	M085023	PH	28H1012	M120225	LKBT	29323304	P270530	MRBR	29403	P206387	WLKR	
2744636	M002122	CAT	27Z393	M120100	PH		M120225	FMC							
27450Z	P270540	DFLX		M120100	CTRY	28H448	M070069	FMC							

(See first page of this section for Manufacturer's Code Listing)

Mfgs. No.	Our No.	Mfg. Code	Mfgs. No.	Our No.	Mfg. Code	Mfgs. No.	Our No.	Mfg. Code	Mfgs. No.	Our No.	Mfg. Code	Mfgs. No.	Our No.	Mfg. Code
29405.....	P216228 ...	WLKR	29900.....	P224636 ...	WLKR	2ME378.....	M100049 ...	MACK	3012605614.....	P216175AST	303556.....	P207353TYLE		
29408.....	P207320 ...	WLKR	2990392.....	M085056CAT		2ME384.....	M090091 ...	MACK		P216175 ...ASTEC	303583.....	J000230.....BOSS		
29409.....	P207321 ...	WLKR	2991610.....	J009640STMC		2ME38482.....	M100016 ...	MACK	3014051362.....	M170101AST	303587.....	J000227.....BOSS		
29410.....	P207314 ...	WLKR	2991735.....	J009632STMC		2ME384P2.....	M100016 ...	MACK		M170101 ...ASTEC	303768.....	P206507TYLE		
29415.....	P207317 ...	WLKR	299456A1.....	P206600KBCO		2ME384P3.....	M080024 ...	MACK	3014051363.....	P207366AST	303991400.....	P206399BOSS		
29430.....	P206326 ...	HDMI		P206600CASE		2ME395.....	M085171 ...	MACK		P207366 ...ASTEC	304050.....	M060251BOSS		
29430A.....	P206326 ...	HDMI	2994719M1.....	X004482HNMG		2ME395A.....	M085171 ...	MACK	3014051442.....	P207667AST	304052.....	P206306BOSS		
29435.....	P206327 ...	HDMI	29A430.....	P206321HDMI		2ME399.....	M090544 ...	MACK		P207667 ...ASTEC	304066.....	M065140BOSS		
29435A.....	P206327 ...	HDMI	29A430A.....	P206321HDMI		2ME49301.....	M090544 ...	MACK	3014052031.....	P207341AST	304067.....	M085409BOSS		
29500.....	P206390 ...	WLKR	29A435.....	P206322HDMI		2ME49301P11.....	M100465 ...	MACK		P207341 ...ASTEC	304068.....	P206308BOSS		
29501.....	P206391 ...	WLKR	29A435A.....	P206322HDMI		2ME49301P2.....	M100465 ...	MACK	3014052056.....	M090595AST	304069.....	P206309BOSS		
29502.....	P208389 ...	WLKR	29A540.....	P206323HDMI		2ME49301P3.....	M100465 ...	MACK		M090595 ...ASTEC	304070.....	M002118BOSS		
29503.....	P208395 ...	WLKR	29A540A.....	P206323HDMI		2ME49301P4.....	M100465 ...	MACK	3014052240.....	P207354 ...ASTEC	304071.....	M002119BOSS		
29506.....	P207299 ...	WLKR	29A650A.....	P207402HDMI		2ME49301P5.....	M100463 ...	MACK		P207354 ...AST	304254.....	P207283TYLE		
29507.....	P207300 ...	WLKR	29H77.....	M100048 ...BABR		2ME49301P6.....	M090535 ...	MACK	3014052260.....	P206283 ...ASTEC	304605066.....	P206341 ...ASTEC		
29508.....	P207301 ...	WLKR	29L16.....	M065071 ...BABR		2ME49301P7.....	M100465 ...	MACK		P206283 ...AST		P206341AST		
29509.....	P207302 ...	WLKR	2MD236.....	M120108 ...MACK		2ME49601P7.....	M100465 ...	MACK	3014052313.....	P207324AST	304605097.....	M085090AST		
29510.....	P209912 ...	WLKR	2MD337AP3.....	M090280 ...MACK		2MEX328.....	M120100 ...	MACK		P207324 ...ASTEC		M085090 ...ASTEC		
29511.....	J540008 ...	WLKR	2ME153.....	M080024 ...MACK					3014052592.....	P207335AST	30495.....	M070008KSHA		
29512.....	P224641 ...	WLKR	2ME229.....	M090009 ...MACK						P207335 ...ASTEC	305367.....	P207326BOSS		
29540.....	P206328 ...	HDMI	2ME235.....	M170101 ...MACK					3016051005.....	M190002 ...ASTEC	305605056.....	M085208 ...ASTEC		
29540A.....	P206328 ...	HDMI	2ME236.....	M120108 ...MACK						M190002 ...AST		M085208AST		
2955550.....	M085008 ...	CHLR	2ME236P1.....	M100463 ...MACK					3016377.....	M120365 ...CUMS	30600A.....	P207414HDMI		
29600.....	P216202 ...	WLKR	2ME236P2.....	M120365 ...MACK					3018051102.....	M120418 ...ASTEC	3061656.....	M085023 ...ACMS		
29603.....	P216205 ...	WLKR	2ME236P3.....	M120225 ...MACK						M120418 ...AST	3061668.....	M085023 ...ACMS		
29604.....	P224600 ...	WLKR	2ME247.....	M090091 ...MACK					3018051104.....	P207328 ...ASTEC	306245027.....	M080018AST		
29605.....	J640005 ...	WLKR	2ME248.....	M100463 ...MACK						P207328 ...AST		M080018 ...ASTEC		
2962280907.....	M091048 ...	VMER	2ME251.....	M085171 ...MACK					301999.....	M090362 ...BOSS	306245029.....	P206340AST		
296274651.....	M091050 ...	VMER	2ME29301P1.....	M100465 ...MACK					3024020.....	P226156 ...XAIR		P206340 ...ASTEC		
296277847.....	M091046 ...	VMER	2ME29301P12.....	M100464 ...MACK					302402018.....	P206554 ...XAIR	306245030.....	P207351 ...ASTEC		
296277910.....	X007834 ...	VMER	2ME29301P13.....	M100465 ...MACK					302423.....	P270539 ...BOSS		P207351 ...AST		
296280907.....	M091048 ...	VMER	2ME29301P14.....	M100465 ...MACK					302423080.....	P270532 ...BOSS	306245151.....	P270539 ...ASTEC		
296318775.....	P207361 ...	VMER	2ME29301P17.....	M100463 ...MACK					300639.....	X006203 ...BOSS		P270539AST		
29650.....	P207394 ...	HDMI	2ME29301P18.....	M100463 ...MACK					300639200.....	X004536 ...BOSS	306245207.....	M100048 ...AST		
296505065.....	J000232 ...	VMER	2ME29301P19.....	M100463 ...MACK					300639250.....	X004476 ...BOSS		M100048 ...ASTEC		
296505066.....	P206607 ...	VMER	2ME29301P20.....	M100463 ...MACK					300639300.....	X004478 ...BOSS	306245262.....	M100572 ...AST		
296505067.....	P206338 ...	VMER	2ME29301P21.....	M090072 ...MACK					300639350.....	X006204 ...BOSS		M100572 ...ASTEC		
29650A.....	P207394 ...	HDMI	2ME29301P22.....	M100465 ...MACK					30077.....	M110077 ...HDMI	306245264.....	P206546 ...ASTEC		
29701.....	P224638 ...	WLKR	2ME29301P23.....	M100464 ...MACK					300914.....	P206282 ...BOSS		P206546 ...AST		
29702.....	P224635 ...	WLKR	2ME29301P24.....	M100464 ...MACK					300914350.....	P206281 ...BOSS	306245433.....	P206410AST		
2974081.....	M085008 ...	CHLR	2ME29301P25.....	M100464 ...MACK					300914400.....	P206282 ...BOSS		P206410 ...ASTEC		
2975915.....	M085023 ...	CHLR	2ME29301P6.....	M090535 ...MACK					300915.....	P206340 ...BOSS	306605183.....	P206326 ...ASTEC		
2976411M91.....	H001033 ...	HNMG	2ME29302.....	M120131 ...MACK					300915300.....	P206340 ...BOSS		P206326AST		
2977819M91.....	H001032 ...	HNMG	2ME29302.....	M120131 ...MACK					300915350.....	P206342 ...BOSS	306942.....	P207363 ...CMWK		
2980009147.....	M206407 ...	CMI	2ME3102.....	M090781 ...MACK					300915400.....	P206344 ...BOSS	306945.....	P207364 ...CMWK		
29801.....	P209910 ...	WLKR	2ME3104.....	M100580 ...MACK					300A1014.....	P206334AP	306945A.....	P206398 ...CMWK		
2980508392.....	M085008 ...	RXRD	2ME3104P3.....	M100582 ...MACK					300A1016.....	P206334 ...TRUX	307099.....	P216206 ...FOREM		
2980518292.....	P206374 ...	CMI	2ME3104P5.....	M100582 ...MACK						P206334 ...AP		H001034 ...HNMG		
2980518392.....	M090538 ...	REX	2ME3106A.....	M120566 ...MACK					300A1216.....	P206334AP	307335.....	X007833 ...BOSS		
	M090538 ...	CMI	2ME3112.....	M120713 ...MACK					300A1414.....	P206334AP	307345.....	P206544 ...BOSS		
2980518592.....	M100464 ...	RXRD	2ME3118.....	M090823 ...MACK					300K1014.....	P206334AP	307577.....	M060481BOSS		
2980518692.....	M085023 ...	RXRD	2ME3118A.....	M090823 ...MACK						P206334 ...DFLX	307578.....	P206515 ...BOSS		
2980519892.....	M060232 ...	RXRD	2ME3119.....	M100213 ...MACK					3010305004.....	M122300 ...ASTEC	307708.....	M085411 ...BOSS		
	M060232 ...	MIIN	2ME3132M.....	M101181 ...MACK						M122300 ...AST	30781.....	M090781 ...HDMI		
2980522392.....	P207330 ...	CMI	2ME3136M.....	M090074 ...MACK					3010305074.....	P207324 ...ASTEC	30805333.....	M090009 ...TRES		
2980526297.....	P206612 ...	MIIN	2ME3339.....	M090544 ...MACK						P207324 ...AST	30805L1106.....	M120365 ...ASTEC		
2980527892.....	P270541 ...	CMI	2ME335AP2.....	M090280 ...MACK					3010605136.....	P206346AST		M120365AST		
2980528892.....	P206280 ...	MIIN	2ME336B.....	M085171 ...MACK						P206346 ...ASTEC	30805L1107.....	P207365 ...ASTEC		
2980532692.....	J009606 ...	CMI	2ME336P2.....	M120365 ...MACK					3010845017.....	M120108 ...ASTEC		P207365AST		
2980533392.....	P206603 ...	CMI	2ME337AP2.....	M090158 ...MACK						M120108 ...AST	30805L1280.....	P207339 ...ASTEC		
2980535392.....	J190063 ...	CMI	2ME337AP3.....	M090534 ...MACK					3010845019.....	P207332 ...ASTEC		P207339AST		
2980535892.....	P207332 ...	CMI	2ME361P3.....	M120382 ...MACK						P207332 ...ASTEC	30805L1368.....	P206411AST		
2980535992.....	P207596 ...	CMI	2ME361P5.....	M120382 ...MACK					3012605022.....	P206282 ...AST		P206411 ...ASTEC		
2980536192.....	P206318 ...	CMI	2ME366.....	M090074 ...MACK						P206282 ...ASTEC	308486.....	P206350 ...FOREM		
298053692.....	P206318 ...	CMI	2ME371.....	M100464 ...MACK					3012605231.....	P206603 ...ASTEC	3093978.....	P226152CAT		
29806.....	P209913 ...	WLKR	2ME372.....	M090538 ...MACK						P206603 ...AST	309540.....	P206553 ...TYLE		
29807.....	P209912 ...	WLKR	2ME373.....	M100464 ...MACK					3012605258.....	P270541 ...AST	309541.....	P206398 ...TYLE		
29808392.....	M085008 ...	REX	2ME374.....	M090535 ...MACK						P270541 ...ASTEC	309542.....	J190014 ...TYLE		
298510192.....	M080018 ...	REX	2ME374P1.....	M090535 ...MACK					3012605289.....	P207402 ...ASTEC		J190014 ...CASE		
	M080018 ...	RXRD	2ME374P2.....	M090535 ...MACK						P207402 ...AST	309543.....	P206342 ...TYLE		
298517292.....	M120100 ...	REX	2ME375.....	M090544 ...MACK					3012605321.....	P206603 ...AST	3095893.....	M101158 ...VLVO		
2987580M91.....	P270542 ...	HNMG	2ME376.....	M100464 ...MACK						P206603 ...ASTEC	3095900.....	M101182 ...VLVO		
			2ME377.....	M100043 ...MACK					3012605356.....	P206603 ...AST				

CROSS REFERENCE

Cross Reference

(See first page of this section for Manufacturer's Code Listing)



CROSS REFERENCE

Mfgs. No.	Our No.	Mfg. Code	Mfgs. No.	Our No.	Mfg. Code	Mfgs. No.	Our No.	Mfg. Code	Mfgs. No.	Our No.	Mfg. Code	Mfgs. No.	Our No.	Mfg. Code
3095906	M101181	VLVO	31086	M070050	HDMI	31234	M140048	HDMI	31514	M090781	HDMI	322035	M090158	JLGI
309605013	P206281	ASTECC	31096	M085171	HDMI	31235	M060481	HDMI	3154065R91	P270531	FURU	3224136	M100580	OKSH
	P206281	AST	31102	M085090	HDMI	31237	M085206	HDMI		P270531	DRSS		M100580	MNLS
309605014	P206409	ASTECC	31104	M085056	HDMI	31238	M090301	HDMI	3154070R91	P270535	FURU	32250	P206371	DFLX
	P206409	AST	311061	X004484	STGR	31241	M060250	HDMI		P270535	DRSS	322622	M090594	FOREM
309605333	P206323	ASTECC	31107	M085080	HDMI	31242	M065073	HDMI	31558	P207352	WLKR	322656	P208392	U C
	P206323	AST	31109	M090362	HDMI	31243	M085207	HDMI	31566	M120566	HDMI	3227Q16D1	M090091	CTRY
309605337	P208380	ASTECC	31112	M090009	HDMI	31245	M060251	HDMI	31580	M100580	HDMI	3227Q03	M120235	KOEHL
	P208380	AST	31119	M090544	HDMI	31246	M065074	HDMI	31582	M100582	HDMI		M120235	CTRY
309605366	P207330	AST	31123	M090280	HDMI	312461780	P206410	AGCC	31584	M085084	HDMI	3227Z25	M065030	CTRY
	P207330	ASTECC	31125	M090159	HDMI		P206410	WHITE	31600	P207414	DFLX	32305	M090301	CRMY
30AA	J000200	ACFT	31126	M090170	HDMI	31247	M085208	HDMI	31600A	P207408	HDMI	32343	P206363	CRMY
30EL45101A	P206280	ACFT	31127	M090538	HDMI	31248	M090598	HDMI	31680	M090680	HDMI	3234765	M090544	OKSH
30EL45200A	P207351	ACFT	31129W	M090210	HDMI	31249	M100572	HDMI	316977	P207282	TYLE		M090544	MNLS
30EL90111A	P206340	ACFT	31136	M090301	HDMI	31250	M120418	HDMI	31805003703	M001756	SDMO	32350	P206373	DFLX
30EL90112A	P206341	ACFT	31139	M100052	HDMI	31251	M060247	HDMI	31805003704	M001702	SDMO	3235459R1	M120154	NAVI
30EL90211A	P207326	ACFT	31141	M090594	CMI	31252	M090594	HDMI	31805003705	M001502	SDMO		M120154	CUCC
30EL90212A	J190013	ACFT	3114118101	P206340	CMI	31253	M090595	HDMI	31805003710	M001703	SDMO	32381080	P207397	ASTECC
30EL90239A	P207362	ACFT	3114118201	P206326	CMI	312625830	H001284	WHITE	318141	J008681	TYLE		P207397	AST
30EL90240A	P206397	ACFT	3114118401	P207330	CMI	312626	P206516	TENT	318142	J024737	TYLE	324207	M065044	KOHL
30EST	J000214	ACFT	3114118601	P270539	CMI	312627	J008167	TENT	319404	P206346	RDRL	32441	P206321	AGEM
30FBC	P206608	ACFT	3114119201	P206540	CMI	31280	M090280	HDMI	31A300	P206362	HDMI	324601	P270541	KOHL
30FBZ	P206600	ACFT	3114119301	P206511	CMI	31293	M085293	HDMI	31A300A	P206362	HDMI	324937C1	M090534	NAVI
30GZ	P206407	ACFT	31142	M100146	HDMI	31295	P206540	TENT	31A350	P206363	HDMI	324937C91	M090280	NAVI
30HD	J000227	ACFT	31143	M110143	HDMI	312968	P206510	TENT	31A350A	P206363	HDMI	32500	P206375	DFLX
30PLA	J009604	ACFT	311432	X004478	CASE	312A1016	P206335	TRUX	31A400	P206364	HDMI	3252257M91	M060037	HNMGM
30PLS	J190060	ACFT	31148	M100464	HDMI		P206335	AP	31A400A	P206364	HDMI	32564204391	M120235	KOEHL
30RCZ	P270536	ACFT	31149	M100464	HDMI	312K1014	P206335	AP	31A500	P206365	HDMI	32564206302	M120131	KOEHL
30STA120	P206334	ACFT	31150	M100213	HDMI		P206335	TRUX	31A500A	P206365	HDMI	3256420V4391	M120235	KOEHL
30TS112A	P206302	ACFT	311593170	M100049	WHITE	312S1016	P224685	TRUX	31AS400	P206364	HDMI	32600	P207408	DFLX
30TS212A	P206309	ACFT	31163	M100807	HDMI	31300	P206367	DFLX	31AS400A	P206364	HDMI	3262770	M070008	SNBL
31001518	M120108	BLNT	31164	M100466	HDMI		P206372	HDMI	31AS500	P206365	HDMI	3279482	X006202	OKSH
	M120108	CAT	31165	M100465	HDMI	31300A	P206372	HDMI	31AS500A	P206365	HDMI		X006202	AMFGI
310017	P270838	TESSI	31166	M100466	HDMI	313015	P206540	TENT	31H0104	M100043	FMC	327Q690	M140048	PH
31002	M060232	HDMI	311685010	M070068	AGCC	3130888	P206328	VLVO		M100043	LKBT	32821	X004478	AGEM
31002486	P216172	CAME		M070068	WHITE	3130889	P206387	VLVO		M100043	LBX		X004478	WILM
31004	M065065	HDMI	31173	M120135	HDMI	3130890	P206405	VLVO	31L400	P206369	DFLX	32822	P226144	AGEM
31005070	M120108	CAME	31179	M120154	HDMI	3130891	P206407	VLVO	31L500	P206370	DFLX	3282957	X006203	CUMS
31015	M085023	HDMI	31181	M120131	HDMI	3130892	P206410	VLVO	31L600	P207414	DFLX	3283435	P206553	CUMS
31018	M085008	HDMI	311816010	H001279	DETT	3130893	P206411	VLVO	31S400	P206374	HDMI	3283436	X004480	CUMS
31019	M085080	HDMI		H001279	AGCC	3130894	P206507	VLVO	31S400A	P206374	HDMI	32C65	P207281	BABR
31020	M090544	HDMI		H001279	WHITE	3130895	P206555	VLVO	31S500	P206375	HDMI	32H0511	M120197	LKBT
31021	M090074	HDMI	31183	M120135	HDMI	3130896	J024838	VLVO	31S500A	P206375	HDMI	32H511	M120197	FMC
31022	M090544	HDMI	31189	M110189	HDMI	3130897	P206601	VLVO	320014	P206606	TESSI	32L300	P206372	DFLX
31023	M090535	HDMI	311890	P206543	TENT	3130898	P206602	VLVO	320015	P213191	TESSI	32L350	P206373	DFLX
31024	M090072	HDMI	311891	P206508	TENT	3130899	P206603	VLVO	320037	J009614	TESSI	32L400	P206374	DFLX
31025	M090146	HDMI	31191	M120235	HDMI	3130900	P206607	VLVO	320110	X004476	TESSI	32L500	P206375	DFLX
31026	M090158	HDMI	31197	M122300	HDMI	3130901	P206611	VLVO	320111	X004538	TESSI	32L600	P207408	DFLX
31028	M110028	HDMI	31199	M120225	HDMI	3130902	P207339	VLVO	320112	X004478	TESSI	32Z2631	P206411	PH
31031	M100048	HDMI	31200	M120131	HDMI	3130903	P208375	VLVO	320114	X004482	TESSI		P206411	CTRY
31032	M100049	HDMI		P207411	DFLX	3130904	P208395	VLVO	320115	X004484	TESSI	32Z27X52	X004484	PH
31034	M065034	HDMI	31202	M120382	HDMI	3130905	P270541	VLVO	320116	X004536	TESSI		X004484	CTRY
31035	M120365	HDMI	31204	M120197	HDMI	313094	J000224	DYPC	320117	X004537	TESSI	3300	P207362	XAIR
31036	M120100	HDMI	31209	M170101	HDMI	3131441	P206347	FRTL	320123	X004539	TESSI		P207362	HDMI
31037	M120108	HDMI	31211	M190002	HDMI	3131445	P206383	VLVO	320287	P206342	ARV	330006004	X004478	FDEN
31038	M080018	HDMI	31211062	X004484	KOEHL	31350	P206368	DFLX	320289	P206344	ARV	330007	P206410	TESSI
31043	M100043	HDMI		X004484	CAME		P206373	HDMI	321007255	H001278	NH	330027	P206611	TESSI
31045	M100695	HDMI		X004484	BOMA	31350A	P206373	HDMI		H001278	CASE	330036	P208326	HDMI
310484800	J000204	ATCC	31211063	X004539	KOEHL	313592	M001668	TYLE		H001278	FIAT	330036A	P208326	HDMI
31063	M100463	HDMI		X004539	CAME	31367	M120367	HDMI	321852150	H001284	NH	3300391R91	M120189	SEDD
310689	M001702	TYLE	31212	M085189	HDMI	313712	P207351	TENT		H001284	CASE	330048	P207293	HDMI
310690	P270539	TYLE	31214	M090547	HDMI	31400	P206374	HDMI		H001284	FIAT	330048A	P207293	HDMI
31074	M045237	HDMI	31215	M090548	HDMI	31400A	P206374	HDMI	32200	P207405	DFLX	330048CP	P207318	HDMI
31075	M045193	HDMI	31218	M120366	HDMI	31407	M085407	HDMI	3220009	M060038	JLGI	330124	P208330	HDMI
31076	M065071	HDMI	31223	M085172	HDMI	31479	M110479	HDMI	3220010	M065030	JLGI	330124A	P208330	HDMI
31077	M060005	HDMI	31224	M100463	HDMI	3150	M085189	TRUX	3220033	M045237	JLGI	330124CP	J240016	HDMI
31078	M085078	HDMI	312241	J009648	TENT		M085189	AP	3220035	M090158	JLGI	330148	P206380	HDMI
31080	M060158	HDMI		J009648	GRVE		M085189	GOE	3220036	M060037	JLGI	330148A	P206380	HDMI
31081	M065044	HDMI	31225	M090534	HDMI	31500	P206375	HDMI	3220039	M090210	JLGI	330148CP	P207312	HDMI
31082	M060055	HDMI	31226	M090563	HDMI	31500A	P206375	HDMI	3220049	M100048	JLGI	33065	P207329	WILM
31083	M090823	HDMI	31227	M090563	HDMI	31500C	M085189	AP	3220076	M045123	JLGI		P207329	AGEM
31084	M070008	HDMI	31230	M110012	HDMI	315120C91	M100052	NAVI	3220079	M085409	JLGI	33160445	P207394	MJPR
31085	M070028	HDMI	31231	M110014	HDMI							33170013	P206317	MJPR

(See first page of this section for Manufacturer's Code Listing)

CROSS REFERENCE

Mfgs. No.	Our No.	Mfg. Code	Mfgs. No.	Our No.	Mfg. Code	Mfgs. No.	Our No.	Mfg. Code	Mfgs. No.	Our No.	Mfg. Code	Mfgs. No.	Our No.	Mfg. Code
33170018	M090535	MJPR	33314	P222750	WLKR	340124CP	J024749	HDMI	34718	M085056	ERIC	350172A	P224600	HDMI
33170026	M090823	MJPR	33315	P222751	WLKR	340136	P208358	HDMI	34719	P208366	TRUX	350172CP	P224600	HDMI
33170033	M100048	MJPR	33323	P222746	WLKR	340136A	P208358	HDMI		P208366	AP	350196CP	P209912	HDMI
33170039	M085409	MJPR	33324	P222747	WLKR	340136CP	P208359	HDMI	34720	P216204	TRUX	3501A	P208392	HDMI
33170049	P206540	MJPR	33325	P222748	WLKR	340148	P206382	HDMI	34721	M070068	ERIC	3501CP	P206385	HDMI
33170050	P206543	MJPR	33327	P222750	WLKR	340148A	P206382	HDMI	34723	M060055	ERIC	35036	P222018	WLKR
33170099	M100043	MJPR	33328	P222751	WLKR	340148CP	P206386	HDMI		P208358	AP	350503	X004484	WGNR
33170108	M090535	MJPR	333476C91	M090072	NAVI	340160	P208388	HDMI		P208358	TRUX	35097	X004482	CRMY
33170150	P226143	MJPR	3334818	P206515	CAT	340160A	P208388	HDMI	34724	P208374	TRUX	35100015	P206511	MJPR
33170406	P206615	MJPR	33400	P206297	DFLX	340160CP	P208389	HDMI		P208374	AP	35100016	P206509	MJPR
33170407	P206607	MJPR	3350	P207363	XAIR	340172CP	J640005	HDMI	34727	P208359	AP	35100202	X004482	MJPR
33170408	P206400	MJPR	33500	P206298	DFLX	340189	P206555	SCNA	34728	P208375	AP	35100203	X004539	MJPR
33170409	P207354	MJPR	33500109	J000228	PERK	340190	J024838	SCNA	34743	J034743	TRUX	35100210	X004484	MJPR
33170411	P207402	MJPR	335024A	P224633	HDMI	340196CP	P209913	HDMI		J034743	AP	35100506	P206512	MJPR
33170413	P206350	MJPR	335036	P208350	HDMI	34028	M060232	BRLEE	34744	J034744	TRUX	351012	X004480	WGNR
33170414	P2070543	MJPR	335036A	P208350	HDMI		M060232	RSCO		J034744	AP		X004480	ATCO
33170419	P226150	MJPR	335036CP	P216200	HDMI	340283	M060158	BRLEE	34746	J034746	AP	35103	P206507	WLKR
33170424	P207394	MJPR	335048CP	P207319	HDMI		M060158	RSCO	34747	M065065	ERIC	35107192	M065065	IR
33170426	P206345	MJPR	335124	P208338	HDMI	34074	M065044	BRLEE	348022	M065034	FMC	35109107	M120100	IR
33170428	P206321	MJPR	335124A	P208338	HDMI	34110	M060037	ERIC	348025	M065030	FMC	35111731	P206410	IR
33170447	P206323	MJPR	335148	P206381	HDMI	34112	M045237	ERIC	348027	M090594	FMC	35113530	M085023	IR
33170483	P206375	MJPR	335148A	P206381	HDMI		P222748	WLKR	34818	M065044	WILM	35113539	M085023	IR
33170487	M080024	MJPR	33576	P270538	BRLEE	34128	M085056	ERIC		M065044	AGEM	35113646	P206407	IR
33170508	M120235	MJPR		P270538	RSCO	34137	P206363	CRMY	34825	J240004	TRUX		P206407	IRCR
33200	J000220	WLKR	335A	P207363	HDMI	34191	M060055	ERIC	34827	P208350	TRUX	351170	X004478	WGNR
33212	J000221	WLKR	3377215R1	P270538	FURU	34229	M060038	ERIC	34828	P206380	TRUX		X004478	ATCO
33214	J000222	WLKR		P270538	DRSS	34233	M065034	ERIC	34830	P224581	TRUX	35164	P270542	WLKR
33220	X007829	WLKR	3377344R1	P270536	FURU	342578	M120100	PACC	34831	P224582	TRUX	35194	P270539	WLKR
33221	J190059	WLKR		P270536	FURU	3426003	M065030	EIMC	34853	M090158	ERIC	35195	P270541	WLKR
33222	X007830	WLKR	338614C1	J009613	NAVI	3426023	M065030	EIMC	34862	M045237	RSCO	352025	P207382	DFLX
33223	J190061	WLKR	33958	J000211	WLKR	3426049	M100146	LGMF	34880	M090170	ERIC	35225	P270530	WLKR
33224	X007784	WLKR	33959	J000214	WLKR	3426403	M065030	EIMC	34892	P207389	CRMY	35226	P270531	WLKR
33225	X007785	WLKR	33960	J000215	WLKR	34335	P226156	AGEM	3494639	M080018	HSTR	35227	J000202	WLKR
33226	X007829	WLKR	33961	J000216	WLKR	34335A	P226156	AGEM	34957	M065065	CRMY	35228	J000203	WLKR
33227	J190059	WLKR		P206393	CMPPR	34370	M065065	ERIC	3500	P207365	XAIR	352530	P206313	DFLX
33228	P222752	WLKR		P206393	LROI	34453	M120154	ERIC		P207365	HDMI	35290	P222018	WLKR
33231	J190057	WLKR	33962	J000217	WLKR	3454640	P206409	MNTW	350001	P207784	TESSI	35291	X006204	WLKR
33239	M065034	RSCO	33963	J000218	WLKR	345481	X004539	MNTO	350011	P206511	TESSI	35292	X006203	WLKR
	M065034	BRLEE	33964	J000213	WLKR	3454810	X004539	MNTW	350018	P207298	HDMI	35293	X006202	WLKR
33240	P222753	WLKR	33967	X007833	WLKR	345507	X004484	MNTO	350018A	P207298	HDMI	35293059	X004478	IRCR
3324009	P270534	CAT	33968	X007834	WLKR	3455070	X004484	MNTW	350018CP	P207309	HDMI		X004478	IR
3324011	M065071	CAT	33969	J009606	WLKR		X004484	GRVE	350024	J024747	HDMI	35293067	X004480	IR
33241	P222754	WLKR	33970	J009607	WLKR	345512	P206337	U C	350024A	J024747	HDMI	35294305	X004478	IR
33244	P222744	WLKR	33973	P207353	CMPPR	345525	P207339	U C	350024CP	J024758	HDMI	35296060	X004476	IR
33245	P222745	WLKR		P207353	LROI	3455300	X004482	MNTW	350036CP	P216204	HDMI	353035	P206314	DFLX
33246	P222752	WLKR	33993	P206507	TRUX	3455300	X004482	MNTW	350048	P207296	HDMI	353035AZ	P206314	DFLX
33248	P222753	WLKR	3400	P207364	XAIR	3455530	P206512	GRVE	350048A	P207296	HDMI	35304	P206405	WLKR
33249	P222754	WLKR		P207297	HDMI		P206512	MNTW	350048CP	P207321	HDMI	353040	P206315	DFLX
33264	P222755	WLKR	340005	J240004	AP	3455970	X004480	MNTW	35006	X004480	TMPO	353040AZ	P206315	DFLX
33266	P222757	WLKR	3400108CP	P224636	HDMI	34587	M085078	ERIC	350060CP	P207302	HDMI	35304310	M090146	IR
33268	P222759	WLKR	340018A	P207297	HDMI	34589	H001032	ERIC	350072A	P224709	HDMI	35307131	X004482	TKNG
33272	X007830	WLKR	340023	J340023	AP	3459884	M085023	CHLR		P224709	HDMI		X004484	IR
33273	X007831	WLKR	340024	J024746	HDMI	34667	M065030	CRMY	350072CP	P216205	HDMI		X004482	IRCR
33274	X007784	WLKR	340024A	J024746	HDMI	34673	J034673	AP	350084CP	P224638	HDMI	35313303	X004484	TKNG
33275	J190062	WLKR	340024CP	J024757	HDMI		J034673	TRUX	350096CP	P209910	HDMI		X004484	IRCR
33276	X007785	WLKR	340036	P208366	HDMI	34674	J034674	AP	3500A	P207298	HDMI		X004482	IR
33278	P222755	WLKR	340036A	P208366	HDMI		J034674	TRUX	3500CP	P207309	HDMI	35325	P222748	WLKR
33279	P222756	WLKR	340036CP	J034746	HDMI	34679	X004476	RSCO	350118	P208392	HDMI	35328871	X004536	IR
33280	P222757	WLKR	340048A	P207295	HDMI		X004476	BRLEE	350118A	P208392	HDMI	35335	J000220	WLKR
33281	P222758	WLKR	340048CP	P207320	HDMI	34682	M065034	ERIC	350118CP	P206385	HDMI	35336	J000222	WLKR
33282	P222759	WLKR	340060A	P207290	HDMI	34691	M090210	ERIC	350124	J024750	HDMI	35337	J000221	WLKR
33285	J009605	WLKR	340060CP	P207301	HDMI	34709	P206376	AP	350124A	J024750	HDMI	3535382	P207596	OKSH
33288	X007805	WLKR	340060LA	P224710	HDMI	34713	P208324	AP	350124CP	J024751	HDMI	35354	J000221	WLKR
33293	X007824	WLKR	340060LCP	P224641	HDMI		P208324	TRUX	350136	P208374	HDMI	353540	P206316	DFLX
33294	X007805	WLKR	340072CP	P216202	HDMI	34714	P208348	AP	350136A	P208374	HDMI	353540AZ	P206316	DFLX
33300	J000227	WLKR	340084CP	P224635	HDMI		P208348	TRUX	350136CP	P208375	HDMI	35358571	M060037	IR
33304	J000230	WLKR	3400A	P207297	HDMI	34715	P208364	TRUX	350148	P206383	HDMI	35369120	M090009	MNTW
33305	J000232	WLKR	3400CP	P207308	HDMI		P208364	AP	350148A	P206383	HDMI	35371	P205834	WLKR
33310	P222746	WLKR	340118	P208386	HDMI	34716	P208380	AP	350148CP	P206387	HDMI	35373	J000231	WLKR
33311	P222747	WLKR	340118A	P208386	HDMI		P208380	TRUX	350160	P208394	HDMI	35392	P271511	WLKR
33312	P222748	WLKR	340118CP	P206384	HDMI	34717	P208326	AP	350160A	P208394	HDMI	35393	P270543	WLKR
33313	P222749	WLKR	340124	J024748	HDMI		P208326	GOE	350160CP	P208395	HDMI	35401	J009612	WLKR
			340124A	J024748	HDMI	34717Q	P208326	AP	350172	P224600	HDMI	354050	P206317	DFLX

Cross Reference

(See first page of this section for Manufacturer's Code Listing)



CROSS REFERENCE

Mfgs. No.	Our No.	Mfg. Code	Mfgs. No.	Our No.	Mfg. Code	Mfgs. No.	Our No.	Mfg. Code	Mfgs. No.	Our No.	Mfg. Code	Mfgs. No.	Our No.	Mfg. Code	
354050AZ.....	P206317.....	DFLX	35776.....	P206610.....	WLKR	35932.....	P270838.....	WLKR			M070068.....			M090280.....	TRUX
35408.....	J000220.....	WLKR	35777.....	P206611.....	WLKR	35933.....	P206512.....	WLKR	3612153.....	P270532.....	FIAT			M090280.....	GOE
35409.....	P207667.....	WLKR	35778.....	P206616.....	WLKR	35934.....	X004478.....	WLKR		P270532.....	CASE	3632066M1.....	X004484.....	AGCO	
35413.....	J000222.....	WLKR	35786.....	P206407.....	WLKR	35935.....	P206512.....	WLKR	3612157.....	P270541.....	FIAT	36323277.....	M065044.....	IR	
35414.....	J000221.....	WLKR	35787.....	P206409.....	WLKR	35936.....	X004480.....	WLKR		P270541.....	CASE	3632Q.....	M090280.....	AP	
354170.....	X004482.....	WGNR	35788.....	P206410.....	WLKR	35937.....	X004482.....	WLKR	3612162.....	M120197.....	FIAT	3633.....	M090159.....	AP	
	X004482.....	ATCO	35789.....	P206411.....	WLKR	35938.....	X004484.....	WLKR		M120197.....	CASE	3633Q.....	M090159.....	AP	
35423.....	J000219.....	WLKR	35790.....	P206511.....	WLKR	35939.....	X004539.....	WLKR	3612171.....	M100043.....	FIAT	3634.....	M090210.....	AP	
35424.....	J000231.....	WLKR	35791.....	P206512.....	WLKR	359696A1.....	M001503.....	CASE		M100043.....	FIAT	3634560.....	M090544.....	CHLR	
35433.....	P271507.....	WLKR	35792.....	P206512.....	WLKR	35972.....	P206518.....	WLKR	3612177.....	M060251.....	CASE	3634620.....	M120131.....	CHLR	
35444.....	P206608.....	WLKR	35793.....	J000224.....	WLKR	35973.....	P207345.....	WLKR		M060251.....	FIAT	3634Q.....	M090210.....	AP	
35445.....	P206408.....	WLKR	35794.....	J000227.....	WLKR	35974.....	P207346.....	WLKR	3612180.....	M065074.....	FIAT	36352672.....	M045193.....	IR	
35449.....	P206604.....	WLKR	35795.....	J000233.....	WLKR	35975.....	J000217.....	WLKR		M065074.....	CASE	363540.....	P206322.....	DFLX	
35456.....	J009486.....	WLKR	35796.....	P207784.....	WLKR	35976.....	J000216.....	WLKR	3612182.....	M120365.....	FIAT	363540AZ.....	P206322.....	DFLX	
354562.....	P270534.....	KOHL	35797877.....	M090210.....	IR	35977.....	J000215.....	WLKR		M120365.....	CASE	3636.....	M090301.....	TRUX	
35457.....	J009487.....	WLKR	35800.....	P206602.....	WLKR	35978.....	J000214.....	WLKR	3614.....	M120100.....	AP		M090301.....	AP	
354612.....	M120131.....	ATCO	35804.....	P206603.....	WLKR	35979.....	J000211.....	WLKR		M120100.....	TRUX		M090301.....	GOE	
	M120131.....	WGNR	35804.....	P206605.....	WLKR	35980.....	J000218.....	WLKR	36145.....	P206403.....	WLKR	3636Q.....	M090301.....	AP	
35494.....	J009613.....	WLKR	35805.....	P206606.....	WLKR	35983.....	P206519.....	WLKR	36146.....	P206404.....	WLKR	3637.....	M100146.....	TRUX	
35495.....	J009611.....	WLKR	35806.....	P206607.....	WLKR	35984.....	P206521.....	WLKR	36147.....	P206406.....	WLKR		M100146.....	AP	
35496.....	J009613.....	WLKR	35807.....	M060038.....	WLKR	35988.....	P207308.....	WLKR	36148.....	P222744.....	WLKR		M100146.....	GOE	
35497.....	P207598.....	WLKR	35829944.....	M090535.....	IR	35989.....	P207309.....	WLKR	36149.....	P222745.....	WLKR	3637Q.....	M100146.....	AP	
35498.....	J009614.....	WLKR	35844117.....	M085056.....	IR	35997.....	P206353.....	WLKR	3614Q.....	M120100.....	AP	3638397.....	M090074.....	CHLR	
35499.....	P210110.....	WLKR	35852.....	P206524.....	WLKR	35997.....	P206353.....	WLKR	3615.....	M060055.....	AP	363881.....	M002121.....	FOREM	
35500.....	P213191.....	WLKR	35853.....	P206525.....	WLKR	35AA.....	J000201.....	ACFT	3615Q.....	M060055.....	AP	3640.....	M100463.....	TRUX	
3550036CP.....	P216204.....	DFLX	35854.....	P206515.....	WLKR	35EL90114A.....	P206342.....	ACFT	3616.....	M090170.....	GOE		M100463.....	GOE	
355060.....	P206318.....	DFLX	35855.....	P206516.....	WLKR	35EL90115A.....	P206343.....	ACFT		M090170.....	AP		M100463.....	AP	
355060AZ.....	P206318.....	DFLX	35856.....	P206517.....	WLKR	35EL90214A.....	J190014.....	ACFT	3616Q.....	M090170.....	AP	364050.....	P206323.....	DFLX	
35512.....	P270532.....	WLKR	3587471.....	M111026.....	OKSH	35EL90215A.....	P207328.....	ACFT	3617.....	M045193.....	AP	364050AZ.....	P206323.....	DFLX	
35513.....	P270533.....	WLKR	35886.....	P206510.....	WLKR	35EL90241A.....	P206398.....	ACFT		M045193.....	GOE	3640908.....	M100464.....	CHLR	
35514.....	P270534.....	WLKR	35887.....	P206511.....	WLKR	35EST.....	J000215.....	ACFT	3617Q.....	M045193.....	AP	3640Q.....	M100463.....	AP	
35514629.....	M085084.....	IR	358921C1.....	M090280.....	NAVI	35FBC.....	P206609.....	ACFT	3618.....	M070028.....	AP	3641507.....	M002122.....	OKSH	
35539238.....	P270534.....	IR	35898.....	J008167.....	WLKR	35FBZ.....	P206601.....	ACFT		M070028.....	HDMI	3643.....	M120176.....	AP	
35576271.....	M085090.....	IR	35899.....	P224841.....	WLKR	35GZ.....	P206409.....	ACFT		M070028.....	GOE	3643Q.....	M120176.....	AP	
35584499.....	M120131.....	IR	35907.....	P270539.....	WLKR	35HD.....	J000228.....	ACFT		M070028.....	TRUX	364406.....	M170101.....	FOREM	
35595834.....	M070068.....	IR	3590812.....	M100049.....	HRSN	35P2530.....	J190042.....	DFLX	3618Q.....	M070028.....	AP	364443.....	P222751.....	FOREM	
35598934.....	M070068.....	IR	3590813.....	M090535.....	HRSN	35P3035.....	J190044.....	DFLX	3620.....	M120108.....	AP	3645.....	M120235.....	TRUX	
35606.....	P206523.....	WLKR	3590814.....	M100464.....	HRSN	35P3040.....	J009648.....	DFLX	3620Q.....	M120108.....	AP		M120235.....	AP	
356153C1.....	M090072.....	NAVI	3590815.....	M120131.....	HRSN	35P3540.....	J190045.....	DFLX	362025.....	P207397.....	DFLX	3645Q.....	M120235.....	AP	
35617.....	P270535.....	WLKR	3590816.....	M090544.....	HRSN	35P4050.....	J009649.....	DFLX	3620Q.....	M120108.....	AP	3646.....	M122300.....	AP	
35618.....	P270536.....	WLKR	3590823.....	M090544.....	HRSN	35P5060.....	J009650.....	DFLX	3621.....	M065071.....	AP	3646Q.....	M122300.....	AP	
35619.....	P270538.....	ROSS	3590824.....	M090534.....	HRSN	35PLA.....	J009605.....	ACFT	3621Q.....	M065071.....	GOE	3647.....	M120108.....	TRUX	
	P270538.....	WLKR	3590825.....	M100464.....	HRSN	35PLS.....	J190061.....	ACFT	3622.....	M060158.....	AP		M120225.....	AP	
35620.....	J000210.....	WLKR	3590826.....	M090544.....	HRSN	35RCZ.....	P270538.....	ACFT	3622Q.....	M060158.....	AP		M120225.....	GOE	
35621.....	J000212.....	WLKR	3590827.....	M085023.....	HRSN	35STA120.....	P206335.....	ACFT	3624.....	M065034.....	TRUX	3647Q.....	M120225.....	AP	
35622.....	J000213.....	WLKR	3590829.....	M090538.....	HRSN	35TS112A.....	P206303.....	ACFT		M065034.....	GOE	3648.....	M120131.....	AP	
35624.....	P206600.....	WLKR	3590831.....	M100043.....	HRSN	35TS212A.....	P206310.....	ACFT		M065034.....	AP	3648Q.....	M120131.....	AP	
35636.....	J009618.....	WLKR	3590834.....	M100464.....	HRSN	35X30R303A.....	P206314.....	ACFT	362455.....	M140048.....	FOREM	3649.....	M170101.....	AP	
35660.....	J009479.....	WLKR	3590837.....	M100463.....	HRSN	3600.....	P207361.....	XAIR	362467.....	P207596.....	FOREM	3649Q.....	M170101.....	AP	
35673022.....	M060005.....	JAGR	3590838.....	M120176.....	HRSN	360001.....	P206543.....	TESSI	3624Q.....	M065034.....	AP	3650.....	M190002.....	AP	
35673580.....	M070008.....	JAGR	3590841.....	M090091.....	HRSN	360014.....	P206508.....	TESSI	3625.....	M085171.....	GOE	36506Q.....	P207402.....	DFLX	
35673585.....	M070050.....	JAGR	3590842.....	M100465.....	HRSN	360015.....	P206509.....	TESSI		M085171.....	AP	365060AZ.....	P207402.....	DFLX	
356808.....	P208388.....	FOREM	3590844.....	M100464.....	HRSN	3610.....	M090563.....	TRUX		M085171.....	TRUX	3650Q.....	M190002.....	AP	
35690.....	J009612.....	WLKR	3590845.....	M100464.....	HRSN		M090563.....	GOE	362530.....	P206319.....	DFLX	3653.....	M085421.....	TRUX	
35692.....	P207598.....	WLKR	3590846.....	M120197.....	HRSN	3610Q.....	M090563.....	AP	3625Q.....	M085171.....	AP	3654.....	M065065.....	AP	
35693.....	P207596.....	WLKR	3590850.....	M090072.....	HRSN	3611.....	M090520.....	GOE	3626.....	M085084.....	TRUX		M065065.....	APE	
35694.....	P206609.....	WLKR	3590853.....	M120365.....	HRSN		M090520.....	AP		M085090.....	AP		M065065.....	GOE	
35696.....	P206601.....	WLKR	3590855.....	M120108.....	HRSN		M090520.....	TRUX		M085090.....	GOE		M065065.....	TRUX	
35733.....	P206520.....	WLKR	3590856.....	M100463.....	HRSN	3611Q.....	M090520.....	AP		M085090.....	TRUX	3654Q.....	M065065.....	AP	
35734.....	P206526.....	WLKR	3590861.....	M100146.....	HRSN	3612111.....	M090158.....	CASE	3626Q.....	M085090.....	AP	3655.....	M085023.....	TRUX	
35746.....	P210110.....	WLKR	3590863.....	M100463.....	HRSN		M090158.....	FIAT	3627.....	M085056.....	AP	3662.....	M085008.....	APE	
35749.....	J000232.....	WLKR	3590868.....	M100463.....	HME	3612123.....	M065044.....	CASE		M085056.....	TRUX		M085008.....	AP	
35752.....	J000230.....	WLKR		M100463.....	HRSN		M065044.....	FIAT		M085056.....	AP		M085008.....	GOE	
35753.....	J000228.....	WLKR	359087.....	M120154.....	HRSN	3612125.....	M120100.....	FIAT		M085056.....	AP	3662Q.....	M085008.....	TRUX	
35757.....	J000232.....	WLKR	359089.....	M090544.....	HRSN		M120100.....	CASE	3629.....	M085078.....	AP		M085008.....	AP	
35758.....	J000231.....	WLKR	35909.....	P270540.....	WLKR	3612127.....	P270538.....	FIAT	3629Q.....	M085023.....	AP	366303C1.....	M090146.....	NAVI	
35760.....	P206408.....	WLKR	35910.....	P270541.....	WLKR		P270538.....	CASE	36300100.....	P206518.....	MJPR	3664.....	M090544.....	AP	
357686A1.....	X009076.....	CASE	35924.....	X004536.....	WLKR	3612136.....	P270533.....	CASE	363035.....	P206320.....	DFLX	3665.....	M100464.....	AP	
35772.....	J000227.....	WLKR	35926.....	X004537.....	WLKR		P270533.....	FIAT	363035AZ.....	P206320.....	DFLX	3666.....	M090544.....	TRUX	
35773.....	J000228.....	WLKR	35927.....	X004476.....	WLKR	3612138.....	P270539.....	FIAT	363040.....	P206321.....	DFLX		M090544.....	AP	
35774.....	J000230.....	WLKR	35930.....	X004538.....	WLKR	3612145.....	P270543.....	FIAT	363040AZ.....	P206321.....	DFLX		M090544.....	GOE	
35775.....	J000232.....	WLKR	35931.....	P270837.....	WLKR		P270543.....	CASE	36319.....	H001284.....	CRMY	3666Q.....	M090544.....	AP	
						3612151.....	M070068.....	CASE	3632.....	M090280.....	AP				

Cross Reference

(See first page of this section for Manufacturer's Code Listing)



CROSS REFERENCE

Mfgs. No.	Our No.	Mfg. Code	Mfgs. No.	Our No.	Mfg. Code	Mfgs. No.	Our No.	Mfg. Code	Mfgs. No.	Our No.	Mfg. Code	Mfgs. No.	Our No.	Mfg. Code
40008	P226129	WLKR	4024S	J024850	ACFT	4071524	X004484	LETO	41013	P206306	WLKR	41472	P206344	WLKR
40009	M045237	SLAR	402545	P206286	XAIR	4073731	H001034	LETO	4101398	P207363	HDMC	41473	P206346	WLKR
	P226129	WLKR	40256	J092679	WLKR	4073737	M100464	MJPR	4102049	M190002	LETO	41474	P207364	WLKR
40010	P226154	WLKR	40257	J092689	WLKR		M100464	MARA		M190002	MARA	41475	P207353	WLKR
40011	P226155	WLKR	402592003	X004478	FMNT	407573001	M060055	FMNT	410354	M120235	SLAR	414755	X004478	WLDN
40012	P226157	WLKR	402592004	X004480	FMNT		M060055	DCOA	4103898	M100463	MARA		X004478	MOB
4001225	M060055	ARRO	402595001	X004536	FMNT	408	P207369	HDMI	41058	P206306	WLKR	41476	P207354	WLKR
4001319500	M120418	CMI	402595002	X004476	FMNT	4080072	M120365	VME	410650	M065065	CRMY	41477	J190025	WLKR
4001905	M060037	ARRO	402595005	X004482	FMNT	40801	M090009	DACR	4108511A	M085078	ALMN	41479	P205979	WLKR
40020	P226132	WLKR	402595006	X004484	FMNT	4081853	P207359	LETO	41094	P206308	WLKR	41480	P205976	WLKR
40021	P226133	WLKR	402595007	X004539	FMNT	4081866	X004539	LETO	41095	P206309	WLKR	41514	P207394	WLKR
40022	P226156	WLKR	402744	M101169	OXBOI	4082047	X004478	CBM	41096	P206310	WLKR	41515	J009650	WLKR
40023	P226158	WLKR		M101169	OXBO	4085865	M080024	MARA	41097	P206311	WLKR	41532	P207339	WLKR
40024	P226154	WLKR	40282	M070028	SLAR		M080024	LETO	41099	P216172	WLKR	41534	P206341	WLKR
40025	P226155	WLKR	402966	H001284	OXBOI	4088683	M120225	VME	41154	J008671	WLKR	41535	P206341	WLKR
40026	P226157	WLKR		H001284	OXBO	409186012	P206526	FMNT	41189	P206279	WLKR	41536	P207362	WLKR
4002735000	H001034	CMI	403001S	J009612	DFLX	409300	P271507	XAIR	41204	P206395	WLKR	41537	P207363	WLKR
4002746000	P207667	CMI	40300G	P226155	ACFT	409350	P271508	XAIR	41205	P206617	WLKR	41538	P207365	WLKR
4002768000	M120131	CMI	40300S	P206604	DFLX	409400	P270837	XAIR	412052AA	P206311	SKYJ	41539	P206299	WLKR
4002827000	M100463	CMI		P226156	ACFT	4094239160	P206607	CMI	412053AA	P206326	SKYJ	41540	P206300	WLKR
4002833000	P270535	CMI	4030S	J024836	ACFT	409500	P270838	XAIR	41217	P206396	WLKR	41557	P207408	WLKR
4002935000	M065044	CMI	403100001	M060158	HERC	409812	H001279	SLAR	41221	P206397	WLKR	41558	P207333	WLKR
4002958000	P270538	CMI	403100953	X004478	HERC	409828C1	M090544	NAVI	41222	P206398	WLKR	41560	P207366	WLKR
4002975000	M090301	CMI	403503S	P222017	DFLX	40AA	J000202	ACFT	41223	P206399	WLKR	41563	P206321	WLKR
400298000	M085090	CMI	403505	P206605	DFLX	40CN104	P206369	PACC	41224	P206400	WLKR	41582	P207339	WLKR
4002980000	M085090	CMI	40350S	P206605	DFLX	40CN104A5A	P206328	ACFT	41233	P206927	WLKR	41583	P207361	HDMI
4003	M090009	KSHA	40364	P206298	WLKR	40CN304	P206374	PACC	4124051	M100463	LETO		P207361	WLKR
4003012000	M122300	CMI	404002S	P222018	DFLX	40CS224A	J024748	ACFT	41249026	X007831	DAEW	41583Q	P207361	HDMI
4003031000	M085023	CMI	404005	P206606	DFLX	40CS224C	J024749	ACFT	41251	P206344	WLKR		P207361	WLKR
4003036000	M100213	CMI	40400S	P206606	DFLX	40CS236A	P208358	ACFT	41252	P206342	WLKR	416001355910	P206600	IRKA
4003064000	M120225	CMI	4041463	X004539	ECLD	40CS236C	P208359	ACFT	41256	P207364	WLKR	416001401902	X004484	NABI
4003064111	M120225	CMI		X004539	VLVO	40CS248A	P206382	ACFT	413001S	J009612	DFLX		X004484	IRKA
400A1014	P206336	TRUX		X004539	VME	40CS248C	P206386	ACFT	41300S	P206604	DFLX	416001401907	P206603	IRKA
	P206336	AP	4043701	X004482	ECLD	40CS260A	P208388	ACFT	413162	M085056	CMI		P206603	NABI
400A1016	P206336	AP		X004482	VME		P208338	PACC	413174	M085207	CMI	416001401925	P206375	IRKA
	P206336	TRUX	404380001	J190055	VMER	40CS260C	P208389	ACFT	413195	M120418	CMI	416001530914	P206337	IRKA
400A1414	P206336	AP	40438001	J190055	VMER	40EL45104A	J190023	ACFT	413196	P208374	CMI	416021401905	M120108	NABI
	P206336	TRUX	4044382	M085410	TYLR	40EL45203A	P207353	ACFT	413216	P206328	CMI		M120108	IRKA
400C1016	P206336	TRUX	40447	P206409	HAWK	40EL90116A	P206344	ACFT	413224	M085090	CMI	416021401909	P206410	IRKA
	P206336	AP	40448	P206388	XAIR	40EL90117A	P206345	ACFT	413225	M090301	CMI	416061530906	P206602	NABI
400S1016	P224686	TRUX	4044942	P207566	TYLR	40EL90117C	P206353	ACFT	413253	X007785	CMI	41612	P207354	WLKR
40100G	P226142	ACFT	404508R1	M070068	CASE	40EL90217A	P207329	ACFT		X007785	CMCO	41614	J009635	WLKR
40100S	P226146	ACFT		M070068	FURU	40EL90219A	P206346	ACFT	413287	M170101	CMI	41615	J009636	WLKR
401116	X007829	SKYJ		M070068	DRSS	40EL90242A	P207364	ACFT	413309	P206304	CMI	41616	J009637	WLKR
401117	X007830	SKYJ		M070068	NAVI	40EL90243A	P206399	ACFT	413311	M090594	CMI	41618	J009631	WLKR
401132	X007784	SKYJ	404595003	X004478	FMNT	40EST	J000216	ACFT	41338S	J009611	DFLX	41619	J009632	WLKR
4011460	P207299	XAIR	40460	P206390	XAIR	40FBC	P206610	ACFT	41365	P206340	WLKR	41620	J018110	WLKR
4011548	P207317	XAIR	4047421	X004484	VLVO	40FBZ	P206602	ACFT	41366	P206342	WLKR	41623	J009644	WLKR
4011560	P207300	XAIR		X004484	ECLD	40GZ	P206410	ACFT	41367	P206344	WLKR	41624	J009645	WLKR
4012448	P207320	XAIR		X004484	VME	40HD	J000230	ACFT	413678A1	M001865	CASE	41626	J009639	WLKR
4012518	P207309	XAIR	404812100	M120108	LETO	40PLA	J009606	ACFT		M001865	CASE	41627	J009640	WLKR
4012548	P207321	XAIR		M120108	MARA	40PLS	J009623	ACFT	41378	P206344	WLKR	41628	J009641	WLKR
4012560	P207302	XAIR		M080018	LETO	40RCC	P270837	ACFT	41400S	J009614	DFLX	41629	P207331	WLKR
4012596	P209912	XAIR	405	P206849	HDMI	40RCZ	P270539	ACFT	4141106	X004482	LETO	41630	J008681	WLKR
4012S	J240006	ACFT	4050	M100465	PHOE	40STA120	P206336	ACFT	41428	P207351	WLKR	41631	P207322	WLKR
401400	P207345	XAIR		M100580	INDIP	40TA	P206297	ACFT	41429	P207352	WLKR	41633	P206342	WLKR
401512	P207346	XAIR		M100465	INDIP	40TS118A	P207297	ACFT	41430	P207353	WLKR	41634	J008681	WLKR
401518	P206354	XAIR	40500	M100580	INDIP	40TS118C	P207308	ACFT	41431	P207354	WLKR	41635	P206344	WLKR
401666	M045237	FMC	40500S	P206607	DFLX	40TS124A	J024746	ACFT	41432	P207324	WLKR	41636	P207362	WLKR
401716	M080018	SKYJ	405094	M1170101	SLAR	40TS218A	P208386	ACFT	41433	P207325	WLKR	41638	P206346	WLKR
4017418	P206384	XAIR	405097	M090535	SLAR	40TS218C	P206384	ACFT	41434	P207326	WLKR	41641	P207351	WLKR
4017436	P208359	XAIR	4050UMB	P207784	ACFT	40X30R104A	P206321	ACFT	41435	P207327	WLKR	41645	P206612	WLKR
4017448	P206386	XAIR	4054049	X004480	VME	40X30R304A	P206315	ACFT	41436	P207332	WLKR	41646	P207619	WLKR
4017518	P206385	XAIR	40548	P206389	XAIR	40X35R104A	P206322	ACFT	41437	P206279	WLKR	41647	P207581	WLKR
4017536	P208375	XAIR	4055	P207368	HDMI	40X35R305A	P206316	ACFT	41438	P207349	WLKR	41648	J009391	WLKR
4017548	P206387	XAIR	40560	P206391	XAIR	40X35R404A	P206327	ACFT	41439	P207350	WLKR	41649	P207568	WLKR
4017560	P208395	XAIR	4058502	X004484	VME	40YTUBE	J092679	ACFT	41440	P207350	WLKR	4165	P206850	INDIP
4018G	J024754	ACFT	406	P206850	HDMI	41001	J008671	WLKR	41441	P207335	WLKR	41650	P207620	WLKR
4018S	P206554	ACFT	406240	P206610	XAIR	41002	P206339	WLKR	41442	P216172	WLKR	41652	P207620	WLKR
402445	P206285	XAIR	406250	P206611	XAIR	41003	P206340	WLKR	41450S	P210110	DFLX	41653	P207567	WLKR
40247	P206297	WLKR	406303	M065074	MOB	41004	P206340	ROSS	414714	M085090	MOB	41654	J009393	WLKR
4024G	J024835	ACFT	4068782	M090146	LETO	41005	P206342	WLKR		M085090	WLDN	41655	P207566	WLKR
			407	P206851	HDMI							41657	P207568	WLKR

(See first page of this section for Manufacturer's Code Listing)

CROSS REFERENCE

Mfgs. No.	Our No.	Mfg. Code	Mfgs. No.	Our No.	Mfg. Code	Mfgs. No.	Our No.	Mfg. Code	Mfgs. No.	Our No.	Mfg. Code	Mfgs. No.	Our No.	Mfg. Code
41658	P207566	WLKR	419838	M080018	WLDN	42069	J024835	WLKR	42350C	P206613	DFLX	42891	P207282	WLKR
41662	J009479	WLKR		M080018	MOB	4207	M101182	AP	42355	J190025	WLKR	4291	P206512	INDIP
41663	P207581	WLKR	41984	P206322	WLKR		M101182	GOE	42356	P206345	WLKR	42910	P206512	INDIP
41685	P207362	WLKR	419843	J009645	RDRL		M101182	TRUX	42377	P206305	WLKR	42936	P207330	WLKR
41687	P207386	WLKR	419844	M120225	RDRL	42070	J024837	WLKR	4239	P206410	INDIP	42937	P206345	WLKR
41691	J240006	WLKR	41985	P206374	WLKR	42071	J024746	WLKR	42400C	P206614	DFLX	42938	P206408	CMI
41692	P224479	WLKR	41986	P206369	WLKR	42072	J024747	WLKR	4241	P207332	INDIP		P206348	WLKR
41693	J240007	WLKR	41987	P206364	WLKR	420801	M090544	PIE	42410	P207332	INDIP	42939	P207331	WLKR
41694	P224481	WLKR	41988	P206326	WLKR	42081	P207332	WLKR		P207332	CAT	42940	P206349	WLKR
4170	M085411	NH	4198828	P207354	LETO	4209	X004484	INDIP	42423	P206554	WLKR	42944	P207341	WLKR
	X004482	INDIP	41989	P206315	WLKR	420920	M080024	FWD	42424	P206555	WLKR	42958	P270538	CMI
4171	P207368	INDIP	41990	P206316	WLKR	420C4361	M100048	KOEh	4243	P2022018	INDIP	429619C1	M090146	NAVI
4173	P206312	INDIP	41991	P206327	WLKR	420V1373	M085023	KOEh	42445	P206341	SLAR	42977	P206342	CMI
41730	P206312	INDIP	41992	P206365	WLKR	420V3912	X004482	KOEh		P206341	WLKR	42978	J028528	WLKR
41751	M060005	SLAR	41993	P206370	WLKR		X004482	TREX	42447	P206304	WLKR	42E4036	P207582	DFLX
41768	P224669	WLKR	41994	P206328	WLKR	420V4349	M120100	KOEh	42448	P206302	WLKR	42F400	P207616	DFLX
41769	J190003	WLKR	41995	P206317	WLKR	420V4351	M085023	KOEh	42449	P206303	WLKR	42P350	J009391	DFLX
418195A1	M001756	CASE	41996	P206375	WLKR	420V4360	M100049	KOEh	424504	P206346	RDRL	42P400	P206614	DFLX
4182268	M090159	FMC	41997	P207402	WLKR	420V4375	M100464	KOEh	42451	P206280	WLKR	42P500	P206615	DFLX
41832	P206400	WLKR	41998	P206318	WLKR	420V4376	M100464	KOEh	42452	P206281	WLKR	42P50045	J009393	DFLX
4185027	M190002	LETO	41999	P206324	WLKR	420V4382	M090170	KOEh	42453	P206283	WLKR	42R0210060YF	P206406	HNMG
41862	P207568	WLKR	41A300466A1	P207667	GE	420V4383	M100043	KOEh	42455	P206553	WLKR	42R300	J009393	DFLX
4186214A	P226148	ALMN	41A300466BP1	P207667	GE		M100043	TREX	424760	P206519	INDIP	42R350	P207581	DFLX
41865	P206605	WLKR		P207667	GEPa	420V4386	M100464	KOEh	424857C1	M090544	NAVI	42R35045	P207568	DFLX
41889	M100048	GEHL	41A300466P1	P206411	GE	420V4387	M090158	KOEh	424858C1	M090544	NAVI	42R400	P207620	DFLX
	P207414	WLKR		P206411	PRTCTR	420V4388	M090535	KOEh	42492	P206552	WLKR	42R40045	P207567	DFLX
41890	J009648	WLKR		P206411	GEPa	420V4390	M090538	KOEh	42500	P207329	WLKR	42R50045	P207566	DFLX
41891	J009649	WLKR	41A300470P1	M120108	AUTM	420V4391	M120235	KOEh	42500C	P206615	DFLX	42T400	P206617	DFLX
41892	P206372	WLKR		M120108	AMTK	420V4393	M120154	KOEh	425137C91	M090074	NAVI	43012	M122300	CMI
41893	P206373	WLKR		M120108	ATHM		M120154	TREX	42515	P206347	XAIR		M122300	POWER
41895	P206374	WLKR		M120108	GE	420V6300	M170101	KOEh	42518	P206348	XAIR	4302	P207362	XAIR
41896	P206369	WLKR	41A300754P1	P207394	GEPa	420V6302	M120131	TREX	42530	J024739	WLKR	43020	P270543	CMI
41897	P206370	WLKR	41A301438P1	P270541	GEPa	420V6308	M100463	KOEh	42531	J024737	WLKR	43030	M090158	RDRL
41898	P206317	WLKR		P270541	GE	42104	M001668	KW	42534	P206308	WLKR	4303076	M120365	TYLR
41899	P206375	WLKR		P270541	ATHM	42125	M001668	PACC	42536	P207415	WLKR	43036	M100213	CMI
41902	P207411	WLKR	41A312661P1	X004484	GE	42126	P207332	WLKR	42543	J024750	WLKR	43064	M120225	CMI
41909	P206323	WLKR		X004484	GEPa	42126	P207283	WLKR	42544	J024748	WLKR	43064111	M120225	CMI
41939003	J240005	DAEW	41B590490P1	M170101	GE	42127	P207281	WLKR	425507C1	M090544	NAVI	4310560	P208393	XAIR
4194	P206411	INDIP		M170101	ATHM	42128	P207559	WLKR	42562	P216175	WLKR	4311460	P207288	XAIR
41940	P207405	WLKR	420039	M090535	PIE	42129	P208386	WLKR	42570007	P270539	AGCA	4311560	P207289	XAIR
41944	P207411	WLKR	420225	M120100	PIE	42130	P208392	WLKR	425937C1	M090074	NAVI	43115U	M060388	NLSN
41947	P207411	WLKR	420256	M120225	PIE	42132	P208338	WLKR	42594	P207419	WLKR	4312448	P207295	XAIR
4194907045	P270536	FRTL	4203267	M070008	KOEh	4214	P206849	INDIP	426428C91	M090538	NAVI	4312460	P207290	XAIR
4194927029	M070068	FRTL	4203914	X004484	KOEh	421436	P270534	CLJL	42715	P207297	WLKR	431256C1	M100464	NAVI
	M070068	MERS		X004484	TREX		P270534	CLRk	42716	P207298	WLKR	431517R91	M090544	NAVI
419499	M065071	WLDN	4204307	M090009	KOEh	42147	P207332	WLKR	427170	M090009	CLRk	43171003	M140048	MJPR
	M065071	MOB	4204310	M120100	KOEh	4215972M91	H001279	HNMG	42728	M090280	CMI	4317560	P208394	XAIR
41957	P206371	WLKR	4204349	M120100	KOEh	4215997	M100508	LETO	42735	H001034	CMI	4317572	P224600	XAIR
41958	P207382	WLKR	4204351	M085023	KOEh	42175	P206544	WLKR	42746	P207667	POWER	431792C1	M100464	NAVI
41959	P207397	WLKR	4204360	M100049	KOEh	42178	P216191	WLKR		P207667	CMI	43202	J034673	WLKR
41960	P207389	WLKR	4204373	M085023	KOEh	4218	M090781	AP	427470	P270530	PIE	43203	J034673	WLKR
4196234	P207341	LETO	4204375	M100464	KOEh	42185	P206343	WLKR	42748	P206350	CMI	4324836	X004478	BLDY
4196273	M120154	ABSP	4204376	M100464	KOEh		P206343	WLKR	42755	H001034	CMI	4324844	X004538	BLDY
41963	J008942	WLKR	4204378	M090538	KOEh	422032	M100049	CRMY	42756	P207667	CMI	4324851	X004478	BLDY
41964	P206361	WLKR	4204388	M090535	KOEh	4223	M060038	TRUX	42758	P206282	WLKR	4324869	X004480	BLDY
41966	P206366	WLKR	4204391	M120235	KOEh	4224488	M120131	LETO	4276	P206519	INDIP	4324877	X004482	BLDY
41968	P206325	WLKR	4204408	M085208	KOEh	42246	J190023	WLKR	42760	P206280	WLKR	4327869	X004480	BLDY
41969	P206372	WLKR	4204754	H001279	KOEh	42247	P207353	WLKR		P206519	INDIP	43319	P208364	WLKR
41970	P206367	WLKR		H001279	TJAK	4225	M110189	TRUX	42761	P206281	WLKR	43320	P208366	WLKR
41971	P206362	WLKR		H001279	HSTR	422509	M100048	PIE	42762	M190002	CMI	43328	M100463	RDRL
41972	P206324	WLKR	4204757	H001284	KOEh	42252	J009560	WLKR	42763	P207339	WLKR	43348	P206347	WLKR
41973	P206313	WLKR	4205	M120450	AP	42253	P207332	WLKR	42768	M120131	CMI	43366	P208348	WLKR
41974	P206319	WLKR		M120450	TRUX	42272	P206347	WLKR	427704	J190004	PIE	43381	J034743	WLKR
41975	P207386	WLKR		M120450	GOE	42288	P207328	WLKR	428193	M100463	PIE	43382	J034744	WLKR
41976	P206367	WLKR	420560	J540008	XAIR	422930C1	M090544	NAVI	4284330	J240006	BAESYS	43405	M090538	SLAR
41977	P206373	WLKR	4206	M101181	AP	42300	P206612	DFLX	42855	P206286	WLKR	4342589	P270536	CLRk
41978	P206368	WLKR		M101181	TRUX	42300C	P206612	DFLX	42856	J009560	WLKR		P270536	CLRk
4197837A	M065044	ALMN		M101181	GOE	42317	P206547	WLKR	42857	P207329	WLKR	4343150	P206410	VLVO
41979	P206363	WLKR	4206022	M120131	KOEh	42320	P208366	WLKR	42858	P206347	WLKR	4343154	X004482	VLVO
41980	P206325	WLKR	4206302	M120131	KOEh	42336	P206282	WLKR	4288	J009487	INDIP	43438	P207340	WLKR
41981	P206314	WLKR	42066302	M120131	KOEh	42338	J024836	WLKR	42880	J009487	INDIP	434836C1	M100464	NAVI
41982	P206320	WLKR	42067	J024754	WLKR	42339	J024838	WLKR	4289	P206385	INDIP	434847C1	M090535	NAVI
41983	P206368	WLKR	42068	J024755	WLKR	42344	J190013	WLKR						

Cross Reference

(See first page of this section for Manufacturer's Code Listing)



CROSS REFERENCE

Mfgs. No.	Our No.	Mfg. Code	Mfgs. No.	Our No.	Mfg. Code	Mfgs. No.	Our No.	Mfg. Code	Mfgs. No.	Our No.	Mfg. Code	Mfgs. No.	Our No.	Mfg. Code
4352	P207363	XAIR	44665	P206382	AP	4571000106	M090158	IAMG	46653365	M120131	RSNB	47D6400	P206410	DFLX
43582	P208380	WLKR		P206382	TRUX		M090158	CEDAR	46664250	M060005	RSNB	47D6500	P206411	DFLX
43601	P206343	WLKR	44666	P207296	TRUX		M090158	CRPD	46665250	M070008	RSNB	47D6600	P207667	DFLX
43602	P206345	WLKR		P207296	AP	4571000112	M065065	CEDAR	46665770	M120154	RSNB	47D6700	P206403	DFLX
436021401902	X004482	IRKA	44667	P206383	AP		M065065	CRPD	46665796	M090535	RSNB	47G225	P206404	DFLX
43606	P208324	WLKR		P206383	TRUX	4571000114	M065044	CEDAR	46665797	M090009	RSNB	47G250	P206405	DFLX
436198C1	M090146	NAVI	44668	P207320	AP	4571000117	M085206	CRPD	46665797M	M090009	RSNB	47G300	P206407	DFLX
4362138	P206614	VLVO	44669	P206386	AP		M085206	CEDAR	46665799	M090072	RSNB	47G350	P206409	DFLX
4362139	P270541	VLVO	44670	P207321	AP	4571000207	P207667	CEDAR	466817C1	M090170	NAVI	47G400	P206410	DFLX
43668	P207359	WLKR	44671	P206387	AP	4571000321	M06345	CEDAR	466984C1	M085023	NAVI	47G400CP	J009486	DFLX
43698	P207329	WLKR	44682	P206377	AP	457100114	M065044	CRPD	466984C91	M085023	NAVI	47G500	P206411	DFLX
43699	P207331	WLKR	44684	P206381	AP	45726	P208388	WLKR	467364C1	M100464	NAVI	47G500CP	J009487	DFLX
43718	P208358	WLKR	447124C1	M090146	NAVI	45727	P208394	WLKR	467614C1	M090170	NAVI	47G600	P207667	DFLX
43719	P208374	WLKR	447125C1	M090146	NAVI	45795531	M001702	VLVO	46778	P207289	WLKR	480489C1	M090170	CASE
437790C1	M090538	NAVI	44725	P207314	AP		M001702	IR	469801C1	M090535	NAVI	M090170	NAVI	
43800135	P222755	IR	44728	P206376	AP	459M	M100466	VCOR	46A1020	M085056	FMC	4812727C2	M090547	NAVI
43846716	M065141	IR	44728Q	P206376	AP		M090781	VCOR		M085056	LKBT	481445C2	M090548	NAVI
	M065073	IR	44730	P207285	AP	45A0154X	M090158	FMC	46G300	P206600	DFLX	481727C2	M090547	NAVI
43846880	M001756	IR		P207285	GOE	45A1238	M100146	FMC	46G350	P206601	DFLX	482167C1	M090520	NAVI
	M002118	IR	44731	P207286	TRUX		M100146	LKBT	46G400	P206602	DFLX	482739C91	X004476	NAVI
43849355	M001756	IR		P207286	AP	45EST	J000219	ACFT	46G500	P206603	DFLX	482894C1	M120365	NAVI
	M002118	IR	44732	P207293	AP	45PLS	J190062	ACFT	46G600	P207596	DFLX	48450275	H001284	FMCO
43876716	M065141	IR	44734	P207318	AP	45R40	P270543	CASE	46U303	M065074	MOB		H001284	CASE
43897180	P207596	IR	44735	P207319	AP	460303	M065074	MOB		M065074	WLDN		H001284	NH
43904515	P222744	IR	44736	P206380	AP		M065074	WLDN	4700921989	M045237	DYPC		H001284	FIAT
	P222744	VLVO	44737	P207312	AP	4603865H1	M090544	DRSS	470263M91	M070068	MF	48450419	H001279	FIAT
43919646	M090210	IR	447662C1	M100052	NAVI		M090544	KTSU	470836C91	X004538	NAVI		H001279	FMCO
439248R91	M100049	NAVI	44786	P226142	AP	460568	J024757	WLDN	470837C91	X004478	NAVI		H001279	NH
43927623	P206325	IR		P226142	TRUX		J024757	MOB	470838C91	X004480	NAVI		H001279	CASE
439797C1	M100052	NAVI	44853	P206381	AP	460742000	P270540	TRJN	470839C91	X004482	NAVI	48488SC1	M090538	NAVI
43B25	M045237	GRDL		P206381	TRUX	460C119	P206850	CASE	4710519	M065074	MILR	485123C91	X004478	NAVI
440377C1	M100052	NAVI	44854	P207285	TRUX	460C129	P207367	SIGM	47129001005720	M100572	SUSN	485124C91	J009604	NAVI
44045	M085090	PETTI	44863	P216197	TRUX		P207367	CASE	47129002063260	P206326	SUSN	485934C1	M100465	NAVI
440737C1	M085023	NAVI	44GH96	P207667	GTMN	460V6301	M100146	KOEK	47129002066000	P206600	SUSN	486089C1	M100463	NAVI
44126	P207287	WLKR	44J000233	J000233	PPOW	461091900	P270538	TRJN	47129002066020	P206602	SUSN	486109R91	M100465	NAVI
44127	P207292	WLKR	44M001505	M001505	PPOW	462513C91	M090544	NAVI	471382C1	M085023	NAVI	486110C1	M100465	NAVI
44280	P206311	WLKR	44M122300	M122300	PPOW	46300	P206608	DFLX	47150	P222748	DFLX	486118C1	M100465	NAVI
442926C1	M100464	NAVI	450275	H001284	CASE	46300CP	P206608	DFLX	47200	P206403	DFLX	48756	P270536	CRMY
442928C1	M090535	NAVI		H001284	FIAT	46300Z	P206600	DFLX	47225	P206404	DFLX	488710C2	M085189	NAVI
442930C1	M090544	NAVI	450288030	X004478	PCFE	463026C1	M090544	NAVI	4724170	P206542	GRVE	489737C91	X004476	NAVI
442937C1	M100464	NAVI	450362	H001278	FIAT	46346	P206410	HAWK	47250	P206405	DFLX	489790C91	X004537	NAVI
44299	P207295	WLKR		H001278	CASE	46350	P206609	DFLX	47275	P206406	DFLX	48992	P206317	VACT
44300	P207296	WLKR		H001278	NH	46350CP	P206609	DFLX	47300	J000227	DFLX	48B5120	P206369	AA
44301	P207285	WLKR		H001278	FMCO	46350Z	P206601	DFLX	47350	J000228	DFLX	48B5121	P207364	AA
44302	P206380	WLKR		H001278	FMCO	463541C1	M065065	NAVI	47400	J000230	DFLX	48B5122	P206326	AA
444229C1	M100052	NAVI	450419	H001279	CASE	463765C1	M090170	CUCG	474403	P208330	MOB	48B5123	M100048	AA
44456	P206378	WLKR		H001279	FMCO	46400	P206610	DFLX	47450	J000231	DFLX	48C300	P206523	DFLX
44457	P206379	WLKR		H001279	NH	46400CP	P206610	DFLX	47500	J000232	DFLX	48C350	P206524	DFLX
4450	M070028	CRMY		H001279	FIAT	46400Z	P206602	DFLX	475354C1	M100463	NAVI	48C400	P206525	DFLX
4452	P206409	CRMY	45066	P207288	WLKR	46445800	P270539	DRBG	47600	J000233	DFLX	48C500	P206526	DFLX
445545L	J038611	XAIR	4507036R	M100016	DRSS	464643C1	M085023	NAVI	476349C91	J009606	NAVI	48C600	P206515	DFLX
445545R	J038612	XAIR		M100016	NAVI	46483200	P270540	DRBG	477663	M045193	MOB	48CH300	P206523	DFLX
44569	P206350	WLKR		M100016	FURU	46484400	H001035	DRBG	47786B	M090544	OKSH	48CH350	P206524	DFLX
44630	M070069	SLAR	4507036R1	M100016	CUCG	46484500	M001504	DRBG	47786BX	M090544	OKSH	48CH400	P206525	DFLX
44634	P206381	WLKR	45074	M070068	KSHA	46485200	P208392	DRBG	4784	J000227	NH	48CH500	P206526	DFLX
44637	P206382	WLKR	4509	P207365	XAIR	46485300	P206411	DRBG	479002	P270532	AA	48G200	J009633	DFLX
44638	P206383	WLKR	45110SS	J009429	HDMI	46486400	P270541	DRBG	47972	P206331	WLKR	48RU2341	J009614	MACK
44653	P206379	WLKR	451232	P270541	MOXY	46500	P206611	DFLX	47976	P206331	WLKR	49006	P206331	WLKR
44654	P206378	WLKR	45185SS	P206540	HDMI	46500CP	P206611	DFLX	47978	P206333	WLKR	49008	P206333	WLKR
44656	P207287	TRUX	45190SS	J009429	HDMI	46500Z	P206603	DFLX	47984	P206331	WLKR	49009	J000127	WLKR
	P207287	AP	4523	P206380	NH	465971C1	M085023	NAVI	47987	P206333	WLKR	49010	P206334	WLKR
44657	P206378	AP	45233	P207290	WLKR	46600	P207598	DFLX	47988	P206331	WLKR	49011	P206335	WLKR
	P206378	TRUX	45247	P224710	WLKR	46600CP	P207598	DFLX	47989	P206331	WLKR	49012	P206336	WLKR
44658	P207292	AP	452508A1	J190061	MCC	46600Z	P207596	DFLX	47993	P206331	WLKR	4901271	M090544	WSTI
	P207292	TRUX	453142C1	M001327	NAVI	46634150	M065073	IR	47996	P206333	WLKR		M090544	VLVO
446583	M100048	FMCO	453180C1	M090072	NAVI	46651026	M100463	RSNB	47A0978	M090301	FMC	49014272	M100464	VLVO
44659	P206379	AP	45340	P208393	WLKR	46651029	M120108	RSNB		M090301	LKBT	49015280	M100464	WSTI
44661	P206388	AP	454305C91	M100464	NAVI	46651044	M120131	RSNB	47A978	M090301	FMC	M100464	WSTI	
44662	P207317	AP	454306R91	M090544	NAVI	46651050	M100463	RSNB	47DG200	P206403	DFLX	M100464	WSTI	
44663	P206389	AP	45430891	M090535	NAVI	46652000	M090544	RSNB	47DG250	P206405	DFLX	49016	P206331	WLKR
44664	P207295	TRUX	454308R91	M100464	NAVI	46653350	M120100	TREX	47DG300	P206407	DFLX	49024	P206331	WLKR
	P207295	AP	45564	M070008	SLAR		M120100	RSNB	47DG350	P206409	DFLX	49026	P206333	WLKR
												49027	P206338	WLKR
												49028	P226140	WLKR

(See first page of this section for Manufacturer's Code Listing)

Mfgs. No.	Our No.	Mfg. Code	Mfgs. No.	Our No.	Mfg. Code	Mfgs. No.	Our No.	Mfg. Code	Mfgs. No.	Our No.	Mfg. Code	Mfgs. No.	Our No.	Mfg. Code
49029	P226141	WLKR	49786	X004537	SLAR	501251	P270539	TMRK	504959C91	J009604	NAVI	50EL90120C	P207346	ACFT
49030	P226142	WLKR	49787	X004476	SLAR	501252	P206602	TMRK	504960C91	J009605	NAVI	50EL90121A	P206348	ACFT
49031	P226143	WLKR	499373	P207326	CMWK	501254	P206315	TMRK	505110	M060483	PDEL	50EL90122A	J190003	ACFT
49032	P226144	WLKR	499495C1	M100464	NAVI	501258	M001702	TMRK	505491	M090520	VOEG	50EL90122C	J190004	ACFT
49032190	M120176	WGMC	499528C1	M085023	NAVI	501259	M001503	TMRK		M090520	GASP	50EL90123A	P207339	ACFT
49033	P226145	WLKR	4E13463	M070008	SHBR	5012654	X004482	NABI	505533	X006203	VOEG	50EL90123C	J009547	ACFT
49033350	M090535	VLVO	4H0243	P206344	LKBT	5012S	J240007	ACFT	50579085	M090170	IR	50EL90124C	P206354	ACFT
49034	P226146	WLKR	4ME21698	J028528	MACK	5013708	X006203	IRKA	505881	M100048	DRDT	50EL90220A	J190019	ACFT
49034037	M120131	WGMC	4P5575	P207667	CAT		X006203	NABI	505897	P216197	GASP	50EL90224A	P206349	ACFT
	M120131	WSTI	4PS4174	M120100	CHLN	5014439	M120189	NABI		P216197	VOEG	50EL90243A	P207365	ACFT
49034554	M090535	VLVO	4W5119	P206409	CAT	501462C1	M090535	NAVI	505898	P207419	GASP	50EL90244A	P207332	ACFT
49035	P226147	WLKR	5			501463C1	M100463	NAVI		P207419	VOEG	50EST	J002117	ACFT
49036	P226150	WLKR	500001	P270532	DMT	501464C1	M100465	NAVI	505899	P207596	GASP	50FBC	P206611	ACFT
49037185	M100464	WSTI	500002	P270533	DMT	501471C91	J009606	NAVI		P207596	VOEG	50FBZ	P206603	ACFT
	M100464	WGMC	500003	P270534	DMT	5017090	M070069	SLVN	5066011	X004482	NABI	50GZ	P206411	ACFT
49037199	M090535	VLVO	500004	P270535	DMT	501709012	M100016	SLVN	506960	P207341	GASP	50H0072	X004480	FMC
49037885	M120154	WSTI	500005	P270536	DMT		M100016	PALA		P207341	VOEG		X004480	LKBT
	M120154	VLVO	500008	P270539	DMT	50170907	M070069	PALA	507036R1	M100016	CUCC	50HD	J000232	ACFT
49039302	M090072	WGMC	500009	P270540	DMT	50170909	M065030	SLVN	507064	M070008	CLRK	50MP3401	P206338	AA
49039303	M100463	VLVO	50000971	P207394	CUMS	50174500010	P270534	SLVN	507101	M060158	PDEL	50MS236C	P216227	ACFT
	M100463	WSTI	500010	P270541	DMT	501745010	P270534	SLVN		M060158	OTWA	50MS248C	P216228	ACFT
	M100463	WGMC	50001076	P206313	CUMS	50175250002	X004539	SLVN		M060158	TDYN	50MS260C	J540008	ACFT
49039309	M100465	VLVO	50001078	P206372	CUMS	50175550004	X004484	SLVN	507120	M060251	OTWA	50PLA	J009607	ACFT
49041	P226334	WLKR	500011	P270542	DMT	50175700003	X004482	SLVN	507122	M045193	PDEL	50PLS	J009624	ACFT
49042	P226148	WLKR	500012	P270543	DMT	501803	M090170	CLRK	507218	M045193	PDEL	50RCC	P270838	ACFT
49043	P206331	WLKR	50001253	P206370	CUMS	50187850011	M120365	SLVN		M045193	TDYN	50RCZ	P270541	ACFT
49043656	M090535	VLVO	50001561	M090158	KOEH		M120365	JOY	508223	X004962	VOEG	50S248C	P206389	ACFT
49044	P226152	WLKR	50001561	M065065	KOEH	50187850015	M065044	JOY	508420	M090158	DRDT	50S260C	P206391	ACFT
49044073	M100465	WSTI	5000485443	X004482	RVI		M065044	SLVN	508699	M090170	DRDT	50STA120	P206337	ACFT
	M100465	WGMC	5000600824	X004962	RVI	50187850019	M120176	PALA	508705	M085023	WGMC	50TA	P206298	ACFT
49044082	M080024	VLVO	5000692520	P270534	RVI		M120176	SLVN	508708	M085023	WGMC	50TQ300AZ	J009604	DFLX
	M080024	WSTI	5000692526	P270538	RVI	50187850023	M100049	SLVN	50871714	M070028	IR	50TQ350AZ	J009605	DFLX
49044343	M100463	WSTI	5000785443	X004482	RVI	50187850028	M085208	SLVN	508793C91	X007829	NAVI	50TQ400AZ	J009606	DFLX
	M100463	VLVO	5000785443	X004482	RVI	501878507	M100048	SLVN	508795C91	X007830	NAVI	50TQ500AZ	J009607	DFLX
49045022	M100465	WSTI	500104908	X004476	JOY	501878515	M065044	SLVN	508796	P207324	MOB	50TS118A	P207298	ACFT
	M100465	VLVO	500308732	P206405	IVECO	501878523	M100049	SLVN		P207324	WLDN	50TS118C	P207309	ACFT
49047	P226140	WLKR	500353	P206403	DMT	501878527	M100048	SLVN	508796C91	X007831	NAVI	50TS200	X004536	DFLX
49049	P206333	WLKR	500354	P206404	DMT	501878528	M085208	SLVN	508797C91	X007784	NAVI	50TS218A	P208392	ACFT
49050	J000127	WLKR	500355	P206405	DMT		M085208	PALA	508798C91	X007785	NAVI	50TS218C	P206385	ACFT
49051	P206334	WLKR	500356	P206406	DMT	501878529	M090595	SLVN	508804C1	M090548	NAVI	50TS225	X004537	DFLX
49052	P206336	WLKR	500357	P206407	DMT	501878533	M085207	PALA	508887C91	X004482	NAVI	50TS250	X004476	DFLX
49056	P206337	WLKR	500358	P206408	DMT	501878535	M080018	PALA	508903C91	X004480	NAVI	50TS275	X004538	DFLX
49060	P226151	WLKR	500359	P206409	DMT	5018935	X004482	GRDR	50901719	M085090	IR	50TS300	X004478	DFLX
49062	P206338	WLKR	500360	P206410	DMT		X004482	GRDL	5092237	X007831	VLVO	50TS350	X004480	DFLX
49063	P226153	WLKR	500361	P206411	DMT	5018G	J024755	ACFT	50AA	J000203	ACFT	50TS400	X004482	DFLX
49064	P206337	WLKR	500362	P207667	DMT	5018S	P206555	ACFT	50CN305A	P206375	ACFT	50TS400AZ	X006203	DFLX
49065	P206334	WLKR	5006011	X004482	NABI	50191021	M070028	SLVN	50CS118C	P207309	ACFT	50TS450	X004962	DFLX
49066	P206334	WLKR	5008421	M120131	NABI	502393	P206309	IR	50CS124C	J024758	ACFT	50TS500	X004484	DFLX
49077	P226148	WLKR	500872C1	M100463	NAVI		P206309	GASP	50CS136C	P216204	ACFT	50TS600	X004539	DFLX
49091	P226141	WLKR	500873C91	M100463	NAVI	502492	P206309	VOEG	50CS148A	P207296	ACFT	50X40R105A	P206323	ACFT
49092	P226148	WLKR	5009617	P206407	ELGN		M085056	IR	50CS148C	P207321	PACC	50X40R306A	P206317	ACFT
4910020	P226151	ELGN	5009619	J014623	IRKA		M085056	VOEG		P207321	ACFT	50X40R405A	P206328	ACFT
4910021	P226152	ELGN	500A1016	P206337	TRUX		M085056	CRMY	50CS160C	P207302	ACFT	50YTUBE	J092689	ACFT
49110U	M045123	NLSN		P206337	AP	502494	P206362	IR	50CS172C	P216205	ACFT	5100006	P206334	TIPP
49120A	M060037	NLSN	500S1016	P224687	TRUX		P206362	CRMY	50CS196C	P209910	ACFT	51008	P207667	WILM
49120B	M060037	NLSN	501004	M060158	TMCO	5024G	J024837	ACFT	50CS218A	P208392	ACFT	510112	P222748	ARV
49125A	M065030	NLSN		M060158	TYMC	5024S	J024838	ACFT	50CS218C	P206385	ACFT	5102	M090544	TBCR
49130A	M070068	NLSN	5010051666	P270543	RVI	502527	P270536	IR	50CS224A	J024750	ACFT	510205	X004536	MRMT
49135A	M070069	NLSN	50100G	P226143	ACFT		P270536	CRMY	50CS224C	J024751	ACFT		X004536	MARE
49140A	M080024	NLSN	50100S	P226147	ACFT	50266964	M085056	IR	50CS236A	P208374	ACFT	510205CQ	X004536	MARWIL
49146	P206333	WLKR	5010317804	X007784	RVI	50266972	P206407	IR	50CS236C	P208375	ACFT	510230	X004537	MRMT
49150A	M090091	NLSN	50114	P206554	WILM	502852	M080024	TMCO	50CS248A	P206383	ACFT		X004537	MARE
49159	P206334	WLKR	501152	P206400	DMT	502879	P270543	TMRK	50CS248C	P206387	ACFT	510230CQ	X004537	MARWIL
49160A	M100016	NLSN	501153	P206341	DMT	502882	P207667	TMRK	50CS260A	P208394	ACFT	510234	J000224	ARV
49161	P206336	WLKR	501155	P207332	DMT	502997	P208328	IR	50CS260C	P208395	ACFT	510255	X004476	MRMT
49162	P206337	WLKR	501158	P206345	DMT	50300G	P226157	ACFT	50CS272A	P224600	ACFT		X004476	MARE
492894C1	M120365	CUCC	501159	P206395	DMT	50300S	P226158	ACFT	50EL15260A	P206396	ACFT	510255CQ	X004476	MARWIL
494239160	P206607	CMi	501160	P206399	DMT	5030S	J024838	ACFT	50EL45105A	J190025	ACFT	510270	J009612	ARV
49540	M090538	SLAR	501162	P207324	DMT	5030S	J024838	ACFT	50EL45106A	J190027	ACFT	510280	X004538	ARV
49660	X004478	SLAR	501163	P206283	DMT	504808	M100463	TMRK	50EL45205A	P207354	ACFT		X004538	MRMT
496696	M090091	FWD	501164	P206340	DMT	504886C1	M100465	NAVI	50EL67250A	J009560	ACFT		X004538	MARE
49688	M060005	KTSU	501170	M100043	TMRK	504926C1	M090563	NAVI	50EL90120A	P206347	PACC	510280CQ	X004538	MARWIL
	M060005	DRSS				504943C1	M090535	NAVI		P206347	PACC	510295	J009611	ARV

Cross Reference

(See first page of this section for Manufacturer's Code Listing)



CROSS REFERENCE

Mfgs. No.	Our No.	Mfg. Code	Mfgs. No.	Our No.	Mfg. Code	Mfgs. No.	Our No.	Mfg. Code	Mfgs. No.	Our No.	Mfg. Code	Mfgs. No.	Our No.	Mfg. Code	
510300.....	J00227.....	ARV	5179058.....	M090009.....	GM	52154440.....	X004484.....	IR	5326522011.....	P213191.....	GILB			M120108.....	MTWC
510305.....	X004478...MRMT			M090009....	ALSN	52154457.....	X004539.....	IR	53300.....	P226144.....	DFLX	5369600.....		M100043.....	MNTW
	X004478...MARE		5179206.....	M070008....	ALSN	52154465.....	X004962.....	IR	5330012.....	J240003.....	DFLX	536961.....		M090158.....	MNTW
510305CQ.....	X004478MARWIL			M070008....	GM	52167400.....	X004478.....	IR	5330018.....	P206552.....	DFLX	5369610.....		M090158.....	MNTW
510312.....	J000228.....	ARV	518101.....	P206515.....	TDYN	52188.....	P207353.....	WIRG	5330024.....	J240004.....	DFLX	5369670.....		M120748...GRVE	
510355.....	X006204...MRMT		518110.....	M060483....	PDEL	52189.....	P270539.....	WIRG	5331000013.....	M100146....	TREX			M120748.....	MNTW
	X006204...MARE		5181515.....	M060005....	GM	5219802.....	M065034....	CASE	533205M1.....	M060037....	AGCO	536968.....		M190002.....	MNTW
510355CQ.....	X006204...MARE		519020014.....	M170101....	JOY	5220817.....	M085023....	CASE		M060037.....	MF	5369680.....		M190043.....	MNTW
	X006204MARWIL		519020018.....	M045237....	SLVN	5222578.....	M120154....	CASE	53333.....	M070008....	KTSU	536969.....		M100463.....	MNTW
510370.....	P206605.....	ARV		M045237.....	JOY	52266152.....	M170101.....	IR	53350.....	P226145.....	DFLX	5369690.....		M100463.....	MNTW
5103700.....	M100146....	GRDL	519058.....	M120131....	WGMC	522726.....	P206409.....	AGEM	5335012.....	J240005.....	DFLX	536975.....		M120235.....	MNTW
510400.....	J000230.....	ARV	5191020001.....	M070028....	SLVN	522729.....	M001503....	AGEM	5335018.....	P206552.....	DFLX	5369750.....		M120235...MTWC	
510405.....	X006203...MARE		5191021.....	M070008....	JOY	52284072.....	P207332.....	IR	5335024.....	J024850.....	DFLX			M120235.....	MNTW
	X006203...MRMT		51910213.....	M065065....	JOY	523254616.....	M085023....	CANF	53350600.....	M002118....	PALA			M120235....	GRVE
510405CQ.....	X006203MARWIL		51910214.....	M170101....	JOY	523269968.....	M100463....	CANF	533938.....	M090544....	FWD	5369770.....		M100048.....	MNTW
510505.....	X006202...MRMT		51910218.....	M045237....	JOY	523273707.....	M100146....	CANF	53400.....	P226156.....	DFLX	5369790.....		M190043.....	MTWC
	X006202...MARE		5191025.....	P206406....	SLVN	523665.....	M060037....	STIL	5340012.....	J240006.....	DFLX			M100463.....	MNTW
510505CQ.....	X006202MARWIL		5192730004.....	M070068....	SLVN	523719C1.....	M100464....	NAVI	5340018.....	P206554.....	DFLX	5369860.....		P206512....	MNTW
5107090.....	M070069.....	JOY	5192734.....	M070068....	SLVN	524258.....	M001566....	AGEM	5340024.....	J024836.....	DFLX	5369880.....		M090544.....	MNTW
51087850011.....	M120365....	SLVN	5194700003.....	P206407....	SLVN	525.....	M085189....	GRMC	5340036.....	J034673.....	DFLX	537145D1.....		P224617....	AGEM
510998.....	M001502....	TMRK	5194700004.....	P206410....	SLVN	52500389.....	M090301....	BAKO	534948.....	M090146....	TMTR	53753.....		H001034....	CRMY
510CP.....	P206512.....	HDMI	5194700012.....	P206411....	SLVN	527121D1.....	J240007....	AGEM	53500.....	P226158.....	DFLX	537890.....		M120108....	WGMC
5110.....	M085171....	TBCR	5194700014.....	P206409....	SLVN	527122D1.....	P224481....	AGEM	5350012.....	J240007....	DFLX	53793.....		P206304....	CRMY
511196.....	M065034....	AGEM	51947012.....	P206411....	SLVN	527123D1.....	P206555....	AGCO	53500139.....	M085056....	BAKO	538454.....		P270534....	XMIN
5112.....	M100465....	TBCR	51947014.....	P206409....	SLVN		P206555....	AGEM	53500179.....	M090170....	ROSS			P270534....	AMC
51200.....	P226148....	DFLX	5194705.....	P206406....	SLVN	527124D1.....	J024755....	AGEM		M090170....	BAKO	5384540.....		P270534....	CLJL
5122291.....	M100465....	BLDY	519514.....	P207362....	AGEM	527224.....	M090158....	SLAR	5350018.....	P206555....	DFLX	538885.....		X004480.....	CAT
512293C1.....	M065065....	NAVI	5195718.....	P206334....	FMC	527766.....	X004484....	MOGU	53500192.....	M070008....	BAKO			X004480.....	MBSI
51250.....	P226149....	DFLX	5198459.....	P207362....	FMC	528905.....	M090544....	BRWY	5350024.....	J024838....	DFLX			X004480.....	TIM
512736.....	M120100....	BRWY	51986.....	M060005....	KTSU	52892.....	M100463....	URIG	53500308.....	P206410....	BAKO	539583.....		M120100....	WGMC
5128503.....	H001279....	FIAT		M060005....	DRSS	5292627.....	M090170....	CLRK	5350036.....	J034674....	DFLX	539585.....		M120100....	WGMC
	H001279....	NH	5198667.....	P207364....	FMC	5294858.....	X004476....	ECLD	53500370.....	P206346....	DFLX	540008.....		J540008....	AP
	H001279....	HTHI	5198679.....	P206606....	FMC		X004476....	CLRK	53500374.....	M100146....	BAKO	540012.....		M085080....	MOCH
	H001279....	CASE	519875.....	P206606....	FMC		X004476....	CLJL	53500389.....	M090301....	BAKO			M085080....	PRVT
51299832.....	M100146....	IR	515F500126.....	P224481....	DFLX	5294859.....	X004482....	ECLD	53500420.....	M120225....	BAKO	5401.....		M100049....	TBCR
51300.....	P226140....	DFLX	520197.....	M065065....	INSY		X004482....	CLRK	53500440.....	M100213....	BAKO	540729403.....		M085080....	EINT
51300002.....	P206311....	IR		M065065....	BADG	5300248002.....	M120100....	GILB	53500464.....	M070069....	BAKO	54128.....		P224711....	TRUX
51300010.....	P206410....	IR	520198.....	M065034....	INSY	5300248004.....	M120108....	GILB	53500495.....	M080024....	PETTI	541362.....		M100464....	BRWY
51300622.....	P206336....	IR	520208.....	M070008....	INSY	5300248006.....	M100043....	GILB	53501016.....	M085090....	PETTI	541565.....		M090362....	CAT
51350.....	P226154....	DFLX	52025740.....	M090091....	CANF	5300423.....	M002119....	MOB		M085090....	BAKO			M090362....	BLNT
5136151.....	M080019....	ALSN	52032.....	M100146....	WIRG	5301.....	M090538....	TBCR	53501019.....	M100043....	BAKO	541821.....		P270539....	CAT
	M080019....	DD	520325.....	M080018....	INSY	53017.....	J038612....	WLKR	53501057.....	M120131....	BAKO			P270539....	BLNT
513624.....	M001703....	TMRK	520328.....	M090074....	INSY	53018.....	J038611....	WLKR	53501063.....	M065044....	PETTI	542125.....		P207282....	BLNT
51400.....	P226155....	DFLX	520330.....	M120131....	INSY	5302.....	M120100....	TBCR	53501457.....	P206340....	BAKO			P207282....	CAT
5140018.....	J024754....	DFLX	520331.....	M090158....	BADG	5302277.....	M120154....	GILB	53504057.....	M120131....	BAKO	542199243.....		P206339....	ELECT
5140024.....	J024835....	DFLX		M090158....	BADG	5302277000.....	M120154....	GILB	53504057.....	M120131....	BAKO			M080024....	RVI
5140036.....	J034743....	DFLX	520333.....	M100463....	BADG	5302322001.....	X004484....	GILB	53505476.....	M085207....	BAKO	5430008118.....		P206544....	DFLX
514061.....	M090544....	AGEM		M100463....	INSY	5302322002.....	X004482....	GILB	53505478.....	P206280....	BAKO	5430018S.....		P206544....	DFLX
514228.....	M085078....	AGEM	520340.....	M100048....	INSY	5302322003.....	X004538....	GILB	53505566.....	M100049....	BAKO	5430059046.....		X004482....	RVI
514312.....	P206509....	VOEG	520371.....	M120100....	BADG	5302322004.....	X004478....	GILB	53506181.....	P207283....	BAKO	5430114473.....		M100213....	RVI
514313.....	P206543....	VOEG		M120100....	INSY	5302322004.....	X004478....	GILB	535501D1.....	M002117....	AGEM	5430114924.....		X005207....	RVI
514347.....	X004482....	AGEM	520372.....	M120108....	INSY	53023222.....	X004482....	GILB	535502D1.....	M002120....	AGEM	5430114926.....		P270541....	RVI
514354.....	X004538....	AGEM	520373.....	M080024....	INSY	5303.....	M120365....	TBCR	535671.....	M100464....	BRWY	5430119091.....		M100464....	RVI
514643C1.....	M085008....	NAVI	520376.....	M085008....	INSY	530372.....	M120225....	BADG	5360018.....	P206556....	DFLX	5430127346.....		X004484....	RVI
51500.....	P226157....	DFLX	520379.....	M085023....	INSY	5307171.....	M120365....	GILB	5369070.....	M070008....	MNTW	5430127348.....		M100463....	RVI
5150018.....	J024755....	DFLX	520541C1.....	M090280....	NAVI	5307171000.....	M120365....	GILB	5369120.....	M090009....	MTWC	5430127350.....		P206365....	RVI
5150024.....	J024837....	DFLX	52058.....	P207341....	WLKR	5311178000.....	M120189....	GILB		M090009....	MNTW	5450018S.....		P206547....	DFLX
5150036.....	J034744....	DFLX	5205875.....	P270539....	CLRK	53117778.....	M085008....	WGMC	536917.....	M120100....	MNTW	5454.....		M060037....	HARL
51503.....	M170101....	URIG	52069.....	P206547....	WLKR	531815R1.....	M065030....	FURU	5369170.....	M120100....	MNTW	545546.....		M090074....	CLRK
5157178.....	M060232....	EATN	5208.....	M085008....	TBCR		M065030....	CASE	5369220.....	M080024....	MNTW	54713.....		P207299....	AP
515717800.....	M060232....	NACO	5209070.....	M080018....	CASE		M065030....	KTSU	536933.....	M070050....	MNTW	54714.....		P207300....	AP
51608123.....	X007785....	IR	52092301.....	P206400....	IR		M065030....	DRSS	5369330.....	M070050....	MNTW	54715.....		P206390....	AP
51608131.....	P207331....	IR	5209443.....	P207282....	ECLD	532124C1.....	M120365....	NAVI		M070050....	GRVE	54716.....		P206391....	AP
51608149.....	P270541....	IR	5209756.....	M090158....	VLVO	532347R91.....	M090544....	NAVI	536951.....	X004476....	DAEW	54718.....		P208393....	AP
51616795.....	P207364....	IR		M090158....	CLRK	53247C91.....	M090544....	NAVI		X004476....	SCHAE	54719.....		P207288....	AP
51616803.....	P270539....	IR		M090158....	CLRK	53250.....	P226152....	DFLX		X004476....	NOBEL	54720.....		P207289....	AP
516637.....	X006202....	AGEM	52097862.....	P206344....	IR	532503.....	M070028....	ECLD		X004476....	TIM				

Mfgs. No.	Our No.	Mfg. Code	Mfgs. No.	Our No.	Mfg. Code	Mfgs. No.	Our No.	Mfg. Code	Mfgs. No.	Our No.	Mfg. Code	Mfgs. No.	Our No.	Mfg. Code
54725	P208388	AP	550038382	M100146	CMCO	565477	M065071	BLNT	583966C91	X004538	NAVI	597126	M120131	EMOI
	P208388	TRUX	55006	P226142	WLKR		M065071	CAT	583967C91	X004478	NAVI	597256	M120225	EMOI
54726	P208394	AP	55016620	X004482	TMRK	565478	P270534	CAT	583968C91	X004480	NAVI	597286	M120225	EMOI
	P208394	TRUX	5504	M170101	CYPR		P270534	BLNT	583969C91	X004482	NAVI	59801860	H001039	IR
54727	P208389	AP	55049	M080024	PTBN	5672	P206546	CNLC	583975C91	J009604	NAVI	5987323	M090074	AMEC
54728	P208395	AP	55098	P270541	CRMY	56774953	M120197	IR	583977C91	J009605	NAVI	59902	P270536	GNRC
547379C1	M120176	CUCC	551032	M120108	JHEI	56776198	M120100	IR	583978C91	J009606	NAVI	59939	P270533	GNRC
54764105	M100016	IR	551045	M100465	XAIR	56778699	X004482	IR	5840015	M090535	GRDL	59940	P270538	GNRC
54826	M090280	ECS		M100465	JHEI	56785983	P206410	IR	584173C1	M090781	NAVI	59A2283	P206311	LKBT
548287C1	M100463	NAVI	5510M	M100465	VCOR	56793318	P206345	IR	585171	M085171	JHEI		P206311	FMC
54831	J034744	TRUX	55132	P206403	CRMY	56897978	M120225	IR	585CP	P206510	HDMI	5E2100	P206309	RYGO
548450	M060372	ARV	55133	P207333	CRMY	56927973	P270541	IR	586606C1	M100465	NAVI		P206309	CAT
	P206372	MRMT	55134	P206328	CRMY	56936396	M170101	IR	586607C1	M100465	NAVI	5E7868	P270535	CAT
548540	M085171	JHEI	552046608	P270541	LEBR	5695144	P206508	XAIR	58711B	M080024	KTSU		P270535	TIM
548804C1	M090548	NAVI		P270541	ENMT	56951510	P206512	XAIR	58861444	M090598	IR	5M090595	M090595	JHEI
54906B	M100044	OKSH	5520476	P270540	ENMT	56951585	P206510	XAIR		M090598	VLVO		M090595	ECS
549340	M120108	WGMC		P270540	LEBR	5695159	P206511	XAIR	58877952	J009606	VLVO	5040A	P207394	GRMC
54945	M090544	JHEI	552047608	P270540	ENMT		P206511	ECS		J009606	IR	5PS4174	M120108	CHLN
549464C1	M060232	CUCC		P270540	LEBR	569818	P206641	XAIR					M120108	RCHD
	M060232	NAVI	552070714	H001039	LEBR	56CP	P224492	HDMI	588897896	M085023	UNCT	5Q7026	P270540	CAT
549465C1	M065065	CUCC		H001039	ENMT	57031403	M090535	IR	588897898	X007830	UNCT		P270540	TIM
	M065065	NAVI	552596	P206309	CMPR	57037558	M100465	IR	588897899	P206407	UNCT	5Q7623	H001279	CAT
549468C1	M085008	CUCC		P206309	LROI	57049116	P206339	IR	58932450	P206603	IR		H001279	TIM
549469C1	M085023	NAVI	5525961	P206301	LROI	57165268	X007784	IR	58933623	M085056	SKYJ	5Q7626	P270536	CAT
	M085023	CUCC		P206301	CMPR	57165276	X007785	IR		M085056	IR		P270536	TIM
549470C1	M085023	NAVI	5529992000	P207366	GILB	5717377	P206378	FIVE	58933631	P206340	IR	5Q8753	M100572	CAT
549471C1	M100043	CUCC	55336	P206410	FNEQ	57200B	M090146	OKSH	59075CP	P206511	HDMI	5Q8788	P206327	CAT
549472C1	M100048	CUCC	553832	M100146	CMCO	57200BX	M090146	OKSH	590CP	P206511	HDMI	5XA601	M085208	COUG
549475C1	M090158	CUCC	5540004200	X004539	ATCO	57201B	M070028	OKSH	5910121	M045193	KOEI	5XA605	P270536	COUG
549479C1	M120176	CUCC		X004539	WVGNR	5720341	M065071	FIVE	59137851	P206600	IR			
549480C1	M120189	CUCC	5540175500	M122300	ATCO		M065071	ATHEY		P206600	SKYJ			
549483C1	M100464	NAVI		M122300	WVGNR	5720547	P207347	ELGN	59157701	P206324	IR	600058001	P270543	VMER
549511C91	X004539	NAVI	5540210200	P206607	WVGNR	5721119	P207333	ELGN	59189100	M085090	IR	6000580011	P270543	VMER
549555C91	X004476	NAVI		P206607	ATCO	5721121	P270532	ELGN	5931173	X004484	AMEC	600103001	X006202	VMER
	X004476	CUCC	5540483400	X004962	ATCO	57284	J000202	CRMY	5931174	X004482	AMEC	6001030011	X006202	VMER
	X004476	FURU		X004962	WVGNR	57285	J000203	CRMY	593120081	M001327	KTSU	6002355	M100048	CLRK
	X004476	DRSS	5541095600	P206606	ATCO	57304743	P206280	IR		M001327	CETCO	60026	M065044	GRST
549556C91	X004478	CUCC	5541602	M085056	CMCO	5733008	P206407	KOEI	593121085	P224617	CETCO		M065044	HRCN
	X004478	FURU	5541746600	P206314	ATCO	5735602	P207326	KOEI		P224617	KTSU	6003255	M100464	CLRK
	X004478	DRSS	5542	X004537	CRAN	5735603	P207326	KOEI	5931971	X004480	AMEC	6006049	M090072	CLRK
	X004478	NAVI	5542015000	P206328	ATCO	5735603	P207326	KOEI	59372599	P207281	IR		M090072	VME
549557C91	X004480	FURU	5545	X004478	CRAN	574554601	M085411	ELECT	59372615	P206409	IR	60090ETR	P207366	AJMC
	X004480	DRSS	5546	X004480	CRAN	574554601	P206408	ELECT	594070	M085056	GTMN	60094217	M085090	BROD
	X004480	CUCC	5547	X004482	CRAN	574554801	P207362	ELECT	594270	P206374	GTMN	60094381	M045237	BROD
	X004480	NAVI	5550035	X004536	OMNI	574594701	M002119	ELECT	594271	P206410	GTMN	60094406	M080018	BROD
549558C91	X004482	DRSS		X004536	COMPAC	575480	P206543	ECS	594308	P206370	GTMN	60094519	M090301	BROD
	X004482	FURU	555005016001	P206555	CMI	578068C1	M090563	NAVI	594309	P206322	GTMN	60094542	P224669	BROD
	X004482	NAVI	555005018000	P207283	CMI	579513	P206542	XAIR	594317	P206282	GTMN	600A1016	P206338	AP
	X004482	KTSU	55528	M090595	JHEI	579711	X005207	XAIR	594329	P207326	GTMN		P206338	TRUX
	X004482	CUCC	5554373	X007829	SNKL	57991408	J190003	IR	59450254	M060055	SKYJ	600C1016	P206338	AP
549559C91	X004484	DRSS	5557	P206607	CRAN	57991416	J009645	IR		M060055	IR		P206338	TRUX
	X004484	NAVI	555M045193	M045193	ALMD	57A0936	M100466	FMC	59450262	M065034	IR	6010469	M085056	ECLD
	X004484	FURU	557686	M100463	VLVO		M100466	LKBT		M065034	VLVO		M085056	SISU
549563C91	X004536	DRSS	55945	M090535	JHEI	580136	H001279	HDMA	59456103	P206406	IR		M085056	VALM
	X004536	FURU	559903	P206410	AGEM	58167925	M100463	IR	594610	X004478	GTMN	601354	P270538	Marine
	X004536	NAVI	55CP	P206509	HDMI	58173378	X004484	IR	594647	P207362	GTMN	601355	M090158	Marine
549564C91	X004537	DRSS	5605586	M120131	ENMT	58173386	P206411	IR	594979	M060055	GTMN	601356	P270538	Marine
	X004537	CUCC		M120131	LEBR	58195751	P207322	EIMC	59512814	M080018	IR	602499001	P207332	VMER
	X004537	NAVI	5606629	M120176	LEBR	58195777	P206507	EIMC	595182	M085207	GTMN	6024990011	P207332	VMER
	X004537	FURU		M120176	ENMT	58198235	M100213	IR	595234	M100146	GTMN	602588	P270534	Marine
549565C91	X004538	NAVI	56109	H001035	VLVO	582122C1	M090781	NAVI	59534321	M085008	IR	602616	M065044	Marine
	X004538	FURU		H001035	CRMY	582123C1	M090781	NAVI	59536524	M090159	IR	6031328	M100146	DUHR
	X004538	DRSS	5611585	X004482	ENMT	58259321	P207355	IR	59548594	M045193	IR	603165	P270539	Marine
549611C91	X004539	DRSS		X004482	LEBR	58259329	P207341	IR		M045193	VLVO	603923001	M001503	VMER
	X004539	FURU	563023	P270536	CAT	5826466	X004480	GRDR	595707M91	M090091	AGCO	603924001	M001505	VMER
	X004539	NAVI		P270536	BLNT		X004480	GRDL	59595	P270540	GEHL	6039240011	M001505	VMER
54962	M090544	FWD	563109	P206407	CAT	5826861	M120365	GRDL		P270540	GNRC	604129	P207362	MTWC
54984	P206390	TRUX		P206407	OMML	5826864	M120225	GRDL	5959768	M100049	FLYR	604470	P206372	GTMN
54985	P208393	TRUX		P206407	BLNT	5827462	M090158	GRDL	59626663	M080024	IR	604476	P206321	GTMN
54991	P207288	TRUX		P206407	BLNT	5827628	M120108	GRDL	59626671	M070068	IR	604477	P206345	GTMN
54993	P224710	TRUX	565231	M120131	WGMC	583200338	M080024	CETCO		M070068	VLVO	604534	P206341	GTMN
54CP	P206508	HDMI	565243	P206410	OMML	583964C91	X004537	NAVI	59656553	M060037	IR	604631	P270541	Marine
550038022	M070068	CMCO	5652480	P206385	MNTW	583965C91	X004476	NAVI	59700534	M120108	IR	604809	P206397	GTMN
550038023	M085090	CMCO												

6

Cross Reference

(See first page of this section for Manufacturer's Code Listing)



CROSS REFERENCE

Mfgs. No.	Our No.	Mfg. Code	Mfgs. No.	Our No.	Mfg. Code	Mfgs. No.	Our No.	Mfg. Code	Mfgs. No.	Our No.	Mfg. Code	Mfgs. No.	Our No.	Mfg. Code
604964	X004536	GTMTN	62104526	M090091	NWEG				65297S1	M100043	SEDD	6814910400	M120448	MERS
604965	P206306	GTMTN	62104527	M100016	NWEG	64116798	P206407	EIMC	6530	P206407	XAIR		M120448	FRTL
604966	M045237	GTMTN	62104543	M120225	NWEG	64116949	P206410	TMRK	6535	P206409	XAIR		M120448	CAT
605042	P207364	GTMTN	6211458	P206519	FMC		P206410	SDVK	6540	P206410	XAIR	6814910700	M120450	MERS
605091	P207324	GTMTN	62169	M065030	HRCN		P206410	EIMC	6550	P206411	XAIR		M120450	WSTI
605323	M065044	GTMTN	62182	M080018	HRCN	64118734	P206603	SDVK	65760001	P208338	VMER		M120450	CAT
605337	P206328	GTMTN	62183	M070068	HRCN		P206603	EIMC	657600011	P208338	VMER	6815	M090009	NAVI
605338	M065034	GTMTN	6222668	P207389	LNLD		P206603	TMRK	65805	P270541	GNRC	682684	P270541	TMRK
605358	P206308	GTMTN	622362	P207341	EMOI	64119242	P206347	EIMC	65806	P270543	GNRC	685217	M090544	GM
605405	M090544	AGEM	62244	J190058	HRCN	642050	M065030	FWD	65901	M065065	RKRM	685350L1	M100049	DREO
605409	P206410	AGEM	6224934	M065073	LNLD	6426225	X004482	LEBR	660098	M120100	GM	685478	M100213	TMRK
605441	P206407	AGEM	6230	P206600	XAIR	6426229	X004484	LEBR	66200	X004536	JHEI	685703L1	M120100	DREO
605457	P206319	GTMTN	6232815	M120131	ECLD	6426600	M070068	LEBR		X004536	XAIR	685946	M101182	EMOI
605477	J009640	GTMTN		M120131	VME	6427162	X004480	LEBR	66225	X004537	XAIR	686072	P206603	TMRK
606740	P226149	Marine		M120131	VLVO	64400606	P207667	EIMC	66250	X004476	JHEI	686082	P270541	TMRK
6067122	M065071	FMCO	62332	P207414	HRCN	64544223	X004536	SDVK		X004476	XAIR	686420	M060055	U C
60857703	M085078	LEAR	6235	P206601	XAIR		P206407	EIMC	66275	X004538	JHEI	686424	M090074	U C
60901	M060232	RKRM	623631226X1	P270538	FURU	64558024	M090091	SDVK		X004538	XAIR	687820	P206283	U C
60B/M1357	P270541	AA		P270538	DRSS	64572841	M045237	SDVK	66300	X004478	XAIR	687824	P206312	U C
60EST	J000218	ACFT	6240	P206602	XAIR	64673	P216202	TRUX		X004478	JHEI	687828	P206344	U C
60FBC	P207598	ACFT	6250	P206603	XAIR	64804136	M100146	EIMC	663283	M090074	GM	687832	P206348	U C
60FBZ	P207596	ACFT	62548	M090091	HRCN	64804786	M065071	EIMC	6633766	P270532	CLRK	687836	P206407	U C
60GZ	P207667	ACFT	6260	P207596	XAIR	64806596	M080018	EIMC	66350	X004480	TESSI	687840	P206410	U C
60PLA	J190055	ACFT	62712	J190042	HRCN		M080018	SDVK		X004480	XAIR	687844	P206411	U C
60PLS	J190063	ACFT	6299	J190014	NH	648808	X004536	MCHC		X004480	JHEI	687860	P206602	U C
60RCZ	P270543	ACFT	62W2269	M090159	KOOT	648810	X004537	MCHC	66362	X007829	NOBEL	687864	P206850	U C
60STA120	P206338	ACFT	62W9012	M080018	KOOT	648812	X004476	MCHC		X007829	SCHAE	687868	P207361	U C
60X50CS148C	P207321	PACC	6300	P207363	NH	648814	X004538	MCHC	66400	X004482	TESSI	687876	P207596	U C
60X50CS160C	P207302	PACC	631204500	X004482	VH	648816	X004478	MCHC		X004482	JHEI	687884	P208393	U C
60X50CS196C	P209910	PACC	631204510	J024836	VH	648820	X004482	MCHC		X004482	XAIR	687888	P206603	U C
60X50CS248C	P206387	PACC	6317331	P206328	NABI	648822	X004484	MCHC	66496	P207362	TYLE	688557	M090301	TMRK
60X50CS260C	P208395	PACC	6320	J000220	XAIR		X004484	CNLC	66500	X004484	XAIR	689132	X004484	U C
60X50R106A	P207402	ACFT	63229	M120418	HRCN	64955	P206315	HRCN		X004484	JHEI	689136	X004536	U C
610	M065065	AP	63238	M060037	WKSA	64956	P206317	HRCN		X004484	TESSI	689164	X006202	U C
6100481	P206282	TIPP	63239	P270533	GNRC	65013S1	M120365	SEDD		X007785	JHEI	689168	X004484	U C
61192	P270531	GNRC	6325	J000221	XAIR	65119192	M060037	CLJL	66500F	X004539	TESSI	689172	X004539	U C
61225	X004537	TBCR	6330	J000227	XAIR		M060037	CLRK	66600	X004539	TESSI	689176	X006203	U C
61240007	M120154	TBBI	6335	J000228	XAIR	651562	J190042	LROI		X004539	JHEI	69000400	P206849	EIMC
61240011	M110674	NAVI	63361	P270838	CRAN		J190042	CMPR	669473	P206404	CLJL	69008773	X004537	SDVK
	M110674	FRTL	6340	J000230	XAIR	651563	P207326	CMPR	66U13753	X004478	TCLD		X004537	TMRK
	M110674	TBBI	63407	P206369	HRCN		P207326	LROI		X004478	CALD	69008774	M170101	EIMC
61240015	M085171	TBBI	63462	P207355	HRCN	651567	P206280	LROI	66U1375301	X004536	TCLD	69008926	P222751	SDVK
61240016	M085078	TBBI	6350	J000232	XAIR		P206280	CMPR		X004536	CALD	69013569	X004476	EIMC
61240169	M120713	TBBI	63510	M060250	EAGP	651570	P207362	LROI	66U21491	M045237	CALD	69015849	X004536	EIMC
61240385	P206311	TBBI		P206374	HRCN		P207362	CMPR	671732	M090158	TMRK		X004536	SDVK
61250	X004476	TBCR	63552040	P206556	KTSU	651571	J008681	CMPR	671733	M120225	TMRK		X004536	TMRK
61275	X004538	TBCR		P206556	MH		J008681	LROI	67362	M080024	ATHP	69033512	P207366	EIMC
61300	X004478	TBCR		P206556	DMAG	651575	P207366	LROI	67496	M060158	WLDN		P207366	SDVK
61350	X004480	TBCR	63552140	X004539	MH		P207366	CMPR	6751378	M120100	AMLF		P207366	TMRK
61400	X004482	TBCR		X004539	DMAG	651581	P207408	CMPR	676533	M100464	GM	69040237	P206340	SDVK
614042724	P226152	CAM		X004539	KTSU		P207408	LROI	6772134	X004480	VLVO	690420R91	M120100	NAVI
	P226152	PRIN	63586	P206370	HRCN	6519192	M060037	CLJL	6772734	X004480	VME		M120100	CASE
61500	X004484	TBCR	63696S1	M070069	SEDD		M060037	CLRK		X004480	VLVO		M120100	CUCG
61573	P216175	HRCN	63898	P207282	HRCN	651997	M100049	GM		X004480	ECLD	691318	M100464	GM
61574	P206338	HRCN	640001	J640001	AP	652468	P207365	LROI	6779670	X004478	ECLD	69427B	M100463	OKSH
61599	P207408	HRCN	640008	P224600	AP		P207365	CMPR		X004478	VME	69445089	M045237	AGEM
61600	X009076	HRCN	64045	P207402	HRCN	6524682	P207365	LROI		X004478	VLVO	6953201	M065030	TRJN
	X004539	TBCR	64101298	P206408	EIMC	6524682	P207365	LROI	680013	M070008	NAVI	695423	M100464	GM
617890001	M001668	VMER		P206408	TMRK	652469	P207283	CMPR	680033	M070050	NAVI	695424	M100048	GM
6181929	M100572	ELGN		P206408	SDVK		P207283	LROI	68010	M100464	NAVI	69941B	M100465	OKSH
	M100572	ATHEY	64106179	X004478	EIMC	652474	P206346	CMPR	680400	M065065	TMTR	69941BX	M100465	OKSH
6187303	M085023	ATHEY		X004478	SDVK		P206346	LROI	680401	M100048	TMTR	69A0122	M085056	FMC
	M085023	ELGN	64106591	X004539	EIMC	652475	P207282	CMPR	680402	M120100	TMTR		M085056	LKBT
6202245	M060037	FMC		X004539	SDVK		P207282	LROI	6804900201	M110148	MERS	6A1145	M080024	PETTI
62027	M065030	HRCN		X004539	TMRK	652490	P206344	LROI		M110148	FRTL	6HD247	P206410	OKSH
6202728	M065030	FMC	64106592	X007785	TMRK	652491	P206362	LROI	6804900401	M110112	MERS	6I0144	X007805	BABR
6203000009	X004484	MLS		X007785	EIMC	6524911	P206361	LROI	68106374	P207596	TMRK		X007805	CAT
6203000013	M090595	MLS	64106599	X004480	SDVK		P206361	CMPR		P207596	SDVK	6PS4174	M090535	CHLN
6203577	P270536	ELGN		X004480	EIMC	652492	P206554	LROI		P207596	EIMC		M090535	RCHD
6206115910	X007829	KTSU	64106926	X004482	EIMC	652493	P206326	CMPR	6811502	M080018	CDIV			
6210449200	P206603	KOEH		X004482	SDVK		P206326	LROI	6811503	P206600	CDIV			
6210451550	M120365	NWEG		X004482	TMRK	652504	P207322	LROI	68122680	P226140	EIMC			
62104524	M090009	NWEG	64108268	P206411	SDVK	652535	P207341	LROI	68122681	X004478	SDVK			
				P206411	EIMC		P207341	CMPR						

(See first page of this section for Manufacturer's Code Listing)

CROSS REFERENCE

Mfgs. No.	Our No.	Mfg. Code	Mfgs. No.	Our No.	Mfg. Code	Mfgs. No.	Our No.	Mfg. Code	Mfgs. No.	Our No.	Mfg. Code	Mfgs. No.	Our No.	Mfg. Code
7000073228	M060247	KBTA	70P207326	P207326	AST	7300001003	X004536	MTWC	7412010800	M120108	CHARD	76048156	X004478	BADG
7000302389	X004482	IKRS		P207326	ASTEC		X004536	GRVE	7412018600	M120365	CHARD	76049046	M100043	BADG
7000320364	P206364	IKRS	70P207402	P207402	AST	7300100029	X007833	GRVE	741238002	P206409	AGEM	76050047	X004476	BADG
7000320411	P206411	IKRS		P207402	ASTEC	73061486	M100043	FIAT	7413123	H001034	LEBR	76050048	X004538	BADG
7000327541	P270541	IKRS	7100090	M100049	KOEH		M100043	CASE		H001034	ENMT	76051472	X004482	BADG
700353500	H001284	KOEH		M100049	TREX	73061656	M100043	NH	74131239814046	H001034	LEBR	76054143	M090091	BADG
	H001284	TJAK	71040225	P270534	TJMG		M085023	FIAT	7413740	H001032	LEBR	76059877	M100146	BADG
	H001284	JNDR	7115108	P207362	HOIST	73061668	M085023	NH	7415294	M070069	LEBR	76062464	M085078	BADG
700701176	P206555	NH	71173007	M100146	GRDL		M085023	FIAT	7415447	P206544	LEBR	76065186	M085171	BADG
	P206555	FIAT	712000	M085008	KMBL	73111489	X004478	FIAT	7415448	P207386	LEBR	76066741	J009648	BADG
	P206555	CASE	712004	M070069	KMBL		X004478	CASE	7420053400	P270534	CHARD	76067164	X004484	BADG
700701264	P207419	CASE	712005	M080024	KMBL		X004478	NH	7420134600	P206406	CHARD	76072056	M100572	BADG
	P207419	FIAT	712042	M070068	KMBL	73121002	H001033	NH	7420500200	P270532	CHARD	76072870	M100463	BADG
	P207419	NH	71316859	H001279	AGCO		H001033	FIAT	7420500600	P270536	CHARD	76079257	M120365	BADG
700702200	X004539	CASE	7133300	X004536	KARP	73182	M091047	RSCO	7420500700	P270538	CHARD	76079720	M090544	BADG
	X004539	FIAT	7133400	X004537	KARP		M091047	BRLEE	74350C	P270582	DFLX	76080439	M085090	BADG
	X004539	NH	7133500	X004476	KARP	73183	M002120	RSCO	7450000092	P206612	MTWC	76080988	J034673	BADG
700715571	X007830	CASE	7133600	X004538	KARP		M002120	BRLEE		P206612	GRVE	76082813	M100049	BADG
	X007830	AGCO	71337	M100049	FLYR	73184	J190044	BRLEE	7450000109	P206615	GRVE	76084889	P206600	FIAT
	J240004	CASE	7133700	X004478	KARP		J190044	RSCO		P206615	MTWC	76085702	M002121	BADG
	J240004	AGCO	7133800	X004480	KARP	73185	J190014	BRLEE	7450000166	P206615	GRVE	76093320	J009637	BADG
700716741	P206319	HAY	7133900	X004482	KARP		J190014	RSCO	745017	P207581	DYPC	76093321	P206311	BADG
	P206552	CASE	7134000	X004484	KARP	73331	M100464	FDQN	750	M090091	EAGL	7611247	P206410	LEBR
	P206552	HAY	71368964	P206365	AGCO	733870	M001503	CAT	75024	P206411	FMHD	76164	M085090	PBRN
	P206552	AGCO		P206365	AGCO	7362899	X004484	ENMT	7510057	M100043	PTBM	761880010	X004484	HRSN
700717720	P207322	CASE		P270540	HAY		X004484	LEBR	7524005210	P206411	GE	7618810	X004484	HRSN
	P226144	AGCO	71405382	X004476	HHTH	736289903	X004484	LEBR	753980C1	M090535	NAVI	7618812	X004478	HRSN
	P226144	HAY		X004476	FIAT	7364001293	P206315	MTWC	753980C91	M090074	CUC	761889	X004482	HRSN
	P207402	AGCO	7140871	M100466	TREX		P206315	GRVE		M090074	NAVI	7621247	P206602	LEBR
700727325	P207402	HAY		M100466	KOEH	7364001704	P206326	MTWC	7567407803	P206367	IR	7621826	P206601	LEBR
	P207402	AGCO	7146489	P270541	TYLE		P206326	GRVE	7567507802	P206600	IR	7624000028	M090535	GRVE
7009031763	P271507	KBTA	716177	M120108	KSHA	7365029	X004539	ENMT	76009164	M070008	BADG	7624000049	M100465	GRVE
	H001279	JNDR	7170177	M100465	KOEH		X004539	LEBR		M070008	GRDL	762782C92	M120108	NAVI
701046200	H001279	TJAK		M100465	TREX	7365810	P270541	ENMT		M070008	WRNR	762783C91	M100048	CUC
	J009514	MTWC	717202	M120197	GM		P270541	LEBR	76018489	M070068	BADG	7630255	M060158	OMNI
	J009514	GRVE	717214	M100464	GM	7366270	P206323	LEBR		M070068	WRNR	7630255	M060158	OMNI
70170	P207369	HRCN	717217	M100464	GM		P206323	ENMT	76018805	M085056	WRNR	763196C91	M090074	NAVI
	P206850	IR	717308	M090535	GM	73671042	M090210	GRDL		M085056	BADG	763C003	P207367	SIGM
70177	P206850	IR	718051	M100464	GM	7368830	P271511	LEBR	76018849	P206407	BADG	764077	M065074	TENT
7018	M085008	CASE	718CP	P206641	HDMI	7368952	P207667	LEBR		P206407	GRDL	764120	P270534	TENT
70199467	P206410	MIIN	7200	M060037	ME		P207667	ENMT	76020614	M045237	BADG	7642000025	M065034	GRVE
	P206410	FIAT	720000	M045237	AGEM	7369271	P206411	LEBR		M045237	WRNR	7642000027	M090544	GRVE
	P206410	NH	72003655	M060037	ME		P206411	ENMT		M045237	GRDL	7642000028	M090535	GRVE
70202	P206337	HRCN	720190011	M100463	VMER	740	M080024	EAGL	76022356	M085023	BADG	7642000031	M090170	GRVE
	P206337	HRCN	72112	M090280	BRLEE	7400448200	X004482	CHARD		M085023	GRDL	7642000036	M090146	GRVE
7024938	P206410	FIAT	72113	M090280	RSCO	7401755	P270543	LEBR	76018849	P206407	BADG	7642000040	M070008	MTWC
	P206410	NH	72113	P206311	RSCO		P270543	ENMT		P206407	GRDL	7642000049	M100048	GRVE
703130	M065071	SHUT		P206311	BRLEE	7404512300	M045123	CHARD	76025334	M085008	GRDL	7642000053	M100048	MTWC
	M060037	GRVE	721239005	P206410	AGEM		M100016	ENMT		M085008	WRNR	7642000054	M091046	GRVE
703700002	M060037	GRVE		X004480	OK	7404783	M100016	LEBR	76026291	M120108	BADG	7642000055	M100464	GRVE
7037000504	M070069	GRVE	7221516	X004480	TREX		P207339	MTWC		M120108	GRDL	7642000056	M090544	GRVE
	M070069	MTWC		X004480	TREX	7406000151	P207339	GRVE	76026399	P206409	BADG	7642000057	M100463	GRVE
7056100001	M002122	MTWC	72525770	P207339	AGCO		P207339	GRVE		M120108	WRNR	7642000058	M090535	GRVE
	M002122	MTWC	7258000828	P270530	GRVE	7406000158	P206340	GRVE	7602691	M120108	GRDL	7642000059	M085090	GRVE
7056100010	M002119	GRVE	7258000829	P270531	GRVE	7406000163	P207332	GRVE	76027177	P206411	GRDL	7642000060	M090535	GRVE
706186	M120365	GM	727321001	M110012	JNDR	7406000179	P207351	MTWC		P206411	GRDL	7642000061	M090170	GRVE
707024722	P270539	FIAT	728599	M090535	TREX		P207351	GRVE	76031368	M100049	BADG	7642000062	M090170	MTWC
	P270539	CASE	7300000073	P206410	GRVE	7406000304	P206400	GRVE	76032138	M100049	WRNR	7642000063	M085226	GRVE
	P270539	NH	7300000074	P206409	GRVE		P206400	MTWC		M100049	WRNR	7642000064	M085226	MTWC
708799512	X004484	CASE	7300000109	P206406	GRVE	7406000443	P206310	GRVE	76034168	M120176	BADG	7642000065	M070008	GRVE
	X004484	FIAT	7300000177	X004478	MTWC		M100016	LEBR		M120176	BADG	7642000066	M100463	GRVE
	X004484	NH		X004478	GRVE	74060019400	M060158	CHARD	76036048	M070069	BADG	7642000067	M100464	GRVE
70930	M090594	RDRL	7300000185	X004482	GRVE		M065030	CHARD		M070069	BADG	7642000068	M100464	GRVE
	X004476	AGEM		X004482	MTWC	74060504400	M065044	CHARD	76036827	M080024	BADG	7642000069	M100464	GRVE
709385	X004476	RDRL	7300000194	X004484	MTWC		M065044	CHARD	76039812	M070068	BADG	7642000070	M060158	GRVE
	X004476	RDRL		X004484	GRVE	7300000211	X004480	MTWC	76040807	M090158	BADG	7642000071	M060158	MTWC
70DD3852	P206601	AA	7300000272	X004476	MTWC		X004480	MTWC	76040807	M090158	BADG	7642000072	M090210	GRVE
	P206601	AA		X004476	GRVE	7300000272	X004476	GRVE	76043380	M090544	BADG	7642000073	M100463	MTWC
70M080024	M080024	ASTEC		X004476	GRVE		X004476	GRVE	76045587	M120131	BADG	7642000074	M100463	MTWC
	M080024	ASTEC	7300000272	X004476	MTWC	7300000272	X004476	GRVE	76046685	M100463	BADG	7642000075	M090210	GRVE
70P206316	P206316	AST		X004476	GRVE		X004476	GRVE	76046734	X004480	WRNR	7642000076	M090210	MTWC
	P206316	ASTEC	7300000971	X004476	MTWC		X004480	BADG		X004480	BADG	7642000077	M120176	GRVE
	P206316	ASTEC		X004476	GRVE	7410004800	M100048	CHARD	76047417	M100049	BADG	7642000078	M120131	GRVE
70P206343	P206343	AST		X004476	GRVE	7410340								

Cross Reference

(See first page of this section for Manufacturer's Code Listing)



CROSS REFERENCE

Mfgs. No.	Our No.	Mfg. Code	Mfgs. No.	Our No.	Mfg. Code	Mfgs. No.	Our No.	Mfg. Code	Mfgs. No.	Our No.	Mfg. Code	Mfgs. No.	Our No.	Mfg. Code	
764200059	M090210	GRVE	78152	M045237	LROI	7GB010	M100464	WGMC	809530	J009560	TRUX	81922	M090538	RKRM	
764200061	M090301	MTWC	78157	M070028	LROI		M090544	VLVO	809544	P206342	TRUX	81923	M090563	RKRM	
	M090301	MTWC	78158	M070050	LROI	7LT400	M090362	RKRM	809545	P207345	TRUX	8198	J009649	BLNT	
764200062	M090158	GRVE	781670	P206319	DYPC	7N1087	M001566	CAT		P207345	GOE	82033810	M090589	GRDL	
	M090158	GRVE	78254	M100464	LROI	7TU01112	P206851	AA		P207345	AP	82034108	M070068	CASE	
764200068	M120235	GRVE	78268	M060158	CMPR	7TU01113	P226148	AA	809546	P207346	TRUX	82034547	M090159	BADG	
	M120235	MTWC		M060158	LROI				809547	J009547	TRUX	82082010026	P206851	MAN	
764200075	M065044	GRVE	78272	M080024	LROI				809621	P207345	TRUX	82082010028	P206338	MAN	
	M065044	MTWC	78273	M100580	LROI				80973013	M101169	GRDL	8213187000	X004484	GILB	
764200080	M070028	GRVE	78283	M100016	CMPR				809736	P206282	TRUX	8213187000	X004484	GILB	
	M070028	MTWC		M100016	LROI				809737	J190023	TRUX	82151010021	M090535	MAN	
764200088	M090544	GRVE	782862	M085056	CMPR				809738	P206346	TRUX	82152010054	P206400	MAN	
	M090544	MTWC		M085056	LROI				809739	P206283	TRUX	82152010056	P206337	MAN	
764200099	M100048	GRVE	78287	M090091	LROI				809750	P207353	TRUX	82152010060	P208375	MAN	
764200093	M090594	MTWC	78294	M100146	CMPR				809752	P216169	TRUX	82152010062	P206540	MAN	
	M090594	GRVE		M100146	LROI				809769	P206343	TRUX	82152010003	P226143	MAN	
764200056	M120176	GRVE	78295	M085208	LROI				809770	P207345	TRUX	82152150017	P206540	MAN	
764200063	M100465	GRVE	78300C	P206604	DFLX				809771	J009547	TRUX	82155016001	P206611	MAN	
	M100465	MTWC	78312	M065044	CMPR				809793	P207364	TRUX	82155016002	P206511	MAN	
764200069	M120100	MTWC		M065044	LROI				809796	J190019	TRUX	82155016003	X006202	MAN	
	M120100	GRVE	78314	M120225	LROI				8100075	X007784	TIPP	8225975000	M090072	GILB	
7642000610	M090146	GRVE	78318	M085090	LROI				81004	M090074	RKRM	8227489000	P206369	GILB	
7642000640	M080018	GRVE	783181	M085090	LROI				81005	M090158	RKRM	8229364000	X004480	GILB	
	M080018	MTWC	78325	M100146	LROI					P206336	ROSS	8238488000	P206602	GILB	
764200068	M120235	GRVE	784120014X1	M085208	CETCO				81006	M090158	RKRM	8238889000	P206328	GILB	
764210000	M045237	GRVE	7842001825	M100146	GRVE				81008	M090280	RKRM	8239673000	P206507	GILB	
764210001	M060055	GRVE		M100146	MTWC				810090220	X007829	MNTW	824001	J014622	TRUX	
764210004	M110479	MTWC	78491	M065044	PBRN				810803400	M090210	TJAK	824002	P224633	TRUX	
	M110479	GRVE	78500C	P206604	DFLX					M090210	JNDR	824004	P208338	TRUX	
	P206321	GRVE	78626181	M045193	AGCO				8108214	M080024	EATN	824006	J240024	TRUX	
764210007	M065030	MTWC		M045193	DETZ				810821400	M080024	TJAK	824607	P206405	CLJL	
	M065030	GRVE		M045193	KLMA				810821600	M100146	EATN	824701	P207283	TRUX	
764210008	M060037	GRVE	788022C1	M120131	NAVI					M100146	JNDR	824715	J024757	TRUX	
764210009	M120566	GRVE	78M065044	M065044	HARLEY				810850800	M070068	TJAK	824716	P207309	TRUX	
	M120566	MTWC	78M100572	M100572	HARLEY				811175700	M070028	JNDR	824721	J024749	TRUX	
7642100013	M120382	GRVE	78M120225	M120225	HARLEY					M070028	TJAK	824722	J024751	TRUX	
	M120382	MTWC	79018666	P270535	NH				8112017	X004478	FLYR	824738	P224627	TRUX	
7642100021	M120225	MTWC		P270535	FIAT					X004478	NEWFLY	824749	J024749	TRUX	
	M120225	GRVE		P270535	CASE				8112018	X004480	FLYR	824751	J024751	TRUX	
7642100022	M100213	GRVE	79028227	H001032	CASE					X004480	NEWFLY	824757	J024757	TRUX	
7642100024	M101181	GRVE		H001032	NH				81152046054	P270541	MAN	824758	J024758	TRUX	
7642100026	M101158	GRVE		H001032	HHTH				81152046060	P270540	MAN	8249296000	X004539	GILB	
	M101158	MTWC		H001032	FIAT				81155016001	P206611	MAN	826337	P206410	Americ	
7642100035	M120450	GRVE	7905	P270534	WIRG				811870600	X007784	CAT		P206411	AMHO	
7642100042	M085409	MTWC	790758	P206406	CLJL					X007784	TJAK	827125	P206411	Americ	
	M085409	GRVE	79076459	H001034	NH				811870700	X007784	BLNT	8275035	M065073	TRAK	
7642800000	M100048	GRVE		H001034	HHTH					J190062	BLNT	827745	M065073	TRAK	
7642995001	M100146	GRVE		H001034	FIAT					J190062	JNDR	82976411	H001033	TREX	
76685A	M100049	OKSH		H001034	CASE					J190062	CAT	831012S	P206542	DFLX	
769184	P270536	TENT	7910009098	P207354	GRVE				81377789	M085078	TMRK	832419	H001284	AGEM	
7697000164	P206345	GRVE		P207354	MTWC					M085078	EIMC	834002	P224698	TRUX	
7700054646B	M001503	RVI	794299	M100213	IVECO					M085078	DLTC	834004	P224628	TRUX	
7700054689	X004482	RVI	79434	M065034	WLDN				814051	M065034	DYPC	834005	J340023	TRUX	
7700059654A	M001702	RVI	794982	M090158	IVECO				814204	M070050	AMHO	834006	P224581	TRUX	
770062689	M001502	RVI	795570C1	M120108	CUC				81421009	M090158	DLTC	83471074	M070069	GRDL	
7701030196	P206343	AMC		M120108	NAVI				814621	J014621	TRUX	834727	P208359	TRUX	
	P206343	XMTN	798803	M090538	GM				814622	J014622	TRUX	834728	P208375	TRUX	
770460000	M060055	PETTI	799118	M080018	DYPC				814623	J014623	TRUX	834746	J034746	TRUX	
770512A05	M085023	GRDL	799121	X004478	DYPC				814662	J014622	TRUX	834747	P216204	TRUX	
77118	M080018	DYPC	7C1377	X007831	CAT				815014	P270534	TIM	83476	P206409	LROI	
77173007	M100146	GRDL		X007831	RYGO				815743	X007829	CAT	834779	P216227	TRUX	
7718810	X004484	HRSN	7C4500	X007830	CAT					X007829	BROW	8355742	M085078	DUHR	
7734006685	J190042	GRVE	7C7009	X007784	CAT				81589079	X005207	LORR	8355910	M100043	DUHR	
7734006686	P206319	GRVE	7E0114	M080019	CAT					X005207	LRAN	835866	M090074	WGMC	
77383601	H001034	GRDL	7E1397	M001505	CAT					H001032	DLTC		M090544	VLVO	
77383778	M100572	GRDL		M001505	TIM				8167807	X004484	VLVO	83610	P206410	LROI	
	M100572	JLGI	7E3870	M001503	TIM				8182600	M002164	UPTI		P206410	CMPR	
7806300	X004539	KARP		M001503	CAT				81906	M090158	RKRM	836309	M080024	AMHO	
78103131	M100048	BADG		M001503	EAGP				81908	M090280	RKRM	836310	M100048	AMHO	
78111	M090009	LROI	7E6455	M001504	CAT							83671042	M090210	GRDL	
781111	M090009	LROI		M001668	CAT										
78140	M070008	LROI	7E9506	M001504	CAT										
78147	M060005	LROI													

(See first page of this section for Manufacturer's Code Listing)

Mfgs. No.	Our No.	Mfg. Code	Mfgs. No.	Our No.	Mfg. Code	Mfgs. No.	Our No.	Mfg. Code	Mfgs. No.	Our No.	Mfg. Code	Mfgs. No.	Our No.	Mfg. Code	
83671149	X004480	GRDL	84441	X004478	LAWSON	854715	P206390	TRUX			P206409	BLNT	86500	M090091	DFLX
83671225	M070069	GRDL	84442	X004480	LAWSON	854723	P207301	TRUX	86130M	M100463	NLSN	86500M	M110012	NLSN	
83683097	X007785	GRDL	84443	X004482	LAWSON	854724	P207302	TRUX			M100465	NLSN	86502M	M110189	NLSN
83683175	P206405	GRDL	84444	X004484	LAWSON	854727	P208389	TRUX	86131M	M090544	NLSN	865034C91	M100049	NAVI	
83713009	X007784	GRDL	84466	X004539	LAWSON	854728	P208395	TRUX	86132M	M090074	NLSN	86503M	M120366	NLSN	
	X004482	WRNR	844661	P206388	TRUX	854830	P224693	TRUX	86133M	M100049	NLSN	86507M	M065065	NLSN	
8374280546	H001033	KAEL	844663	P206389	TRUX	85500CP	P206509	DFLX	86134M	M085008	NLSN	86510M	M090547	NLSN	
83746	P206409	CMPR	844668	P207320	TRUX	85803795	M065030	NH	86136M	M060055	NLSN	86511573	P206409	NH	
83747	P207667	LROI	844669	P206386	TRUX		M065030	CASE		M060232	NLSN		P206409	CASE	
	P207667	CMPR	844670	P207321	TRUX	85804014	P270534	NH	86137M	M065065	NLSN	86511M	M090548	NLSN	
83816	M060055	WLDN	844671	P206387	TRUX		P270534	CASE		M065034	NLSN	86512M	M090520	NLSN	
83890	P206411	LROI	844734	P207318	TRUX		P270534	FIAT	86139M	M085023	NLSN	86513M	M090563	NLSN	
	P206411	CMPR	844735	P207319	TRUX	85805478	M065030	NH	8613U	M090544	TYLR	86514M	M090781	NLSN	
83931	X007785	LROI	844737	P207312	AP		M065030	FIAT	86144M	M090362	NLSN		M090781	GRMC	
839312	X007829	LROI		P207312	TRUX		M065030	CASE	86145M	M090072	NLSN	86515M	M065065	NLSN	
839313	X006204	LROI		P207312	GOE	85821055	M085084	CASE	86147M	M120225	NLSN	86518M	M065065	NLSN	
83947685	X004536	CASE	845100207	M070008	KOEH		M085084	NH		M120108	NLSN	86521M	M085023	NLSN	
	X004536	FMCO	84546	P209913	AP		M085084	FIAT	86148M	M100146	NLSN	86522M	M085172	NLSN	
	X004536	FIAT	84584	P206302	AP	85821060	X004478	FIAT	86149M	M120382	NLSN	86525M	M085189	NLSN	
	X004536	NH	84585	J000127	AP		X004478	CASE	86150	M060038	DFLX	86526M	M100213	NLSN	
83AX1039	P206603	MAACK	846100205	M060005	CAME	85821061	X004480	CASE	86150M	M070028	NLSN	86529M	M110189	NLSN	
840031	M090280	TREX		M060005	KOEH	859003CP	P206511	DFLX	86151M	M100052	NLSN	86530M	M110311	NLSN	
	M090280	AMHO	846100207	M070008	KOEH	85900RCP	P206511	DFLX	86152M	M100464	NLSN	86531M	M100580	NLSN	
841041S	X005207	DFLX		M070008	CAME	85901	M085171	RKRM	86153M	M090534	NLSN	86533M	M100580	NLSN	
841074700	X007831	TJAK	846100209	M045237	KOEH	85903	M085008	RKRM		M090280	NLSN	86535M	M100695	NLSN	
	X007831	JNDR	846100243	M085023	KOEH	85904	M085080	RKRM	86163M	M065065	NLSN	86536M	M090680	NLSN	
	X007831	CAT	846100247	M085023	BRLEE	85923	M085172	RKRM	86168M	M100048	NLSN	86537M	M090547	NLSN	
	X007831	BLNT		M085023	RSCO	85924	M085189	RKRM	86172M	M060005	NLSN	86538M	M090563	NLSN	
841076000	X004478	CAT		M085023	CAME	85925	M085023	RKRM	86173M	M070008	NLSN	86539	M065065	NLSN	
	X004478	BLNT	846100273	M065065	KOEH	85GH18CP	P206641	DFLX	86174M	M070050	NLSN	86541M	M110012	NLSN	
	X004478	JNDR		M065065	RSCO	85SC6003Z	P224492	DFLX	86175M	M090009	NLSN	86542M	M120566	NLSN	
	X004482	TJAK		M065065	BRLEE	86025101	X007784	NH	86177M	M045237	NLSN	86543M	M120713	NLSN	
841087100	X004482	JNDR	846100279	M100464	KOEH		X007784	BVER	86178M	M065071	NLSN	86544M	M100466	NLSN	
	X004482	AMERIC	846100283	P206311	CAME		X007784	CASE	86179M	M090280	NLSN	86545M	M090548	NLSN	
841389	P206407	Americ		P206304	CAME	86025102	X007785	BVER	86180M	M122300	NLSN	86547M	M100695	NLSN	
841600207	M070008	KOEH	846100287	P206302	CAME		X007785	EARN	86183M	M085172	NLSN	86548M	M090547	NLSN	
842167	X004538	AMHO	846100292	M090158	BRLEE	86032538	P207596	BVER	86184M	M085189	NLSN	86560M	M090594	NLSN	
	X004539	Americ		M090158	RSCO	86034576	M090072	BVER	86185M	M090563	NLSN	86563M	M090158	NLSN	
84217668	M001502	CASE		M090158	CAME	8605331	M002122	CASE	86186M	M085407	NLSN	86571015	M070050	WRNR	
842434	M190002	Americ	846100328	J024748	CAME	8608	J000224	AP	86190M	M060481	NLSN		M070050	GRDL	
842954800	P206325	TJAK	846100344	X004484	CAME	8609	J000227	AP	86191M	M065044	NLSN	86571018	M080024	WRNR	
842964800	P206325	BLNT		X004484	KOEH	86102M	M090535	NLSN	86192M	M085084	NLSN		P206410	GRDL	
	P206325	JNDR		X004484	CAME	86106M	M090158	NLSN		M085090	NLSN	86624M	M090544	NLSN	
	P206325	CAT	846100359	M090146	CAME	86108M	M090544	NLSN		M085206	NLSN	86626M	M100807	NLSN	
	P206325	TJAK	846100379	M100464	KOEH	86111M	M100464	NLSN	86193M	M090301	NLSN	86631M	M090680	NLSN	
842973900	M090301	JNDR	84656	M001668	KTSU	86113M	M090146	NLSN	86194M	M120235	NLSN	86643883	X007784	CASE	
	M090301	CAT	846850	M090158	AMHO		M090146	TAC	86195M	M100465	NLSN	86644K	M110189	NLSN	
	M090301	TJAK	848101164	H001278	KTSU	86115M	M120154	NLSN	86196M	M100582	NLSN	86644M	M110189	NLSN	
	M090301	BLNT	8483	P206507	AP	86116	J000228	AP	86200	M060037	DFLX	86650M	M110012	NLSN	
842974000	P206310	BLNT		P206507	TRUX	86117M	M120131	NLSN	86200M	M100464	NLSN	86653M	M110012	NLSN	
	P206310	TJAK	85071213	M070008	GRDL	86118M	M120365	NLSN	86203M	M120197	NLSN	86657M	M090170	NLSN	
	P206310	JNDR		M070008	WRNR	86119M	M100043	NLSN	86206M	M090210	NLSN	86660M	M110189	NLSN	
842974100	P206601	BLNT	850982	P270532	AGEM	86119M	M085080	NLSN	86213M	M090538	NLSN	86661M	M090280	NLSN	
	P206601	CAT	85106083	X007785	VLVO		M085078	NLSN	86215M	M100464	NLSN	86662M	M100043	NLSN	
	P206601	JNDR	85107180	M090544	VLVO	8612	J000230	AP	86216M	M090146	NLSN	86668M	M090563	NLSN	
	P206601	TJAK	85107544	X007805	VLVO	86121M	M120131	NLSN	86220M	M120367	NLSN	86669M	M090520	NLSN	
842974200	P206600	JNDR	85131016	M085008	WRNR		M120176	NLSN	86225	M120197	AMHO	86671417	M070050	WRNR	
	P206600	BLNT		M085008	GRDL	86125M	M120100	NLSN	86240012	P206397	TBBI		M070050	GRDL	
	P206600	CAT	851SA1930	M070050	CLRK	86127M	M085171	NLSN	86240013	P206326	TBBI	86671583	P206601	GRDL	
	P206600	TJAK	853030041	M100572	CETCO	8612947	P206327	BLNT	86250	M065030	DFLX	86671607	M070068	GRDL	
843006400	P206311	JNDR	8533345	X004484	FMNT	8612944	M070069	CAT	8626181	M045193	DETZ	86672M	M110014	NLSN	
	P206311	TJAK	854000	P207318	TRUX		M070069	BLNT		M045193	KTSU	86681083	M060232	GRDL	
843006500	P206602	JNDR	854001	J540008	TRUX		M070069	BLNT	86300	M070068	DFLX		M060232	WRNR	
	P206602	TJAK	854002	P207299	TRUX		M070069	OMML	86350	M070069	DFLX	86682M	M100465	NLSN	
	P206602	CAT	854003	P207300	TRUX	8612947	P206403	BLNT	86371225	M070069	GRDL	86705M	M110077	NLSN	
844000	P206381	TRUX	854004	P224692	TRUX		P206403	BLNT	86400	M080024	DFLX	8671	J008671	AP	
844001	P216228	TRUX	854005	P224693	TRUX	8612965	P206410	BLNT	86400M	J640005	TRUX	86713M	M090544	NLSN	
844002	P207314	TRUX	854006	P224693	TRUX		P206410	CAT	86400	P224600	TRUX	86722M	M085267	NLSN	
844003	P207287	TRUX	854007	P224693	TRUX	8612966	M080024	BLNT	864001	P216202	TRUX	86724M	M110479	NLSN	
844004	P207317	TRUX	854008	P224693	TRUX		M080024	CAT	864671	P216205	TRUX	86725M	M100572	NLSN	
84437	X004536	LAWSON	854009	P224693	TRUX	8612986	P206406	BLNT	864672	P216205	TRUX	86739M	M090074	NLSN	
84438	X004537	LAWSON	854010	P206508	DFLX		P206406	CAT				8674	P216172	AP	
84439	X004476	LAWSON	85403160	M100464	GRDL	8612988	P206409	CAT							
84440	X004538	LAWSON	85403161	M090091	GRDL										

Cross Reference

(See first page of this section for Manufacturer's Code Listing)



CROSS REFERENCE

Mfgs. No.	Our No.	Mfg. Code	Mfgs. No.	Our No.	Mfg. Code	Mfgs. No.	Our No.	Mfg. Code	Mfgs. No.	Our No.	Mfg. Code	Mfgs. No.	Our No.	Mfg. Code
86740M.....	M090781.....	NLSN	87380522.....	P206304.....	TYLE	88500428.....	M120176.....	DFLX	89044C.....	P208359.....	NLSN	89111A.....	P207324.....	NLSN
8675.....	P206340.....	AP	874001.....	P209912.....	TRUX	88506.....	P206607.....	XAIR	89045A.....	P206382.....	NLSN	89113A.....	P207326.....	NLSN
8675034C91.....	M100049.....	CUCG	87400108.....	M090544.....	DFLX	8857720.....	X004478.....	DUHR	89045C.....	P206386.....	NLSN	89114A.....	P207328.....	NLSN
86752M.....	M120100.....	NLSN	87400108Q.....	M090544.....	DFLX	8867719.....	X004482.....	DUHR	89046A.....	J024750.....	NLSN	89115A.....	P207329.....	NLSN
86753M.....	M120100.....	NLSN	87400115.....	M120154.....	DFLX	8868.....	P226148.....	TRUX	89046C.....	J024751.....	NLSN	89115C.....	J190016.....	NLSN
8676.....	P206342.....	AP	87400115Q.....	M120154.....	DFLX	8869067.....	M120365.....	DUHR	89047A.....	P208374.....	NLSN	89116A.....	P206346.....	NLSN
86771M.....	M090823.....	NLSN	87400120.....	M090544.....	DFLX	8872.....	P226149.....	TRUX	89047C.....	P208375.....	NLSN	89117A.....	P207331.....	NLSN
8678.....	P206344.....	AP	87400127.....	M085171.....	DFLX	8875.....	P226129.....	TRUX	89048A.....	P206383.....	NLSN	89117C.....	J190019.....	NLSN
8680.....	P207339.....	AP	87400127Q.....	M085171.....	DFLX	8877.....	P226157.....	TRUX	89048C.....	P206387.....	NLSN	89118A.....	P206349.....	NLSN
8681.....	J008681.....	AP	87400131.....	M090544.....	DFLX	8878.....	P226156.....	TRUX	89049A.....	P208394.....	NLSN	89119A.....	P216175.....	NLSN
8683.....	P206394.....	AP	87400131Q.....	M090544.....	DFLX	8879.....	P226158.....	TRUX	89049C.....	P208395.....	NLSN	89123A.....	P207332.....	NLSN
8684.....	P206395.....	AP	87400144.....	M090362.....	DFLX	8880.....	P226129.....	AP	89050A.....	P208326.....	NLSN	89124A.....	J190009.....	NLSN
8685.....	P206396.....	AP	87400144Q.....	M090362.....	DFLX	8881.....	P226154.....	TRUX	89051A.....	P207293.....	NLSN	89125A.....	J190017.....	NLSN
86871209.....	M070069.....	GRDL	87400594.....	M090594.....	DFLX	8882.....	P226155.....	TRUX	89051C.....	P207318.....	NLSN	89126A.....	P207365.....	NLSN
86880066.....	M080024.....	GRDL	87400594Q.....	M090594.....	DFLX	8883.....	P226151.....	TRUX	89052A.....	P224633.....	NLSN	89127A.....	J190020.....	NLSN
86881083.....	M060232.....	WRNR	874005205.....	M100695.....	DFLX	8884.....	P226152.....	TRUX	89053A.....	P208350.....	NLSN	8913.....	P207397.....	AP
86881375.....	X004478.....	WRNR	874050514.....	M090781.....	DFLX	8885.....	P226152.....	AP	89053C.....	P216200.....	NLSN	89130A.....	P206393.....	NLSN
	X004478.....	GRDL	8740505140Q.....	M090781.....	DFLX	8886.....	P226144.....	TRUX	89054C.....	P207319.....	NLSN	89131A.....	P206394.....	NLSN
86883066.....	M080024.....	GRDL	874050514Q.....	M090781.....	DFLX	8887.....	P226144.....	AP	89055A.....	J024747.....	NLSN	89132A.....	P206395.....	NLSN
86883067.....	M100043.....	GRDL	87406803.....	P222018.....	EARN	8888.....	P226147.....	TRUX	89055C.....	J024757.....	NLSN	89133A.....	P206396.....	NLSN
	M100043.....	JLGI	87406903.....	M002135.....	CASE	8889.....	P226147.....	TRUX	89056A.....	P208366.....	NLSN	89140A.....	P207415.....	NLSN
8688D066.....	M080024.....	GRDL		M002135.....	ISERVI	8895.....	P226153.....	TRUX	89056C.....	J034746.....	NLSN	89141A.....	P206301.....	NLSN
86981541.....	M120365.....	GRDL		M002135.....	EARN	88H168193.....	M045193.....	DFLX	89057A.....	P207295.....	NLSN	89142A.....	P206927.....	NLSN
86983714.....	M100049.....	GRDL	87427885.....	M002134.....	CASE	88H200190.....	M060158.....	DFLX	89057C.....	P207320.....	NLSN	89143A.....	P206302.....	NLSN
87048600055.....	P213191.....	FXBL	87449404.....	M001503.....	CASE	88H250191.....	M065044.....	DFLX	89058A.....	J024747.....	TRUX	89143C.....	J014621.....	NLSN
	P213191.....	UCP	87455050514Q.....	M090781.....	DFLX	88H300102.....	M085090.....	DFLX		J024747.....	NLSN	89144A.....	P206303.....	NLSN
87052700003.....	X004484.....	FXBL	874608.....	P224635.....	TRUX	88H300192.....	M085090.....	DFLX	89058C.....	J024758.....	NLSN	89144C.....	J014622.....	NLSN
87052700004.....	X004482.....	FXBL	874609.....	P224638.....	TRUX	88H400148.....	M100146.....	DFLX	89059C.....	P216204.....	NLSN	89144A.....	J014622.....	NLSN
87052700005.....	X004480.....	FXBL	87500102.....	M090535.....	DFLX	89005A.....	P208328.....	NLSN	8906.....	P207411.....	TRUX	89145C.....	P207308.....	NLSN
87052700006.....	X004536.....	FXBL	87500102Q.....	M090535.....	DFLX	89006A.....	P206376.....	NLSN	89060A.....	P207296.....	NLSN	89146A.....	P206305.....	NLSN
870876C91.....	M100049.....	NAVI	87500130.....	M100465.....	DFLX	89007A.....	P206376.....	NLSN	89060C.....	P207321.....	NLSN		P207298.....	NLSN
8708876C91.....	M100049.....	NAVI	87500130Q.....	M100465.....	DFLX	89010A.....	P208336.....	NLSN	89072A.....	P206279.....	NLSN	89146C.....	P207309.....	NLSN
871834R91.....	M090544.....	NAVI	87500132.....	M090074.....	DFLX	89011A.....	P208336.....	NLSN	89073A.....	P206280.....	NLSN	89147A.....	P207559.....	NLSN
87185.....	P206343.....	CRQT	87500132Q.....	M090074.....	DFLX	89011A.....	P208324.....	NLSN	89073C.....	P206280.....	NLSN	89147C.....	P207559.....	NLSN
87200177.....	M060232.....	DFLX	87500145.....	M090072.....	DFLX	89012A.....	P206377.....	NLSN	89074A.....	J190023.....	NLSN	89150A.....	P206306.....	NLSN
87200177Q.....	M060232.....	DFLX	87500145Q.....	M090072.....	DFLX	89013A.....	J240012.....	NLSN	89075A.....	P206283.....	FTGD	89151A.....	P206308.....	NLSN
87250186.....	M065065.....	DFLX	87500674.....	M090595.....	DFLX	89015A.....	P206378.....	NLSN		J190027.....	NLSN	89152A.....	P206927.....	NLSN
87250186Q.....	M065065.....	DFLX	87500674Q.....	M090595.....	DFLX	89015A.....	P206378.....	NLSN	89077A.....	P206281.....	NLSN	89153A.....	P206309.....	NLSN
	M065071.....	DFLX	875390.....	M100464.....	IVECO	89015C.....	P206388.....	NLSN	89081A.....	P207347.....	NLSN	89154A.....	P206310.....	NLSN
87300004.....	M060005.....	LKWD	875480.....	P206543.....	ECS	89016A.....	P224589.....	NLSN	89082A.....	P207349.....	NLSN	89155A.....	P208386.....	NLSN
87300018.....	M080018.....	DFLX	87674684.....	P224515.....	RYKE	89016C.....	P224590.....	NLSN	89083A.....	P207351.....	NLSN	89155C.....	P206384.....	NLSN
87300018Q.....	M080018.....	DFLX	87674852.....	M002123.....	CASE	89018A.....	P206379.....	NLSN	89084A.....	P207353.....	NLSN	89156A.....	P208392.....	NLSN
87301605.....	M002120.....	CASE		M002123.....	NH	89018C.....	P206389.....	NLSN	89090A.....	P207362.....	NLSN	89156C.....	P206385.....	NLSN
	M002120.....	NH	8771.....	P206328.....	NH	89019A.....	P208393.....	NLSN	89091A.....	P206397.....	NLSN	89157A.....	P207419.....	NLSN
	M002120.....	ISERVI	8776.....	P216175.....	NH	89019C.....	P206391.....	NLSN	89092A.....	P207363.....	NLSN	89160A.....	P206372.....	NLSN
87309100001.....	M090595.....	FXBL	8777.....	P206365.....	NH	89020A.....	P208324.....	NLSN	89093A.....	P206398.....	NLSN	89161A.....	P206373.....	NLSN
87314920.....	M001503.....	NH	87NPT350174.....	M070008.....	DFLX	89021A.....	P207285.....	NLSN	89094A.....	P207364.....	NLSN	89162A.....	P206374.....	NLSN
	M001503.....	CASE	880L1.....	M090074.....	DREO	89021C.....	P207314.....	NLSN	89095A.....	P206399.....	NLSN	89162A.....	P206374.....	NLSN
87319252.....	M002119.....	KBCO		M090074.....	WGMG	89022A.....	J024735.....	NLSN	89096A.....	P207365.....	NLSN	89163A.....	P206375.....	NLSN
	M002119.....	CASE		M090074.....	DLEQ	89023A.....	P208348.....	NLSN	89097A.....	P206400.....	NLSN	89164A.....	P206367.....	NLSN
8733.....	M065071.....	LKWD	8814.....	P206333.....	AP	89024A.....	P207286.....	NLSN	89098A.....	P207333.....	NLSN	89165A.....	P206368.....	NLSN
8734.....	M060005.....	LKWD	8815.....	P206334.....	AP	89025A.....	J024737.....	NLSN	89099A.....	P207335.....	NLSN	89166A.....	P206369.....	NLSN
87350028.....	M070028.....	DFLX	8816.....	P206335.....	AP	89025C.....	P224627.....	NLSN	89101A.....	P206340.....	NLSN	89167A.....	P206370.....	NLSN
87350028Q.....	M070028.....	DFLX	8821116.....	P206605.....	MCII	89026A.....	P208364.....	NLSN	89101C.....	P206340.....	NLSN	89168A.....	P206319.....	NLSN
87350113.....	M090146.....	DFLX		P206605.....	L3COM	89026C.....	P224628.....	NLSN	89102A.....	P206341.....	NLSN	89169A.....	P207401.....	NLSN
87350113Q.....	M090146.....	DFLX	8821116REVD.....	P206605.....	L3COM	89027A.....	P207287.....	NLSN	89103A.....	P206342.....	NLSN	89170A.....	P206320.....	NLSN
87350345.....	M090146.....	DFLX	8821974.....	P206409.....	LIBB	89028A.....	J024739.....	NLSN	89103C.....	P206342.....	NLSN	89171A.....	P206321.....	NLSN
87352.....	X004536.....	CNLC		P206409.....	MCII	89028C.....	J240024.....	NLSN	89104A.....	P206343.....	NLSN	89172A.....	P206322.....	NLSN
87352X.....	X004536.....	CNLC	88300.....	P206612.....	XAIR	89029A.....	P208380.....	NLSN	89104C.....	P206343.....	NLSN	89173A.....	P206323.....	NLSN
87353.....	X004537.....	CNLC	88300218.....	M085207.....	DFLX	89029C.....	J340023.....	NLSN	89104C.....	P206343.....	NLSN	8918.....	P206526.....	NH
87353X.....	X004537.....	CNLC	88306.....	P206604.....	XAIR	89030A.....	P207292.....	NLSN	89105A.....	P206344.....	NLSN	89180A.....	P207389.....	NLSN
87354.....	X004476.....	CNLC	88316.....	J009612.....	XAIR	89030C.....	P207317.....	NLSN		P206344.....	FTGD	89181A.....	P206324.....	NLSN
87354X.....	X004476.....	CNLC	88350.....	P206613.....	XAIR	89031A.....	P207289.....	NLSN	89105C.....	P207345.....	NLSN	89182A.....	P206324.....	NLSN
87355.....	X004538.....	CNLC	88356.....	P206605.....	XAIR	89031A.....	P207289.....	NLSN	89106A.....	P206345.....	FTGD	89183A.....	P207386.....	NLSN
87355X.....	X004538.....	CNLC	884000.....	P209913.....	TRUX	89031C.....	P207300.....	NLSN		P206345.....	NLSN	89184A.....	P206325.....	NLSN
87356.....	X004478.....	CNLC	88400133.....	M100049.....	DFLX	89035A.....	P208330.....	NLSN	89106C.....	P206353.....	NLSN	89185A.....	P206326.....	NLSN
87356X.....	X004478.....	CNLC	88406.....	P206606.....	XAIR	89035C.....	J240016.....	NLSN	89107A.....	P206347.....	FTGD	89186A.....	P206327.....	NLSN
87357.....	X004480.....	CNLC	884250191.....	M065044.....	DFLX	89037A.....	P206380.....	NLSN		P206347.....	NLSN	89187A.....	P206328.....	NLSN
8735														

(See first page of this section for Manufacturer's Code Listing)

Mfgs. No.	Our No.	Mfg. Code	Mfgs. No.	Our No.	Mfg. Code	Mfgs. No.	Our No.	Mfg. Code	Mfgs. No.	Our No.	Mfg. Code	Mfgs. No.	Our No.	Mfg. Code	
89217C	P207299	NLSN	89425A	P270534	NLSN	89529W	X004539	NLSN	89626K	P226153	NLSN	89748A	P206542	NLSN	
89218A	P207283	NLSN	89425C	P270534	NLSN	89529W20	X004539	FTGD	8963	P206321	TRUX	89749C	X005207	NLSN	
89220A	P216197	NLSN	89427A	P270535	NLSN	8953	P206313	AP	8965	P206321	AP	8975	P206367	AP	
89222A	P208388	NLSN	89430A	P270536	NLSN	89533K	P206313	TRUX	8964	P206322	AP	8976	P206368	AP	
89222C	P208389	NLSN	89430C	P271507	NLSN	89534K	J009614	NLSN	89641K	P206322	TRUX	89761K	P206510	NLSN	
89223A	P216206	NLSN	89435A	P270538	NLSN	89534K	J009614	NLSN	89642K	P226149	NLSN	89762K	P206511	NLSN	
89226A	P207290	NLSN	89435C	P271508	NLSN	89535K	P206515	NLSN	89643K	P226140	NLSN	89763K	P206512	NLSN	
89226C	P207301	NLSN	89440A	P270539	NLSN	89537K	P206516	NLSN	89644K	P226141	NLSN	89766K	P206511	NLSN	
89227C	P207302	NLSN	89440C	P270837	NLSN	89538K	P206520	NLSN	89645K	P226142	NLSN	89770K	P206508	NLSN	
89231A	P216174	NLSN	89440E	P270539	NLSN	89539K	P206517	NLSN	89646K	P226143	NLSN	89771K	P206509	NLSN	
89232A	P216172	NLSN	89445A	P270541	NLSN	8954	P206518	NLSN	8965	P226150	NLSN	89775K	P205834	NLSN	
89233A	P207325	NLSN	89450A	P270541	NLSN	8954	P207386	AP	8965	P206323	AP	89775K20	P206641	NLSN	
89234A	J190013	NLSN	89450C	P270838	NLSN	8954	P207386	TRUX	89660K	P206323	TRUX	8978	P206641	FTGD	
89235A	J190014	NLSN	89450E	P270541	NLSN	89540K	P206519	NLSN	89661K	P224684	NLSN	8978A	P206375	TRUX	
89236A	P207366	NLSN	89455A	P270542	NLSN	89541K	P206403	NLSN	89662K	P207367	NLSN	89780A	P206282	NLSN	
	P207361	NLSN	89460A	P270543	NLSN	89542K	P206404	NLSN	89663K	P206849	NLSN	89780C	P206285	NLSN	
89242A	P207350	NLSN	89460C	P271511	NLSN	89543K	P206405	NLSN	89664K	P207368	NLSN	89781A	J190025	NLSN	
89243A	P207350	NLSN	8947	P207382	TRUX	89544K	P206406	NLSN	89665K	P206850	NLSN	89781C	P206286	NLSN	
89243C	J014621	NLSN	89487	M170101	DLTC	89545K	P206407	NLSN	89666K	P206851	NLSN	89782A	P207353	NLSN	
89244A	P206366	NLSN	89500117	M120365	DFLX	89546K	P206408	NLSN	89667K	P207369	NLSN	89783A	P207354	NLSN	
89245A	P206362	NLSN	89500147	M120225	DFLX	89547K	P206409	NLSN	89670K	P206331	NLSN	89784A	P207339	NLSN	
89246A	P206363	NLSN	89500K	J009612	NLSN	89548K	P206409	NLSN	89671K	P206333	NLSN	89784C	J009547	NLSN	
89247A	P206364	NLSN	89501K	P206605	NLSN	89548K	P206410	NLSN	89672K	P206334	NLSN	8979	P207414	AP	
89248A	P206365	NLSN	89502K	P206605	NLSN	89549C	J009487	NLSN	89673K	P206335	NLSN		P207414	TRUX	
89249A	P207411	NLSN	89503K	P206607	NLSN	89549K	P206411	NLSN	89674K	P206336	NLSN	8982	P226132	AP	
89250137	M065065	DFLX	89505K	P206604	NLSN	8955	P206314	TRUX	89676K	P206338	NLSN		P226132	TRUX	
89250137Q	M065065	DFLX	89506K	P206605	NLSN	8955	P206314	TRUX	89678K	P206337	NLSN	8983	P226133	TRUX	
89250A	P206366	NLSN	89507K	P206606	NLSN	89550K	P206314	AP	89681K	P226140	NLSN		P226133	AP	
89251A	P207413	NLSN	89508K	J009611	NLSN	89551K	P207667	NLSN	89683K	P206333	NLSN	8984	P226148	TRUX	
89252A	P207414	NLSN	89510K	P210110	NLSN	89551K	P206521	NLSN	89685K	P206334	NLSN	8985	P226149	TRUX	
89253A	J190042	NLSN	89511K	P206604	NLSN	89556K	P206600	NLSN	89686K	P206335	NLSN	89850218	P270540	CASE	
89254A	J190044	NLSN	89512K	J009613	TRUX	89557K	P206601	NLSN	89687K	P206336	NLSN	8986	P226140	TRUX	
89255A	J190045	NLSN		J009613	NLSN	89558K	P206602	NLSN	89688K	P206337	NLSN	8987	P226141	TRUX	
89256A	J009649	NLSN	89513K	P206606	NLSN	89559K	P206603	NLSN	8969	P207394	AP	8988	P226142	TRUX	
89257A	P206362	NLSN	89514K	P213191	NLSN	8956	P206315	AP	8969	P207394	TRUX	89881A	J009648	NLSN	
89258A	P206363	NLSN	89518K	P207784	NLSN	89560K	P206315	TRUX	89698K	P206338	NLSN	89883A	J009650	NLSN	
89259A	P206364	NLSN	89519K	P206507	NLSN	89566K	P207596	NLSN	8970	P206362	TRUX	8989	P226143	TRUX	
8925K	J000219	NLSN	8952	P207385	AP	89567K	P206608	NLSN	8971	P206362	AP	89897A	J028528	NLSN	
89260A	P206365	NLSN	89520K	P222018	NLSN	89568K	P206609	NLSN	8971	P206363	TRUX	89899A	P224581	NLSN	
89261A	P207405	NLSN	89521K	X004536	NLSN	89569K	P206610	NLSN	8971	P206363	AP	8990	P226150	TRUX	
89263A	P206371	NLSN	89521W	X004536	NLSN	8957	P206611	NLSN	89712K	P226129	NLSN	8991	P206369	TRUX	
89266A	P207408	NLSN	89521W20	X004536	FTGD	89570K	P206316	TRUX	89713K	P226154	NLSN	89910C	P224607	NLSN	
89268A	P207382	NLSN	89522K	J000212	NLSN	89570K	P206316	TRUX	89714K	P226155	NLSN	89915C	P208385	NLSN	
89270A	P207385	NLSN	89522W	X004537	FTGD	89571K	P207598	NLSN	89715K	P226157	NLSN	89916A	J640001	NLSN	
89271A	P206313	NLSN	89522W20	X004537	FTGD	89573K	J009618	NLSN	8972	P206364	AP	89921C	P224696	NLSN	
89273A	P207386	NLSN	89523B	J000211	NLSN	8958	P222018	NLSN	8972	P206364	TRUX	89922C	P224703	NLSN	
89274A	P206314	NLSN	89523K	X004478	GRMC	8959	P206317	TRUX	89721K	P206364	TRUX	89923A	J008681	NLSN	
89275A	P206315	NLSN		X004478	NLSN	8959	P206324	AP	89722	P226132	NLSN	89923C	P224671	NLSN	
89276A	P206316	NLSN	89523W	X004476	NLSN	8960	P206319	AP	89722K	P226133	NLSN	89924A	J190003	NLSN	
89277A	P206317	NLSN		X004476	NLSN		P206319	TRUX	89723K	P226156	NLSN	89924C	J190004	NLSN	
89278A	P206318	NLSN	89523W20	X004476	FTGD	89606K	J024754	NLSN	89724K	P226158	NLSN	89925A	P207330	NLSN	
89279A	J008942	NLSN	89524B	X004538	FTGD	89607K	J024835	NLSN	89726K	P226158	NLSN	89926A	P207332	NLSN	
89283A	P207402	NLSN	89524K	P226146	NLSN	89608K	J034743	NLSN	89727K	J240006	NLSN	89926K	P207365	NLSN	
89293C	J640005	NLSN		X004538	NLSN	89609K	J024755	NLSN	89728K	P206554	NLSN	89940A	P206297	NLSN	
89295C	P209913	NLSN	89524W	X004538	FTGD	8961	J024836	NLSN	89729K	J024836	NLSN	89940C	P206297	NLSN	
89296A	P224600	NLSN		X004538	FTGD		P207401	TRUX		J034673	NLSN	89941A	J092679	NLSN	
89296C	P224600	NLSN	89525B	J000214	NLSN	89610K	P207401	AP	8973	P206365	AP	89950A	P206298	NLSN	
89298C	P209912	NLSN	89525K	X004478	NLSN	89611K	J024837	NLSN		P206365	TRUX	89950C	P206298	NLSN	
89300139	M085023	DFLX	89525W	X004478	NLSN	89612K	J034744	NLSN	89730K	J240007	NLSN	89951A	J092689	NLSN	
89313K	J024755	NLSN	89525W20	X004478	FTGD	89612K	J240003	NLSN	89731K	P206555	NLSN	89955K	P207619	NLSN	
89350106	M090158	DFLX	89526K	X004480	NLSN	89613K	P206552	NLSN	89732K	P206555	NLSN	89957K	P207568	NLSN	
89354051	M090520	DFLX	89526W	X004480	NLSN	89614K	J240004	NLSN	89733K	J024838	NLSN	89958K	P207581	NLSN	
89354055	M090520	DFLX	89526W20	X004480	FTGD	89615K	J240004	NLSN		J024838	NLSN	89959K	P207567	NLSN	
89400125	M120100	DFLX	89527B	J000216	NLSN	89616K	J240005	NLSN	89736K	P206544	NLSN	89960K	P207567	NLSN	
89400153	M090280	DFLX	89527K	X004482	NLSN	89617K	P206553	NLSN	8974	P207408	TRUX	89961K	P207566	NLSN	
8941	P207389	TRUX	89527W	X004482	NLSN	89618K	J024850	NLSN		P207408	AP	89962K	J009391	NLSN	
	P207389	AP	89527W20	X004482	FTGD	8962	P206320	AP	89740K	P206546	NLSN	89964K	P206614	NLSN	
89417A	P270531	NLSN	89528B	J000217	NLSN		P206320	TRUX	89742K	P206547	NLSN	89965K	P207567	NLSN	
8942	J008942	TRUX	89528K	X004484	NLSN	89620K	J226151	NLSN	89744C	P206543	NLSN	89966K	J009393	NLSN	
	J008942	AP	89528W	X004484	NLSN	89621K	P226152	NLSN	89745C	J009429	NLSN	89967K	P206615	NLSN	
89420A	P270532	NLSN	89528W20	X004484	FTGD	89622K	P226144	NLSN	89747C	J009429	NLSN	89969K	P207582	NLSN	
89422A	P270533	NLSN		X004484	FTGD	89623K	P226145	NLSN		P206542	NLSN	89971K	P207584	NLSN	
			89529K	X004539	NLSN	89624K	P226146	NLSN		P206540	NLSN	89973K	P206616	NLSN	
						89625K	P226147	NLSN							

Cross Reference

(See first page of this section for Manufacturer's Code Listing)



CROSS REFERENCE

Mfgs. No.	Our No.	Mfg. Code	Mfgs. No.	Our No.	Mfg. Code	Mfgs. No.	Our No.	Mfg. Code	Mfgs. No.	Our No.	Mfg. Code	Mfgs. No.	Our No.	Mfg. Code
89974K	P206617	NLSN	8NG28092	P206333	AA	90076A	P206523	NLSN	90444C	P224641	NLSN	90873A	J000200	NLSN
89985C	P216202	NLSN	8NG281072	P271511	AA	90077A	P206524	NLSN	90446A	P224711	NLSN	90874A	J000201	NLSN
89986C	P224635	NLSN	8NG28118	P206407	AST	90079A	P206525	NLSN	9045722	X007784	WSTI	90875A	J000202	NLSN
89988A	P224709	NLSN		P206407	AA	90080A	P206526	NLSN	9045723	X007785	WSTI	90876A	J000208	NLSN
89988C	P216205	NLSN		P206407	ASTEC	90092A	J000231	NLSN		X007785	FRTL	90877A	J000203	NLSN
89989C	P224638	NLSN	8NG28119	P206409	ASTEC	9013928	M120108	GM	90459A	P207338	NLSN	90878A	J000209	NLSN
89990C	P209910	NLSN		P206409	AST		M120108	TREX	90460A	P270538	DYPC	90889A	J190009	NLSN
89991C	P224698	NLSN		P206409	AA	9014271	M090544	WGMC	90460A	P207340	NLSN	90902K	P224481	NLSN
89993C	P216227	NLSN	8NG3100024	M101171	AA	901866	P206347	U C	90463A	J190002	NLSN	90903K	P224479	NLSN
89994C	P216228	NLSN	8NG3100025	M101171	AA	901867	P207289	U C	90464K	X004962	NLSN	90909A	P206304	NLSN
89996C	J009429	NLSN	8NG3100026	J009648	AA	901868	P206347	U C	90465A	J009560	NLSN	90909C	J014623	NLSN
8A4282	M090544	FMC	8NG3100125	P270539	AA	902353	M090210	U C	90466	X004482	MCHC	90910	M090594	RKRM
8A5098	M085023	CRAN	8NG48009	J024755	AA	90285	P206334	HRCN	90468K	J009514	NLSN	90910A	P224617	NLSN
8A5566A	M080024	FMC	8NG48010	P226150	AA	90298	P206338	TYLE	90469K	J009516	NLSN	90910C	P224618	NLSN
8A5810	M120197	FMC	8NG60001105	P206556	AA	90300	P224684	DFLX	90470K	J009518	NLSN	90913A	P206311	NLSN
8A6256	M100464	FMC	8NG60001106	X004539	AA	903059	M085056	U C	90510	P206299	XAIR	90915	M090146	RKRM
	M100464	LKBT	8NG80007	P206543	AA	90354A	X007833	NLSN	905154	X004482	U C	90915K	J000222	NLSN
8A6256A	M100464	FMC	8NG800071	P206509	AA		J009604	NLSN	90520	P206300	XAIR	90916	M090544	RKRM
8C1110	P207596	CAT	8XD448	M090544	RKRM	90355A	X007834	NLSN	90521K	P226151	NLSN	90916K	J000221	NLSN
8C8123	M085078	RYGO					J009605	NLSN	90527K	J009612	NLSN	90917	M090074	RKRM
	M085078	BABR	9				X006204	NLSN	90528K	J009611	NLSN	90929K	J000220	NLSN
	M085078	CAT	900040K	J000224	NLSN	90356A	J009606	NLSN	90529K	J009613	NLSN	90945	M090781	RKRM
8CL17228	P206517	AA	900041K	J000227	NLSN		X007824	NLSN	90532A	P205979	NLSN	90958A	P207330	NLSN
8EG1000403	M101167	AA	900042K	J000228	NLSN		X006203	NLSN	90533A	P206299	NLSN	90975A	J018110	NLSN
8HB463	P206321	OKSH	900043K	J000230	NLSN	90357A	J190054	NLSN	90538A	P205976	NLSN	90979A	J038612	NLSN
8I5743	X007829	TIM	900044K	J000232	NLSN	90358A	J009607	NLSN	90539A	P206300	NLSN	90980A	J038611	NLSN
	X004476	BROW	900045K	J000233	NLSN		X007805	NLSN	90546K	P222740	NLSN	90993	P216174	HRCN
	X004476	CAT	900046A	J008671	NLSN		X006202	NLSN	90547K	P222741	NLSN	90HL70R60	P215307	CASE
8I5746	X004482	BROW	900048A	P206339	NLSN		X006202	FTGD	90554K	P222742	NLSN	90UH1	J006518	ACFT
	X004482	CAT	900049A	P207335	NLSN	90359A	J190055	NLSN	90560A	J190046	NLSN	910033	P207354	U C
	X004482	TIM	900050A	P216172	NLSN	90360A	P206319	U C	90561A	J190041	NLSN	9103074	M045193	MOB
8LT400	M090362	RKRM	900052A	P206340	NLSN	90360A	J190056	NLSN	90562A	P206344	NLSN		M045193	WLDN
8NG1000501	M085056	AA	900053A	P224669	NLSN	90361A	J190057	NLSN	90569A	P206615	NLSN	910807	P200282	U C
8NG1000503	P206324	AA	900055A	J008681	NLSN	90362A	J190058	NLSN	905722	M065034	U C	91083101	M085056	GRDL
8NG1000504	X004476	AA	900056A	P206344	NLSN		X007829	NLSN	90589C	P224609	NLSN	91083250	M065034	MJPP
8NG100081	P206519	AA	900057A	P207341	NLSN	90363A	J190059	NLSN	90593C	P224699	NLSN		M065034	GRDL
8NG1001506	M091050	AA	900058A	P207327	NLSN	90364A	J190060	NLSN	90595C	P224605	NLSN		M065034	JLGI
8NG1001507	P270538	AA	900059A	P206346	NLSN		X007830	NLSN	90597C	P224707	NLSN	91094960	P226140	KTSU
8NG1001508	P206342	AA	900061A	P207332	NLSN	90365A	X007831	NLSN	90600413	M100146	IR		P226140	DMAG
8NG1001602	P207322	AA	900062A	P207365	NLSN		J190061	NLSN	90600424	M100048	IR		P226140	MH
8NG1001604	P270532	AA	900063A	P207366	NLSN	90366A	J009623	NLSN		M100048	IRT	91095	P206399	HRCN
8NG1001608	M060251	AA	900064A	P206282	NLSN		X007784	NLSN	90600434	M090544	IR	91096	P207353	HRCN
8NG1002302	M091048	AA	900065A	P206283	NLSN	90367A	J190062	NLSN		M090544	IRT	91108	P207351	HRCN
8NG1002303	P226145	AA	900066C	P206283	NLSN	9036810011	M120235	VMER	90600435	X005207	IRT	91109	P207322	HRCN
8NG18000	M085206	AA	900066A	P207359	NLSN	903682001	P206347	VMER		X005207	IR	91126	P207366	HRCN
8NG18001	P207362	AA	900067A	P207359	NLSN	9036820011	P206347	VMER	90604C	P224707	NLSN	91126937	M100213	GM
8NG18002	P207361	AA	900068A	P207352	NLSN	90368A	J009624	NLSN	90615K	J000127	NLSN	911349	M045237	U C
8NG18003	P207366	ASTEC	900069A	P207354	NLSN		X007785	NLSN	90624A	P206299	NLSN	911613	M170101	U C
	P207366	AA	900070A	P207354	NLSN	90369A	X009076	NLSN	9063047	M085293	TREX	911614	X004539	U C
	P207366	AST	900072A	J009631	NLSN		J190063	NLSN	90631	J009631	TRUX	911615	P270543	U C
8NG20011105	P206544	AA	900073A	J009632	NLSN	90372A	P222744	NLSN	90691505	M100016	NAT	911616	P207667	U C
8NG20011107	X005207	AA	900074A	J009633	NLSN	90373A	P222745	NLSN		M100016	IRT	911617	P206559	U C
8NG20011112	P206362	AA	900076A	J009635	NLSN	90374A	P222746	NLSN	906922	M090301	U C	911618	P206338	U C
8NG20011113	P206397	AA	900077A	J009636	NLSN	90375A	P222747	NLSN	90786	J190003	HRCN	911619	P207341	U C
8NG20011114	P206309	AA	900078A	J009637	NLSN	90376A	P222748	NLSN	9079368	M170101	TREX	911624	P206851	U C
8NG2002002	P224628	AA	900080A	J009639	NLSN	90377A	P222749	NLSN	907996	P207566	U C	91163035	M085056	JLGI
8NG28016	P206340	AA	900081A	J009640	NLSN	90378A	P222750	NLSN	907997	P206607	U C		M085056	GRDL
8NG28023	X004484	AA	900082A	J009641	NLSN	90379A	P222751	NLSN	90822A	P207364	NLSN	91163035CP	M085056	JLGI
8NG28027	P206602	AA	900085A	J009644	NLSN	90380A	P222752	NLSN	908319T1	X007784	CASE	91173	P206400	HRCN
8NG28030	X004482	AA	900086A	J009645	NLSN	90382A	P222753	NLSN	908320T1	X007785	CASE	911753	M122300	IR
8NG2803035	X004480	AA	900089C	P224636	NLSN	90383A	P222754	NLSN	90847A	P206344	NLSN		M170101	CABT
8NG28042	P206410	AST	90009	M085008	RKRM	90384A	P222755	NLSN	90847C	P207345	NLSN	911778	M090009	CABT
	P206410	ASTEC	900091A	P224582	NLSN	90385A	P222756	NLSN	90857K	P224492	NLSN		M090009	IR
	P206410	AA	900098A	J190002	NLSN	90386A	P222757	NLSN	90859A	P207339	NLSN		M090009	IRT
8NG28044	P206411	AA	900109004004	X007785	MRMN	90387A	P222758	NLSN	90859C	J009547	NLSN	911782	M070050	CABT
8NG28080	P207667	AA	900109009003	X007784	MRMN	90388A	P222759	NLSN	90866A	J000227	NLSN	911784	M070008	IR
8NG28081	P207341	AA	900109009004	X007785	MRMN	90410	P205979	XAIR	90867A	J000230	NLSN		M070008	IRT
8NG28090	P206403	ASTEC	900190A	J009479	NLSN	90420	P205976	XAIR	90868A	J000232	NLSN		M070008	CABT
	P206403	AST	900199006	P206337	FMNT	90438C	J540008	NLSN	90869A	J000204	NLSN	911948	P207349	U C
	P206403	AA	900201	P270539	DYPC	90439C	P224608	NLSN	90870A	J000205	NLSN	911949	P207351	U C
8NG280908	P206850	AA	900424	M085407	MRBR	90440C	P224706	NLSN	90871A	J000206	NLSN	911950	P207324	U C
8NG28091	P206405	AA	900426	M085408	MRBR	90441C	P224611	NLSN	90872A	J000207	NLSN	911951	P207362	U C
						90444A	P224710	NLSN				911952	P207326	U C

(See first page of this section for Manufacturer's Code Listing)

Mfgs. No.	Our No.	Mfg. Code	Mfgs. No.	Our No.	Mfg. Code	Mfgs. No.	Our No.	Mfg. Code	Mfgs. No.	Our No.	Mfg. Code	Mfgs. No.	Our No.	Mfg. Code
91203058	M045237	GRDL	92679	J092679	TRUX	9336	P207402	TRUX		P270541	TRUX		X004536	TREX
91203087	P206306	GRDL		J092679	AP		P207402	AP	9378	P270535	TRUX	9450	P270540	HDMI
91233003	M065071	GRDL	92689	J092689	TRUX	93368	P206321	CRMY		P270535	AP		P270540	ECS
912361	P206370	U C		J092689	AP	9337	P206397	AP		P270535	DFLX	94507	M120365	RKRM
91267	P206346	HRCN	92695	P206297	TRUX	9338	P206398	AP	9379	P270535	AP	9451	P206510	TRUX
	P206346	GRST	92696	P206298	TRUX	9339	P206399	AP	9381	X004536	TRUX		P206510	AP
91279	J009649	HRCN	92697	P206298	TRUX	9340	P206400	AP		X004536	GOE	9452	P206511	TRUX
	J009649	GRST	927002	P206851	TRUX	934001	P205976	DFLX		X004536	AP		P206511	AP
91301	M065030	GNRC	92701012391	M090158	GRVE	9341	P205979	TRUX	9382	X004537	AP	9453	P206512	TRUX
9141094	P206546	VLVO	9270102391	M090158	GRVE	9342	P206299	GOE		X004537	TRUX		P206512	AP
91410947	P206546	VLVO	9275	P270535	HDMI		P206299	TRUX		X004537	GOE	945530011	P270541	VMER
91413140	P206371	JLGI	92794437	H001035	IR	934270	X004484	IVECO	9383	X004476	AP	9456	P206508	AP
9150	P270530	ECS	928002	P207369	TRUX	934285	X004482	IVECO		X004476	TRUX		P206508	TRUX
9155711	P206546	VLVO		P207369	GOE	934286	X004480	IVECO		X004476	GOE	94569	P206602	CMI
91557116	P206546	VLVO	9283113008	M122300	EIMC	9343	P205976	TRUX	9384	X004478	AP	9457	P206509	GOE
916833	X004482	U C	9284749	M100146	GRVE	9344	P206300	TRUX		X004478	TRUX		P206509	GOE
916834	P206346	U C	929002A	P206331	NLSN	9345	P206617	AP		X004478	GOE		P206509	TRUX
916864	P206346	U C	929004A	P206333	NLSN	9346	P206616	AP	9385	X004480	TRUX	9458	P206543	AP
9186262	P206546	VLVO	929005A	P206333	NLSN	934766	X005207	IVECO		X004480	AP	945946	X004484	TREX
9186269	J000220	GDL	929006A	P206334	NLSN	9350	P270538	HDMI		X004480	GOE		X004484	OK
91910	M090594	RKRM	929007A	P206336	NLSN		P270538	ECS	9386	X004482	TRUX	946100325	P206280	RSCO
919206	P208394	U C	929014K	P206333	NLSN		P207784	AP		X004482	AP		P206280	BRLEE
9200	P270532	HDMI	929015K	P206334	NLSN		P207784	TRUX	9386890	X004484	KRON	9470	P207619	AP
	P270532	XAIR	929022K	P206335	NLSN	935001	P206300	DFLX	9386900	P208374	KRON		P207619	GOE
920007402	M065044	CASE	929023K	P206336	NLSN	9350CP	P271508	HDMI	9386910	J190003	KRON	9472	P207582	AP
920018271	P206409	CASE	929024A	J000127	NLSN	9350Z	P270538	HDMI	9386920	M100213	KRON	9473	P207581	TRUX
920018376	P206407	CASE	929025A	P206334	NLSN	9354	P206515	TRUX	9387	X004484	AP		P207581	AP
920019350	P206408	CASE	929026A	P206335	NLSN	9355	P206516	TRUX		X004484	GOE	9474	P206614	AP
920019377	P206406	CASE	929027A	P206336	NLSN	935598	P270838	IVECO		X004484	TRUX		P206614	GOE
920019473	M001702	NH	929030A	P206335	NLSN	9356	P206517	TRUX	9388	X004539	AP		P206614	TRUX
920019547	M001502	NH	929034S	P224685	NLSN	9357	P206518	TRUX		X004539	GOE	9474Q	P206614	AP
920019550	M001756	NH	929035S	P224686	NLSN		P206518	AP		X004539	TRUX	9475	P207567	AP
920034AA	J009604	SKYJ	929036S	P224687	NLSN	9358	P206519	TRUX	9389	X004538	GOE		P207567	TRUX
9202940451	M100146	EIMC	9300	P270536	XAIR		P206519	AP		X004538	AP	9476	P207620	TRUX
920507	P207282	U C	9300CP	P271507	HDMI	9359	P206521	TRUX		X004538	TRUX		P207620	AP
9206602	P206602	NEWFLY	9303	P207335	AP		P206521	TRUX	9390	P206612	TRUX	9478	P206615	TRUX
9206960019	P270540	KLMA	9304	P206341	AP	935952	M090091	IVECO	9391	J009391	TRUX		P206615	AP
921097	P206409	DYPC	9305	P206343	AP	9360	P206520	TRUX		J009391	TRUX	9479	J009479	TRUX
921098	P206604	DYPC	9306	P206345	AP	93610450	X004478	DMAG	9392	P207568	TRUX		J009479	AP
9214205	M100016	TREX	9308	P206348	AP		X004478	KTSU		P207568	TRUX	9486	J009486	TRUX
	M100016	VME	9308052	P226146	ELGN		X004478	MH	9393	J009393	TRUX		J009486	AP
9218031	M090095	TREX	9308053	X004482	ELGN	93610500	P206409	MH		J009393	AP	9487	J009487	TRUX
	M090095	VME	9309	P206349	AP		P206409	KTSU	9394	P207566	TRUX		J009487	TRUX
	M090095	ECLD	9310	P206350	AP		P206409	DMAG		P207566	AP	9490	P206608	AP
921989	M045237	DYPC	9312	P206279	AP	936203	M120189	IVECO	9395	P206604	TRUX	9491	P206609	TRUX
921997	P206301	DYPC	9313	P206280	AP	9363	P206523	TRUX		P206604	AP		P206609	AP
92234	P206321	HRCN	931359AA	M060055	SKYJ		P206523	AP	9396	P206605	TRUX	9492	P206610	TRUX
9225	P270533	HDMI	9314	P206281	AP	9364	P206524	TRUX		P206605	TRUX		P206610	AP
	P270533	XAIR	9314C094115	X004480	ENTW		P206524	TRUX	9397	P213191	AP	94927	P207394	CMI
922701	P270536	U C	9314C094120	P206408	ENTW	9365	P206525	AP		P213191	TRUX	9493	P206611	AP
9228310001	X004537	KLMA	9315	P206282	AP		P206525	TRUX	9398	P206604	AP		P206611	TRUX
9228310002	X004538	KLMA	9317	P206283	AP	9366	P206526	TRUX		P206604	TRUX	9495	P207598	TRUX
9228310004	X004482	KLMA	9318	P207350	AP		P206526	AP	9399	P206606	AP		P207598	AP
9228310005	X004480	KLMA	931900	P226142	SAME		P206526	CSND		P206606	TRUX	9500	P270541	XAIR
923002	P224684	TRUX	931SA0393	M120100	CLRK	93671042	M090210	GRDL		P270539	XAIR		P270541	HDMI
924002	P207367	TRUX	931SA185	M120100	CLRK	9368	P270542	AP		P270539	GRMC	9500900008	M120365	IR
924465	P207331	U C	931SB0393	M090072	CLRK	9369	P270543	AP		P270539	ECS	9500CP	P270838	HDMI
924466	P207365	U C	932367	M080024	IVECO		P270543	TRUX		P270539	HDMI	9500Z	P270541	HDMI
9250	P270534	XAIR	9329	P207363	AP	9370	P270533	TRUX	94006	M100049	RKRM	9501	P206600	TRUX
	P270534	HDMI	9330	P207361	AP		P270533	TRUX	94007	M090538	RKRM		P206600	AP
925002	P206849	TRUX	9330C09102101	P206410	ENTW	9371	P270532	TRUX	9400CP	P270837	HDMI	9502	P206601	AP
925262AA	M085056	SKYJ	9331	P206328	AP		P270532	TRUX	9400Z	P270539	HDMI	950250016	M045237	EIMC
925502	P207368	GOE	9332	P206328	TRUX	9372	P270534	TRUX	9406	P206353	AP	9503	P206602	TRUX
	P207368	TRUX		P206327	TRUX		P270534	AP	9408	P206354	AP		P206602	AP
926002	P206850	TRUX		P206327	AP	9373	P270536	TRUX	94238001	P270539	VMER	9504	P206603	AP
926123	P270531	HSTR	9333	P206325	AP	9374	P270538	TRUX	942380011	P270539	VMER		P206603	TRUX
9265	P207352	AP		P206325	TRUX		P270538	AP	94286	P207359	CMI	9506	P207596	TRUX
92659	M080018	DRSS	9334	P206339	AP	9375	P270539	TRUX	9429	J009429	WLKR		P207596	AP
	M080018	KTSU	9335	P206318	AP		P270539	AP		J009429	AP	9514	J009514	TRUX
92673	P206297	TRUX		P206318	TRUX	9376	P270540	TRUX	9430	P206641	TRUX		J009514	AP
92674	P206298	TRUX		P206318	TRUX		P270540	AP	94307	M085008	RKRM	9516	J009516	AP
						9377	P270541	AP	944130	X004536	OK			

CROSS REFERENCE

Cross Reference

(See first page of this section for Manufacturer's Code Listing)



CROSS REFERENCE

Mfgs. No.	Our No.	Mfg. Code	Mfgs. No.	Our No.	Mfg. Code	Mfgs. No.	Our No.	Mfg. Code	Mfgs. No.	Our No.	Mfg. Code	Mfgs. No.	Our No.	Mfg. Code		
		J009516.....	TRUX		J009613.....	AP		9690.....	P222756.....	TRUX		992L11.....	M090535.....	DREO		
9518.....	J009518.....	AP	9614.....	J009614.....	TRUX		9692.....	P222757.....	TRUX		992L12.....	M090544.....	DREO	A0410342.....	M090535.....	FRTL
	J009518.....	TRUX		J009614.....	AP		9693.....	P222758.....	TRUX		992L13.....	M100464.....	DREO	A04103420.....	M090535.....	FRTL
9531.....	P207322.....	AP	9615.....	P206607.....	TRUX		9694.....	P222759.....	TRUX		9941436.....	J190003.....	ENGN	A0410561.....	M100464.....	FRTL
9532.....	P207324.....	AP		P206607.....	AP		9696.....	X007784.....	GOE		9948.....	P206331.....	ICAB	A04105611.....	M100464.....	FRTL
9533.....	P207325.....	AP	96156.....	M080018.....	JNDR		9697.....	X007785.....	GOE		994819.....	X004536.....	TKNG	A04105620.....	M090544.....	FRTL
9534.....	P207326.....	AP	9616.....	P210110.....	TRUX		9698.....	X007824.....	GOE		99487900034.....	X004482.....	FXBL	A0410617.....	M090544.....	FRTL
9535.....	P207327.....	AP		P210110.....	AP		9699.....	X007805.....	GOE		9949979.....	M090544.....	KOEK	A04106170.....	M090544.....	FRTL
9536.....	P207328.....	AP	9617.....	J009614.....	TRUX		9701300001.....	M090535.....	BRED		997722C1.....	M090538.....	NAVI	A04106171.....	M090544.....	FRTL
9537.....	P207329.....	AP	9618.....	J009618.....	TRUX		9704.....	P270542.....	TRUX		998025C1.....	M085171.....	NAVI	A0410618.....	M100464.....	FRTL
9538.....	P207330.....	AP		J009618.....	AP		9706292.....	X007824.....	NH		998580.....	M090544.....	VLVO	A04106180.....	M090544.....	FRTL
9539.....	P206346.....	AP	9620.....	P206344.....	AP			X007824.....	VSTL			M090544.....	WGMC	A04106181.....	M100464.....	FRTL
9540.....	P207331.....	AP	96206.....	P207402.....	CMI		9706293.....	X007785.....	CASE		9989101A.....	P206340.....	ENGN	A04106189.....	M100464.....	FRTL
9541.....	P207332.....	AP	96207.....	M120751.....	CMI			X007805.....	NH		9990000767.....	P206602.....	BIAM	A04108790.....	M090535.....	FRTL
9542.....	P206349.....	AP	96208.....	P206365.....	CMI		9706674.....	P207298.....	NH			P206602.....	ONTB	A04108791.....	M090535.....	FRTL
9545.....	P207345.....	AP	96223.....	M001505.....	CMI			P207298.....	VSTL		9999.....	M060251.....	TMCO	A04109610.....	M100464.....	FRTL
9546.....	P207346.....	AP	9623.....	X007784.....	TRUX		9707490.....	P207297.....	NH		99M090362.....	M090362.....	HARLEY	A04114470.....	M100464.....	FRTL
9547.....	J009547.....	AP	9623618.....	P206407.....	MCII			P207297.....	VSTL		99M100464.....	M100464.....	HARLEY	A0411447000.....	M100464.....	FRTL
9550.....	P270542.....	HDMI	9624.....	X007785.....	TRUX		9713.....	P207582.....	TRUX		9F6433.....	M120100.....	CAT	A04114471.....	M100464.....	FRTL
9554.....	P206347.....	AP	9628.....	P224841.....	TRUX		9714.....	P207567.....	TRUX		9H0047.....	M120100.....	LKBT	A04116940.....	M100465.....	FRTL
9557.....	P207339.....	AP	9629.....	J009629.....	TRUX		9715.....	P207584.....	AP			M120100.....	FMC	A04116941.....	M100464.....	FRTL
9559.....	P207354.....	AP		J009629.....	AP			P207584.....	GOE		9H0547.....	P207339.....	LKBT	A04117170.....	M100463.....	FRTL
9560.....	J009560.....	AP	9630.....	X004962.....	GOE		9722.....	P206326.....	TRUX		9H0554.....	M090538.....	FMC	A04117171.....	M100463.....	FRTL
9561.....	P207347.....	AP		X004962.....	TRUX		972204010.....	P206336.....	BOSS			M090538.....	LKBT	A04118400.....	M100465.....	FRTL
9562.....	P207349.....	AP	9631.....	J009631.....	AP		972303010.....	P206334.....	BOSS		9H47.....	M120100.....	FMC	A04118403.....	M100465.....	FRTL
9563.....	P207350.....	AP	9632.....	J009632.....	AP		972335010.....	P206335.....	BOSS		9H54.....	M090538.....	FMC	A04118430.....	M100465.....	FRTL
9564.....	P207351.....	AP	9633.....	J009633.....	AP		9724.....	P206512.....	TRUX		9HB910.....	M100463.....	OKSH	A0412094.....	M100465.....	FRTL
9566.....	P207353.....	AP	9635.....	J009635.....	AP		9725.....	P206511.....	TRUX		9LT400.....	M090362.....	RKRM	A04120940.....	M100465.....	FRTL
9567.....	P207354.....	AP	9636.....	J009636.....	AP		9726292.....	X007824.....	VSTL		9LT500.....	M090072.....	RKRM	A0412096000.....	X007785.....	MERS
9571.....	P271507.....	TRUX	9637.....	J009637.....	AP		9730.....	J190060.....	TRUX		9N8185.....	M190002.....	CAT	A0412096001.....	X007784.....	MERS
	P271507.....	AP	9639.....	J009639.....	AP		9731.....	J190061.....	TRUX		9N8198.....	M065044.....	CAT	A04122700.....	M100463.....	FRTL
9572.....	P271508.....	AP	9640.....	J009640.....	AP		9732.....	J009623.....	TRUX			M065044.....	RYGO	A04125560.....	M100465.....	FRTL
9573.....	P270837.....	AP	9641.....	J009641.....	AP		9733.....	X007785.....	TRUX		9S0038.....	P208326.....	CAT	A0412966.....	M100465.....	FRTL
	P270837.....	TRUX	9642100072.....	M100464.....	MTWC		97342400232.....	M120108.....	FXBL		9S200.....	P270532.....	HDMI	A04129660.....	M100465.....	FRTL
9575.....	P270838.....	TRUX		M100464.....	GRVE		9737.....	J009612.....	TRUX		9S225.....	P270533.....	HDMI	A04140750.....	M100580.....	FRTL
	P270838.....	AP	9642100076.....	M085078.....	GRVE		97496413.....	P206409.....	IVECO		9S250.....	P270534.....	HDMI	A0414075000.....	M100580.....	FRTL
9577.....	P271511.....	AP		M085078.....	MTWC		97926300001.....	M120189.....	UCP		9S275.....	P270535.....	HDMI	A0414075001.....	M100580.....	FRTL
	P271511.....	AP	9644.....	J009644.....	AP			M120189.....	FXBL		9S300.....	P270536.....	HDMI	A04164220.....	M120365.....	MERS
9581.....	P206521.....	TRUX	9645.....	J009645.....	AP		979541R91.....	M090544.....	NAVI		9S300CP.....	P271507.....	HDMI	A0416422000.....	M120365.....	CAT
9587.....	P206617.....	GOE	9648.....	J009648.....	AP		97977600026.....	P206403.....	FXBL		9S350.....	P270538.....	HDMI		M120365.....	MERS
	P206617.....	TRUX		J009648.....	TRUX		97977600238.....	P210110.....	FXBL		9S350CP.....	P271508.....	HDMI	A0416704002.....	M110311.....	MERS
	P206617.....	AP	9649.....	J009649.....	TRUX		9798.....	P206511.....	TRUX		9S400.....	P270539.....	HDMI		M110311.....	FRTL
9598.....	P206367.....	GOE		J009649.....	AP		9799.....	P206512.....	TRUX		9S400CP.....	P270837.....	HDMI	A0495200.....	P206410.....	FRTL
	P206367.....	AP	964L1.....	M085008.....	WGMC		980001350.....	X004539.....	GAME		9S450.....	P270540.....	HDMI	A0534253.....	P206403.....	WTLK
9599.....	P207281.....	TRUX		M085008.....	DLEQ		980011834.....	J190045.....	GAME		9S500.....	P270541.....	HDMI		P206403.....	AECW
9600.....	P270543.....	HDMI	9650.....	J009650.....	AP		9801.....	P206508.....	TRUX		9S500CP.....	P270838.....	HDMI	A0534254.....	P206409.....	WTLK
	P206324.....	AP	9652.....	P222018.....	TRUX		9803.....	P206509.....	TRUX		9S550.....	P270542.....	HDMI	A0546090.....	P206405.....	AECW
	P270543.....	XAIR	9653.....	P222018.....	TRUX		9804.....	P206508.....	TRUX		9S600.....	P270543.....	HDMI	A0574901CJ.....	P213191.....	ONTB
	P206324.....	TRUX	9656.....	J009611.....	TRUX		9805.....	P206510.....	TRUX		9S600CP.....	P271511.....	HDMI		P213191.....	BIAM
	P206324.....	GOE	96600512.....	M060037.....	GRDL		9806.....	P206511.....	TRUX		9XD354.....	M085008.....	RKRM	A07849P05.....	M120108.....	GRDL
9600CP.....	P271511.....	HDMI	9664.....	J190056.....	TRUX		9807.....	P206512.....	TRUX		9XD358.....	M090146.....	RKRM	A118960.....	J190062.....	MNTW
96014149.....	P206327.....	DLTC	9665.....	J190057.....	TRUX		9810.....	P224492.....	TRUX		9XD400.....	M090544.....	RKRM		J190062.....	MTWC
96028649.....	P207667.....	DLTC	9666.....	X007829.....	TRUX		9811.....	P205834.....	TRUX		9XD403.....	M090544.....	RKRM	A118960.....	J190054.....	MNTW
9604.....	J009604.....	TRUX	9667.....	J190059.....	TRUX		982438003.....	X004539.....	CMPR		9XD404.....	M090544.....	RKRM	A1204214.....	M100464.....	PETTI
	X007824.....	AP	9668.....	X007830.....	TRUX		9824380040026.....	P207596.....	CMPR		9XD405.....	M090544.....	RKRM	A1204227.....	M090535.....	PETTI
96047289.....	X007784.....	DLTC	9669.....	X007831.....	TRUX		9824380090004.....	X004476.....	CMPR		9XD408.....	M090544.....	RKRM	A1204265.....	M120225.....	PETTI
96047309.....	P226155.....	DLTC	9670.....	J190062.....	TRUX		9824380090006.....	X004478.....	CMPR		9XD448.....	M090544.....	RKRM	A1204277.....	M120365.....	PETTI
96047569.....	P206410.....	DLTC	9671.....	X009076.....	TRUX		9824380090009.....	X004480.....	CMPR		9XD500.....	M090074.....	RKRM	A134171.....	X004478.....	AMHO
9605.....	J009605.....	TRUX	9672.....	X009076.....	TRUX		9837.....	M070028.....	CRMY		9XD505.....	M090074.....	RKRM	A135428.....	M060037.....	GRVE
	J009605.....	AP	9673152.....	M001702.....	CASE		98423.....	M065065.....	CRMY		9XD508.....	M090535.....	RKRM		M060037.....	Marine
96057001.....	M065044.....	VMER		M001702.....	NH		985250008.....	M080018.....	EIMC		9XD508W.....	M090535.....	RKRM		M060037.....	MTWC
960570011.....	M065044.....	VMER		M001702.....	KBCCO		98525008.....	M080018.....	EIMC		9XD548.....	M090074.....	RKRM		M060037.....	SHUT
9606.....	J009606.....	AP	9674.....	P222744.....	TRUX		986055.....	M060158.....	CHAMP		9Y0176.....	P206407.....	CAT		M060037.....	CASE
	X007824.....	TRUX	9675.....	P222745.....	TRUX		986063.....	P207596.....	CHAMP		9Y0177.....	P206408.....	CAT	A135430.....	M070068.....	CASE
9607.....	X007805.....	AP	9676.....	P222746.....	TRUX		9896.....	P270530.....	TRUX		9Y1561.....	X004484.....	CAT	A139977.....	X004482.....	LRAN
	X007805.....	TRUX	9678.....	P222747.....	TRUX		9897.....	P270531.....	TRUX		9Y3815.....	M001502.....	CAT	A14105.....	P206601.....	IR
9610.....	J009612.....	TRUX	9680.....	P222748.....	TRUX		990023.....	X004478.....	TPOINT		9Y8315.....	M001502.....	CAT	A14105X1.....	P206602.....	IR
	J009612.....	AP	9681.....	P222749.....	TRUX		9901.....	P222748.....	AP					A141843.....	X004480.....	LRAN
9611.....	J009611.....	AP	9682.....	P222750.....	TRUX		9913.....	P206403.....	AP					A141718.....	X004482.....	MCC
	J009611.....	TRUX	9683.....	P222751.....	TRUX		9914.....	P206404.....	AP						X004482.....	CASE
9612.....	J009612.....	AP	9684.....	P222752.....	TRUX		9915.....	P206405.....	AP					A14789.....	X004476.....	IR
	J009612.....	TRUX	9686.....	P222753.....	TRUX		992L1.....	M100464.....	DREO					A162292.....	X004484.....	CASE
9613.....	J009613.....	TRUX	9688.....	P222755.....	TRUX									A1636.....	P206303.....	SAKR

(See first page of this section for Manufacturer's Code Listing)

Mfgs. No.	Our No.	Mfg. Code	Mfgs. No.	Our No.	Mfg. Code	Mfgs. No.	Our No.	Mfg. Code	Mfgs. No.	Our No.	Mfg. Code	Mfgs. No.	Our No.	Mfg. Code
A166072	P207397	ELECT	A3764922604	P207290	FRTL	A8599673	X004536	RNDR	AD302	P206612	RKRM	ASKS191521	M080024	HSTR
A173381	M001703	CASE	A3964920040	X004480	MERS	A8599674	P206306	RNDR	AD308	J009393	RKRM	ASKS477902	M060037	HSTR
A17851	P206409	CASE	A400	P206304	RKRM	A8605649	P270543	RNDR	AD351	P206605	RKRM	AT10646	M045237	JNDR
A19563	P206409	MJPR		X006203	AP	A8605660	X004539	RNDR	AD352	P206613	RKRM	AT177974	M001702	JNDR
A195510	P206509	GRVE		X006203	GOE	A8891	M060250	GNRC	AD354	P207582	RKRM		M001702	CMCO
	P206509	MNTW	A40024	J024746	RKRM	AA200	P206306	RKRM	AD358	P207581	RKRM	AT182928	M001503	JNDR
A200	P207415	RKRM	A40024PL	J024757	RKRM	AA250	P206308	RKRM	AD401	P207567	RKRM	AT252689	X004482	JNDR
A2036926	P206411	CASE	A40036	P208366	RKRM	AA275	P206927	RKRM	AD402	P207567	RKRM		X004482	BEQP
	P206411	PTN	A40036PL	J034746	RKRM	AA300	P208309	RKRM	AD404	P206617	RKRM	AT400	P207367	RKRM
A20AF	J000205	TORCA	A40048	P207295	RKRM	AA30024	P208330	RKRM	AD455	P207582	RKRM		P207367	PDCI
	J000204	TORCA	A40048PL	P207320	RKRM	AA30024PL	J240016	RKRM	AD500	P206615	RKRM	AT4863	M120100	GRDL
A21464	M070008	CASE	A40060	P207290	RKRM	AA30048PL	P207312	RKRM	AD506	P206615	RKRM	AT500	P206849	RKRM
A215675	M120100	JOY	A40060PL	P207301	RKRM	AA33992	M090544	HRSN	AE12380	P206303	XMN		P206849	PDCI
A22AF	J000205	TORCA	A40072PL	P216202	RKRM	AA350	P206310	RKRM		P206303	AMC	AT550	P207368	PDCI
A2300003	M120131	UPTI	A400PL	P207308	RKRM	AA35024	J024748	RKRM	AE15200	P206303	AMC		P207368	RKRM
A2300003001	M120131	UPTI	A40801	M090009	ROUS	AA35024PL	P206385	RKRM	AE20595	P206407	JNDR	AT55914	X004480	JNDR
A2300003A001	M120131	UPTI		M090009	DACR	AA35036PL	P208359	RKRM		P206407	CMCO	AT600	P206850	RKRM
A2300051001	M090823	UPTI	A40AF	J000202	TORCA	AA35048	P206382	RKRM	AE20595P221454	P206407	JNDR	AT650111	M100016	HRSN
A2318028	M085023	PETTI	A41210A	P206344	EAGL	AA35048PL	P206386	RKRM	AE20601	M085023	JNDR	AT65079	X004480	JNDR
A2318037	M085008	PETTI	A41212A	P206344	EAGL	AA400	P206311	RKRM	AE31390	P206343	XMN	AT700	P206851	RKRM
A2318051	M090544	PETTI	A41818A	P206345	EAGL	AA40024	J024748	RKRM		P206343	AMC	AT800	P207369	RKRM
A2320050001	M001505	UPTI	A4194907045	P270536	FRTL	AA40024PL	J024749	RKRM	AE56777	P206601	JNDR	AU100240	M101169	AST
A23476	M065071	CASE	A4194927029	M070068	FRTL	AA40036	P208358	RKRM	AE56778	P206602	CMCO		M101169	ASTEC
A2350040001	P222017	UPTI	A42229	M065030	CASE	AA40036PL	P208359	RKRM		P206602	JNDR	AU100263	M002121	AST
A2350179001	M001865	UPTI		M065030	MCC	AA40048	P206382	RKRM	AEC03276B	M120365	OBIL		M002121	ASTEC
A2350217001	M002164	UPTI	A44332	P206343	AMC	AA40048PL	P206386	RKRM	AEM001327	M001327	PBLT	AU100265	P206311	ASTEC
A2370001001	M100016	UPTI		P206343	XMN	AA40060	P208388	RKRM	AF5108	P206546	XMN		P206311	AST
A2416	P206546	SAKR	A45AF	J000208	TORCA	AA40060PL	P208389	RKRM		P206546	AMC	AU100481	P208386	AST
A24314	M065071	CASE	A4957	M085023	CRAN	AA40072PL	J640005	RKRM	AF9844901	X004962	RVI		P208386	ASTEC
A250	P206301	RKRM	A500	P206305	RKRM	AA40096PL	P209913	RKRM	AG059617	M001432	AGCO	AU100482	M101170	ASTEC
A250179001	M001865	UPTI		X006202	AP	AA400PL	P206384	RKRM	AG123684	M120235	AGCO		M101170	AST
A2522	P206343	SAKR		X006202	TRUX	AA500	P206312	RKRM		M120235	AGEM	AU100484	J008681	ASTEC
A25AF	J000206	TORCA		X006202	GOE	AA50024	J024750	RKRM	AG123921	P208392	AGCO		J008681	ASTEC
A275	P206927	RKRM	A50024	J024747	RKRM	AA50024PL	J024751	RKRM	AG126501	M002123	AGCO	AU100771	P206546	ASTEC
A27AF	J000207	TORCA	A50024PL	J024758	RKRM	AA50036	P208374	RKRM	AG126558	M001668	AGCO		P206546	AST
A300	P206302	RKRM	A50036	P216204	RKRM	AA50036ALZ	P208374	RKRM	AG418A	P208386	EAGL	AU100772	P206602	ASTEC
	X004478	TRUX	A50036PL	P216204	RKRM	AA50036PL	P208375	RKRM	AG418K	P208386	EAGL		P206602	AST
A30024	P208326	RKRM	A50048	P207296	RKRM	AA50048	P206383	RKRM	AG514228	M085078	AGCO	AU103095	P206304	ASTEC
A30024PL	P207318	RKRM	A50048PL	P207321	RKRM	AA50048ALZ	P206383	RKRM	AG514354	X004538	AGCO		P206304	AST
A30036	P208326	RKRM	A50060PL	P207302	RKRM	AA50048PL	P206387	RKRM	AG518A	P208392	EAGL	AU103151	M090594	ASTEC
A30048	P207293	RKRM	A50072PL	P216205	RKRM	AA50060	P208394	RKRM	AG522580	P207282	AGCO		M090594	AST
A30048PL	P207318	RKRM	A50084PL	P209912	RKRM	AA50060ALZ	P208394	RKRM	AG522726	P206409	AGCO	AU103152	M002120	AST
A300PL	J014621	RKRM	A50096	P209910	RKRM	AA50060PL	P208395	RKRM	AG522729	M001503	AGCO		M002120	ASTEC
A306	P206303	UNVL	A50096PL	P209910	RKRM	AA50072	P224600	RKRM	AG524K	J024751	EAGL	AU104372	M002118	AST
A30AF	J000200	TORCA	A500PL	P207309	RKRM	AA50096PL	P209912	RKRM	AG536K	P208375	EAGL		M002118	ASTEC
A31191	M120235	HDMI	A500Q	X006202	AP	AA500PL	P206385	RKRM	AG555185	P206407	AGCO	AU104419	P206301	AST
A312	X006204	TRUX	A503A	P207339	EAGL	AA600	P207419	RKRM	AG605405	M090544	AGCO		P206301	ASTEC
	X006204	GOE	A508A	P207339	EAGL	AB3511K	J014622	EAGL	AH6019	M090538	FMC	AU104420	M001756	AST
	X006202	GOE	A508K	J009547	EAGL	AB418A	P206384	EAGL	AI1000	P206519	EAGL		M001756	ASTEC
	X006204	AP	A50AF	J000203	TORCA	AB518A	P207298	EAGL	AI400	P206525	EAGL	AU104421	M065142	ASTEC
A3345404	M100043	AUXI	A51515A	P206347	EAGL	AB518K	P207309	EAGL	AI900	P206518	EAGL		M065142	AST
A350	P206303	RKRM	A51515K	P207346	EAGL	AB524K	J024758	EAGL	AJ40A	P206336	EAGL	AU104425	X007829	AST
	P206303	RYCO	A52020A	P206348	EAGL	ABPN3535PLA	J009605	ALP	AJ50A	P206337	EAGL		X007829	ASTEC
	P206303	VIC	A5540	X007785	CRAN	ABPN3540EST	J000216	ALP	ALG9047	J190059	AF	AU105143	M090280	ASTEC
A35036	P208350	RKRM	A5543	X007829	CRAN	ABPN3540PLA	J009606	ALP	AP41818A	P207329	EAGL		M090280	AST
A35036PL	P216200	RKRM	A5544	X004538	CRAN	ABPN3540PLB	P222740	ALP	AP51515K	J190019	EAGL	AU106006	M045193	ASTEC
A35048PL	P207319	RKRM	A5545	X007830	CRAN	ABPN3540PLS	J009623	ALP	AP52020A	P206349	EAGL		M045193	AST
A350PL	J014622	RKRM	A5546	X007831	CRAN	ABPN3550EST	J000217	ALP	AR70100	P206411	JNDR	AU106185	M001702	ASTEC
A35108	P206546	PUPR	A5547	X007784	CRAN	ABPN3550PLA	J009607	ALP		P206411	CMCO		M001702	AST
A35AF	J000201	TORCA	A5548	X004539	CRAN	ABPN3550PLB	P222741	ALP	AS25A	J000206	GRMC	AU106186	M001593	ASTEC
A36280	M070050	DACR	A56029	M070028	CASE	ABPN3550PLS	J009624	ALP	AS2A	J000204	GRMC		M001593	AST
A3764910140	P206521	FRTL	A600	P207559	RKRM	AC412	P206374	EAGL	AS300	J000200	AP	AU106262	P207295	ASTEC
A3764910240	P206519	FRTL	A602499001	P207332	VMER	AC504	P206375	EAGL	AS350	J000201	AP		P207295	AST
A3764920159	P206554	FRTL	A60AF	J000209	TORCA	ACU5266	X004478	ROVR	AS35A	J000201	GRMC	AU106263	M001503	AST
A3764920259	P206552	FRTL	A6290	M101170	GNRC		X004478	MULTI	AS3A	J000200	GRMC		M001503	ASTEC
A3764920640	X007785	FRTL	A6814910400	M120448	FRTL		X004478	UNIP	AS400	J000202	TRUX	AU106905	P206304	ASTEC
A3764921340	X007784	FRTL	A7471	P206303	XMN		X004478	LEVY		J000202	AP		P206304	AST
A3764921440	P206602	FRTL		P206303	AMC	ACU5267	X004480	MULTI	AS4A	J000202	GRMC	AU109775	M085409	AST
A3764921940	X007830	FRTL	A8593386	X006203	RNDR		X004480	UNIP	AS500	J000203	AP		M085409	ASTEC
A3764922104	P206311	FRTL	A8596162	P226148	RNDR		X004480	ROVR		J000203	TRUX	AU110235	M002119	ASTEC
A3764922204	P208388	FRTL	A8599672	P206403	RNDR		X004480	LEVY	AS5A	J000203	GRMC		M002119	AST
						AD300	P207619	RKRM						

CROSS REFERENCE

Cross Reference

(See first page of this section for Manufacturer's Code Listing)



CROSS REFERENCE

Mfgs. No.	Our No.	Mfg. Code	Mfgs. No.	Our No.	Mfg. Code	Mfgs. No.	Our No.	Mfg. Code	Mfgs. No.	Our No.	Mfg. Code	Mfgs. No.	Our No.	Mfg. Code
AU110242	P208330	AST	B40AA	P222748	TORCA	C13941	P206343	AMC	CB01477039	P207354	CMCO			M065030
	P208330	ASTEC	B40SA	P222757	TORCA		P206343	XMN	CB01477040	J024837	CMCO	CY5018	P206410	HOBT
AU110244	J009604	AST	B412	J000219	TRUX	C1555230BD	M100048	FMCO	CB01477041	J190003	CMCO	CY5046	J009487	HOBT
	J009604	ASTEC	B45AA	P222749	TORCA	C1591	M120367	GNRC	CB01477127	M002120	CMCO	CZ78312	M065044	CMPR
AU110306	P206379	AST	B45SA	P222758	TORCA	C18A3779	P206411	CCML	CB01477133	J190025	CMCO			
	P206379	ASTEC	B500	J000217	AP	C1TT5230AT	M100049	FMCO	CB01481031	P207332	CMCO			
AU110479	P207394	ASTEC		P206300	RKRM	C1TT5230BD	M100464	FMCO	CB01486387	J024838	CMCO			
	P207394	AST		J000217	TRUX	C1TT5230DB	M100048	FMCO	CB01486531	M002134	CMCO			
AU110808	P207322	ASTEC	B500500	M100465	AJMC	C2519859	M120189	URIG	CB01486532	P206554	CMCO			
	P207322	AST	B500V	J000217	TRUX	C2785030	M090362	URIG	CB01486535	P206323	CMCO			
AU111497	P206370	AST	B50AA	P222750	TORCA	C2785032	P206410	URIG	CB01486536	M001865	CMCO			
	P206370	ASTEC	B50SA	P222759	TORCA	C28A1475	M100463	CCML	CB01487844	M002117	CMCO			
AU111507	P206370	ASTEC	B600	J000218	TRUX	C2TA5230A	M100049	FMCO	CB11472557	X006202	CMCO			
	P206370	AST		J000218	AP	C2TZ5230A	M100049	FMCO	CDD000009	X004482	CUMS			
AU111640	P206400	AST	B60AA	P222751	TORCA	C300	P206544	RKRM	CDD000010	X004484	CUMS			
	P206400	ASTEC	B7TZ5230A	M060232	FMCO	C3440411	M080024	PTN	CDD000012	M120100	CUMS			
AU111836	J000221	AST	B8091034	P206407	ESSEX		M080024	CASE	CDD000013	M120235	CUMS			
	J000221	ASTEC	BACU5261	X004480	ROVR	C350SS	P206544	RKRM	CDD000028	P206315	CUMS			
AU111838	J000220	AST		X004480	LEYL	C35148	P206546	AMC	CDD000029	P206323	CUMS			
	J000220	ASTEC		X004480	UNIP		P206546	XMN	CDD000030	P206328	CUMS			
AU111840	J000227	AST	BB212	J000211	AP	C3TA5230S	M090544	FMCO	CDD000031	P206554	CUMS			
	J000227	ASTEC	BB234	J000213	AP	C3TS5230H	M120100	FMCO	CDD000115	X004478	CUMS			
AU112635	M001432	AST	BB300	J000214	AP	C3TZ5230B	M065065	FMCO	CDD000118	P206552	CUMS			
	M001432	ASTEC	BB312	J000215	AP	C3TZ5230F	M090544	FMCO	CDD000122	M120225	CUMS			
AU113915	M085056	ASTEC	BB400	J000216	AP	C400	P206546	RKRM	CDD000123	P206555	CUMS			
	M085056	AST	BC200FLAT	X004536	TESSI	C4000035	M100464	VLVO	CDD000433	P226142	CUMS			
AU118505	P207347	AST	BC225FLAT	X004537	TESSI	C43328	M085008	PETTI	CDD000468	P206283	CUMS			
	P207347	ASTEC	BC250FLAT	X004476	TESSI	C4342589	P270536	CLRK	CDD000668	J009648	CUMS			
AU119660	P222746	ASTEC	BC275FLAT	X004538	TESSI	C4P206347	P206347	VLVO	CDD000669	P206344	CUMS			
AX1630	P207308	SRSD	BC300FLAT	X004478	TESSI	C4P206602	P206602	VLVO	CE200	P207411	RKRM			
AY2582	M085023	ELGN	BC400FLAT	X004482	TESSI	C4P206603	P206603	VLVO	CE250	P206366	RKRM			
			BC500FLAT	X004484	TESSI	C4TS5230A	M085023	FMCO	CE275	P207413	RKRM			
			BC600FLAT	X004539	TESSI	C4TZ5230B	M085023	FMCO	CE300	P206367	RKRM			
			BCU2364	X004482	LEYL	C500	P206547	RKRM	CE350	P206368	RKRM			
				X004482	ROVR	C500SS	P206547	RKRM	CE400	P206369	RKRM			
				X004482	MULTI	C5668	J000232	GNRC	CE500	P206370	RKRM			
				X004482	UNIP	C5TS5230A	M100048	FMCO	CE600	P207414	RKRM			
B06105	P206302	HOIST	BCU7273	X004476	UNIP	C5TZ5230C	M060232	FMCO	CL1352	M070028	MARA			
	P206309	HOIST		X004476	LEYL	C6119	J000222	GNRC		M070008	DRSS			
	P226144	HOIST		X004476	ROVR	C6H0006	M100572	FMC		M070008	WBCCO			
B102002	P213191	ENGL			EAGL		M100572	LKBT	CMP00290	P206409	ATCO			
B102003	J000203	ENGL			CASE		M100572	LBX	CMP00417	X004480	ATCO			
B102042	J000228	ENGL			CASE				CMV07108XO	P206326	BMY			
B102043	X007831	ENGL			CASE				CMV07109XO	X004482	BMY			
B106203	P207327	ENGL			CASE				CMV07110XO	X004478	BMY			
B126366	M100464	LRAN			CASE				CN356A	P206368	GRMC			
B126367	M090535	LRAN			CASE				CN36A	P206367	GRMC			
B126705	M090158	LRAN			CASE				CN46A	P206369	GRMC			
B144188	M120225	LRAN			CASE				CN56A	P206370	GRMC			
B200	J000210	TRUX			CASE				CN66A	P207414	GRMC			
	J000210	AP			CASE				CO200	P207405	RKRM			
B20SA	P222752	TORCA			CASE				CO250	P206371	RKRM			
B212	J000211	TRUX			CASE				CO300	P206372	RKRM			
	J000211	AP			CASE				CO350	P206373	RKRM			
B214	J000212	AP			CASE				CO400	P206374	RKRM			
	J000212	TRUX			CASE				CO500	P206375	RKRM			
B234	J000213	TRUX			CASE				CO500PL	P207408	RKRM			
	J000213	AP			CASE				CO600	P207408	RKRM			
B253311	M090594	DRSS			CASE				CP358A	P206373	GRMC			
B25AA	P222744	TORCA			CASE				CP38A	P206372	GRMC			
B25SA	P222753	TORCA			CASE				CP48A	P206374	GRMC			
B27AA	P222745	TORCA			CASE				CP58A	P206375	GRMC			
B27SA	P222754	TORCA			CASE				CP68A	P207408	GRMC			
B300	J000214	AP			CASE				CSP40024	J024748	RKRM			
	J000214	TRUX			CASE				CSP40048	P206382	RKRM			
B30AA	P222746	TORCA			CASE				CSP50024PL	J024751	RKRM			
B30SA	P222755	TORCA			CASE				CT250	P206361	RKRM			
B312	J000215	TRUX			CASE				CT300SS	P206544	RKRM			
	J000215	AP			CASE				CX162830	M065030	AMC			
B35AA	P222747	TORCA			CASE					M065030	XMN			
B35SA	P222756	TORCA			CASE					M065030	AGCO			
B379720	M085056	NLSN			CASE					M065030	FENT			
B400	J000216	TRUX			CASE									
	P205976	RKRM			CASE									
	J000216	AP			CASE									
B400V	J000216	TRUX			CASE									

(See first page of this section for Manufacturer's Code Listing)

Mfgs. No.	Our No.	Mfg. Code	Mfgs. No.	Our No.	Mfg. Code	Mfgs. No.	Our No.	Mfg. Code	Mfgs. No.	Our No.	Mfg. Code	Mfgs. No.	Our No.	Mfg. Code
D3TZ5230D	M065065	FMCO	DA3590825	M100464	HRSN	E1HS5230AA	M100463	FMCO	E650105	M065065	RYGO	EN170	M070050	WPOW
D45000242	M090091	KW	DA3590827	M085023	HRSN	E1HT5225BA	M110014	FMCO	E704	M120382	EAGL	EN171	M090009	WPOW
D45000248	M100016	KW	DA3590829	M090538	HRSN	E1HZ5230A	M110014	FMCO	E705	M120566	EAGL	EN20948	M070068	ARDCO
D45000259	M120450	KW	DA359088	M090074	HRSN	E201	M085023	EAGL	E707	M100213	EAGL	EN20949	M070008	ARDCO
D45000266	M101182	KW	DA81670	M120108	VRNR	E202	M065065	EAGL	E708	M090547	EAGL	EN20951	M085206	ARDCO
D45000282	M100944	KW	DC200	X004536	UCP	E203	M065065	EAGL	E725	M065030	EAGL		M085206	PTBN
D45000307	M100463	KW	DC225	X004537	UCP	E204	M065065	EAGL	E735	M070069	EAGL	ENC0144	M070068	ARDCO
D45009558	M110849	KW	DC250	X004476	UCP	E206	M100048	EAGL	E740	M080024	EAGL	ENE0004	M100048	ARDCO
D49456	M070008	LRAN	DC275	X004538	UCP	E208	M085008	EAGL	E750	M090091	EAGL	ENE0188	P206333	PTBN
D4HA5225EA	M090146	FMCO	DC300	X004478	UCP	E209	M060232	EAGL	E8A0593	M085411	LKBT	ENE0189	P206334	ARDCO
D4HZ5230C	M090146	FMCO	DC350	X004480	UCP	E20ST	J000210	TORCA	E8A0617	M002119	LKBT		P206334	PTBN
D4NN5230F	M085078	NH	DC400	X004482	UCP	E22ST	J000212	TORCA	E8A0618	P206315	LKBT	ENE0229	P207367	PTBN
	M085078	CASE	DL0201001	M120189	NPRT	E230	M065065	EAGL	E8A0619	M001503	LKBT		P207367	ARDCO
D5443	J190003	GNRC		M120189	NEPN	E2355	M085008	EAGL	E8A0620	M001702	LKBT	ENE0292	P206397	ARDCO
D5443R	J190003	GNRC		M120189	NPLN	E25ST	J000211	TORCA	E8HT5225LA	M100807	FMCO	ENE0298	P207361	ARDCO
D5HA5225HA	M100464	FMCO	DOHZ5230F	M120135	FRTL	E27ST	J000213	TORCA	E8HZ5230H	M100807	FMCO	ENE0299	P206556	ARDCO
D5HS5230EA	M120225	FMCO		M120135	FMCO	E2H5225EA	M100146	FMCO	E9218031	M090095	ECLD	ENE0300	P207419	ARDCO
D5HZ5230G	M100464	FMCO	DP51654	M060250	DFLX	E2HT5225AZB	M120366	FMCO	EB5665	M120418	HOBT	ENE0308	P206849	ARDCO
D5NN5N202A	M070068	NH	DP51654Q	M060250	DFLX	E2HT5225BCA	M100465	FMCO	EB5728	P206399	HOBT	ENE0337	M070068	ARDCO
	M070068	FMCO	DSC200	X004536	TAC	E2HT5225BGA	M100465	FMCO	EB5792	P208364	HOBT	ENE0340	P206336	ARDCO
D5TA5225BDA	M090538	FMCO	DSC250	X004476	TAC	E2HT5225BHA	M100464	FMCO	EB5922	M120418	HOBT	ET5048	M065071	HOBT
D5TA5225BDA1	M090538	FMCO	DSC275	X004538	TAC	E2HT5225BM1AM100465	FMCO	EB5933	P206326	HOBT	EX002000800000	P206407	PSIS	
D5TQ5225BDA	M090538	FMCO	DSC300	X004478	TAC	E2HT5225BMA	M100465	FMCO	EB5944	P206510	HOBT	EX003000100000	P206507	PSIS
D5TZ5230AC	M065065	FMCO	DSC300N	J000214	TAC	E2HT5225BMA	M100465	FMCO	EB5945	P206411	HOBT	EX300017	M060037	RNCO
D5TZ5230AF	M065065	FMCO	DSC350	X004480	TAC	E2HT5230ANA	M100464	FMCO	EB5946	P207619	HOBT	EX300021	M060158	RNCO
D5TZ5230AH	M090538	FMCO	DSC400	X004482	TAC	E2HZ5225AFB	M110012	FMCO	EB5954	P206315	HOBT	EX300040	M100146	RNCO
D5TZ5230CM	M065065	FMCO	DSC500	X004484	TAC	E2HZ5230G	M085189	FMCO	EB5955	P206365	HOBT	EX302240	P208366	RNCO
D5TZ5230J	M065065	FMCO	DWM4410	M100464	PDCl	E2HZ5230I	M100465	FMCO	EB5959	P206407	HOBT	EX305528	P270531	RNCO
D6667R	P206615	GNRC	DX004482	X004482	DD	E2HZ5230R	M085172	FMCO	EB5960	P206320	HOBT	EX306040	P206410	RNCO
D6HS5230AA	M100464	FMCO	DX004484	X004484	DD	E2HZ5230S	M085172	FMCO	EB5967	P207354	HOBT	EX306140	P206525	RNCO
D6HS5230DA	M090072	FMCO	DX3590812	M100049	HRSN	E2HZ5230Y	M090544	FMCO	EB5969	P207328	HOBT	EX306190	P206519	RNCO
D6NN5C208A	P270534	NH	DX3590813	M090535	HRSN	E2HZ5230Z	M110012	FMCO	EB5972	P206335	HOBT	EZ3	J000214	GRMC
	P270534	FIAT	DX359089	M090544	HRSN	E301	M090538	EAGL	EB5975	J009649	HOBT	EZ35	J000215	GRMC
	P270534	CASE				E302	M120100	EAGL	EB5982	P207352	HOBT	EZ4	J000216	GRMC
	P270534	FMCO				E303	M120365	EAGL	EB6010	M065044	HOBT	EZ5	J000217	GRMC
						E30ST	J000214	TORCA	EB6017	P206851	HOBT			
D71668	M085023	LRAN				E31505	M120108	EAGL	EB6025	P226157	HOBT			
D7204	P206369	GNRC				E32841	M090159	MJPR	EB6071	P206339	HOBT			
D7HT5225AJA	M100464	FMCO					M090159	CASE	EB6073	M002118	HOBT			
D7HT5225BEA	M100463	FMCO				E35ST	J000215	TORCA	EBC200	X004536	CLMP	F000687	X004538	TJAK
D7HT5225BNA	M120197	FMCO				E3HT5225RA	M100464	FMCO	EBC225	X004537	CLMP		X004538	JNDR
D7HT5225CLA	M100465	FMCO				E3HZ5230B	M110189	FMCO	EBC250	X004476	CLMP	F004250	M085078	JNDR
D7HT5230BEA	M100465	FMCO				E401	M100049	EAGL	EBC275	X004538	CLMP	F010587	X004478	TJAK
D7HT5230FRA	M100465	FMCO				E4041463	X004539	ECLD	EBC300	X004478	CLMP	F024660	M070068	TJAK
D7HT5230FYA	M100463	FMCO				E4043701	X004482	ECLD	EBC350	X004480	CLMP	F054725	M070069	TJAK
D7HT5230GEA	M100465	FMCO				E4047421	X004484	ECLD	EBC350ALZ	X006204	CLMP	F10123	J190059	XMN
D810093	M060037	DAEW				E40ST	J000216	TORCA	EBC400	X004482	CLMP		J190059	AMC
D810150	M070068	DAEW				E45ST	J000219	TORCA	EBC400ALZ	X006203	CLMP	F1200	X004536	EAGL
D810174	M065030	DAEW				E4HS5225EA	M120365	FMCO	EBC500	X004484	CLMP	F122005	X004962	TJAK
D830151	M070069	DAEW				E4HT5230BA	M085189	FMCO	EBC500ALZ	X006202	CLMP		X004962	JNDR
D8HS5225CA	M100464	FMCO				E4HZ5230B	M085172	TERN	EBC600	X004539	CLMP	F1225	X00437	EAGL
D8HS525EA	M100463	FMCO				E4HZ5230C	M085172	FMCO	ECL1828	X004482	PAI	F1250	X004476	EAGL
D8HT5230BA	M100465	FMCO				E4NN5B233AA17M	X004476	NH	ECL1829	X004484	PAI	F1275	X004538	EAGL
D8HT5230CA	M100465	FMCO				E4NN5N231AA	X004536	NH	EE100601	M120225	OKSH	F1300	X004478	EAGL
D8HZ5230AB	M100463	FMCO					X004536	FMCO	EEM1879	M090544	PAI	F1350	X004480	EAGL
D8HZ5230AE	M100464	FMCO				E110	M085171	EAGL	EEM1895	M090544	PAI	F1400	X004482	EAGL
D8HZ5230AF	M100465	FMCO				E111	M100466	EAGL	EEM1899	M090544	PAI	F1450	X004962	EAGL
D8HZ5230AT	M100465	FMCO				E112	M100465	EAGL	EEM1901	M090535	PAI	F1500	X004484	EAGL
D8HZ5230AV	M100463	FMCO				E114	M100807	EAGL	EEM1917	M120382	PAI	F1600	X004539	EAGL
D8HZ5230B	M100465	FMCO				E115	M100695	EAGL	EF9518	P206641	EAGL	F18658	M090170	FRYM
D8HZ5230F	M100465	FMCO				E117	M090595	EAGL	EF9520	P206512	EAGL	F18685	M045237	CASE
D8TZ5230AC	M090538	FMCO				E119	M100582	EAGL	EG0938	M045237	EGL	F19008	M090210	FRYM
D8TZ5230CF	M065065	FMCO				E123	M070008	EAGL	EH0201001	M100048	NPLN	F240	P206602	EAGL
D9HS5225JA	M100464	FMCO				E12574828	P207596	ECLD	EH11068196	P207394	ECLD	F250	P206603	EAGL
D9HZ5230A	M085172	FMCO				E12651880	M122300	ECLD	EH6232815	M120131	ECLD	F2500	J000217	EAGL
D9HZ5230A1	J009612	FMCO				E130	M085023	EAGL		M120131	ECLD	F2500PF	J009624	EAGL
DA0796	M065034	VBBCO				E13039	M085023	EAGL		M120131	VME	F250K	P206611	EAGL
DA2638	M065034	VBBCO				E135	M070028	EAGL		M120131	VLVO	F260	P207596	EAGL
	M065034	KTSU				E1351	M070028	EAGL				F260K	P207598	EAGL
	M065034	DRSS				E1405	M085171	EAGL				F2A0375	M100580	LKBT
DA3580811	M120100	HRSN										F300106	M070068	JNDR
DA3590811	M120100	HRSN											M070068	TJAK
DA3590823	M090544	HRSN										F330	J000227	EAGL
DA3590824	M100464	HRSN										F335	J000228	EAGL

CROSS REFERENCE

Cross Reference

(See first page of this section for Manufacturer's Code Listing)



CROSS REFERENCE

Mfgs. No.	Our No.	Mfg. Code	Mfgs. No.	Our No.	Mfg. Code	Mfgs. No.	Our No.	Mfg. Code	Mfgs. No.	Our No.	Mfg. Code	Mfgs. No.	Our No.	Mfg. Code
F3A0066	P206385LKBT	FL5	X004484GRMC	GD183184	P206411CMPR	H360339430	X004536KTSU	HD2220	M065030HAVA
F5225	P206404EAGL	FL5A	X006202GRMC		P206411LROI	H37006	M070008GALN	HD2230	M070068HAVA
F5300	P206407EAGL	FL6	X004539GRMC	GD200SPQ063	M120100LROI	H400	J000230AP	HD2240	M070069HAVA
F5350	P206409EAGL	FMC090091	M090091KW	GD2016573	M120108LROI		J000230TRUX	HD2250	M080024HAVA
F5400	P206410EAGL	FP1503535	M090210PTBN	GD202SPT063	M122300LROI		P206525RKRM	HD2260	M090091HAVA
F5500	P206411EAGL	FS1719	J190059SAKR	GD302650	X004539LROI	H400P	P206410TRUX	HD2265	M100016HAVA
FL5912	M080018RDTC	FS30018	P206552RKRM	GD5000268	P206410LROI	H412	J000231AP	HD2500	M065065RKRM
FA3060	P206303FSA	FS35012	J240005RKRM	GD5826466	X004480LROI		J000231TRUX	HD2500	M065065RKRM
FB300	M001702TRUX	FS35018	P206553RKRM	GD5827462	M090158LROI	H500	J000232TRUX	HD2501	M065065RKRM
FB350	M001502TRUX	FS35024	J024850RKRM	GD5840015	M090535LROI		J000232AP	HD2502	M065065RKRM
FB388	M001432TRUX	FS40018	P206554RKRM	GD7144099	P270536LROI		P206526RKRM	HD2503	M065065RKRM
FB400	M002164TRUX	FS40024	J024836RKRM	GD98J11	P206411LROI	H500P	P206411TRUX	HD25037	M065065RKRM
FB400C	M002164TRUX	FS40030	J024836RKRM		P206411CMPR	H500Z	J000232TRUX	HD25039	M065065RKRM
FB450	M001703TRUX	FS40036	J034673RKRM	GD98J14	P206407LROI	H556	M002121RKRM	HD2510	M065065RKRM
FB4C	P206610GRMC	FS50012	J240007RKRM	GD98J3	P206410LROI	H580	P206517RKRM	HD25739	M065065RKRM
FB4ZN	P206602GRMC	FS50018	P206555RKRM	GD98J8	P206404LROI	H600	J000233AP	HD278	M065065RKRM
FB500	M001865TRUX	FS50024	J024836RKRM	GF3120	P226140GRMC		J000233TRUX	HD3078	M085023RKRM
FB500C	M001865TRUX	FS50036	J024837RKRM	GF35120	P226141GRMC		P206515RKRM	HD325	M065065RKRM
FB5C	P206611GRMC	FT300	P226129RKRM	GF35300	P226154GRMC	H700	P206516RKRM	HD350	M070028RKRM
FB5ZN	P206603GRMC	FT300SS	P226132RKRM	GF412	P224479GRMC	H811	P206520RKRM	HD3530	M085008RKRM
FB600	M001505TRUX	FT350	P226154RKRM	GF4120	P226142GRMC	H850	P206517RKRM	HD357	M085008RKRM
FB6C	P207598GRMC	FT350SS	P226133RKRM	GF418	J024754GRMC	H900	P206518RKRM	HD358	M085008RKRM
FB6ZN	P207596GRMC	FT400	P226155RKRM	GF424	J024835GRMC	H92659	M080018GALN	HD359	M070028RKRM
FBC200	X004536PDCI	FT400SS	P226156RKRM	GF4300	P226155GRMC	HC2738	M070069FMC	HD363	M070028RKRM
FBC225	X004537PDCI	FT500	P226157RKRM	GF436	J034743GRMC		M070068LKBT	HD3631	M070028RKRM
FBC250	X004476PDCI	FT500SS	P226158RKRM	GF512	P224481GRMC	HD0714	X004536HAVA	HD3810	X004478HAVA
FBC275	X004538PDCI	FTG2001925	P226148RKRM	GF5120	P226143GRMC	HD0716	P206279HAVA	HD3811	X004480HAVA
FBC300	X004478PDCI	FTG2501925	P226149RKRM	GF518	J024755GRMC	HD0718	P206280HAVA	HD3812	X004482HAVA
FBC350	X004480PDCI	FTG3001925	P226129RKRM	GF524	J024837GRMC	HD0732	P206313HAVA	HD3815	X004484HAVA
FBC350A	X006204PDCI	FTG3001925	P226129RKRM	GF5300	P226157GRMC	HD0736	P206315HAVA	HD3995	M085084HAVA
FBC400	X004482PDCI	FTG35015	P226154RKRM	GF536	J034744GRMC	HD0738	P206316HAVA	HD4012	M100146HAVA
FBC400A	X006203PDCI	FTG40015	P226155RKRM	GF6120	P226150GRMC	HD0740	P206317HAVA	HD4020	M045237HAVA
FBC450	X004962PDCI	FTG4001925	P226155RKRM	GF668	J190059AC	HD0746	P206340HAVA	HD4025	M070008HAVA
FBC500	X004484PDCI	FTG4001925	P226155RKRM	GH0201001	M100048NPRT	HD0748	P206342HAVA	HD403	M085171RKRM
FBC500A	X006202PDCI	FTG50015	P226157RKRM		M100048NEPN	HD0750	P206344HAVA	HD4035	M080018HAVA
FBC600	X004539PDCI	FTG5001925	P226157RKRM		M100048NPLN	HD0766	P226141HAVA	HD404	M085171RKRM
FCM060037	M060037PITC	FTS35019	P226133RKRM	GH115PL	P205834RKRM	HD0768	P226142HAVA	HD4040	M090009HAVA
FCM080024	M080024DART	FTS40019	P226156RKRM	GH121PL	P205834RKRM	HD0770	P226143HAVA	HD405	M085171RKRM
	M080024KW	FTS50019	P226158RKRM	GH124PL	P205834RKRM	HD0780	P207333HAVA	HD4070	M090170HAVA
FCM090091	M090091PBLT				GH18C	P206641PDCI	HD0782	P207339HAVA	HD4075	M090158HAVA
	M090091DART				GH18S	P206641GRMC	HD0794	P207382HAVA	HD4080	M120100HAVA
	M090091KW				GH24S	P205834GRMC	HD0804	P208348HAVA	HD4090	M120365HAVA
FCM100016	M100016KW				GR91083250	M065034PTBN	HD0806	P208364HAVA	HD4095	M170101HAVA
FF2391368	M085409NH				GVA4191927029	M070068FRTL	HD0808	P208380HAVA	HD4130	M090535HAVA
FF2391369	M002119NH				GVA4194927029	M070068FRTL	HD0810	P270530HAVA	HD414	M090594HDMI
FF2393512	P206341NH							HD0812	P270531HAVA	HD4170	M100043HAVA
FF2393513	J190013NH							HD0814	P270532HAVA	HD4230	M090535HAVA
FF2405090	P206544NH							HD0818	P270534HAVA	HD4310	M060232HAVA
FF2410384	P206407NH							HD0820	P270535HAVA	HD4315	M060232HAVA
FF2417954	P208326NH							HD0822	P270536HAVA	HD4320	M065065HAVA
FF3043171	P206280NH							HD0824	P270538HAVA	HD4380	M085056HAVA
FG1133	M070008PETTI							HD0826	P270539HAVA	HD449	M085171RKRM
FG400120	P226142RKRM							HD0828	P270540HAVA	HD500	M090074RKRM
FG40018	J024754RKRM							HD0830	P270541HAVA	HD6017	M100043RKRM
FG40024	J024835RKRM							HD0834	P270543HAVA	HD7034	M090538RKRM
FG40036	J034743RKRM							HD0841	P206605HAVA	HD9000	P206407HAVA
FG40048	P226142RKRM							HD0842	P206606HAVA	HD9002	P206409HAVA
FG500120	P226143RKRM							HD0843	P206607HAVA	HD9004	P206410HAVA
FG50018	J024755RKRM							HD0850	P206612HAVA	HD9006	P206411HAVA
FG50024	J024837RKRM							HD0860	P207567HAVA	HD9035	P206406HAVA
FG50036	J034744RKRM							HD0865	P206615HAVA	HD9830	M120197HAVA
FL46070	J190059XMN							HD200	M060232RKRM	HH404X	P207567EAGL
	J190059AMC							HD201	M060232RKRM	HH505X	P207566EAGL
FL2	X004536GRMC							HD2014	H001032HAVA	HT0549	P270539LKBT
FL225	X004537GRMC							HD2015	H001033HAVA	HT0739	M090009FMC
FL25	X004476GRMC							HD2016	H001034HAVA	HT739	M090009FMC
FL275	X004538GRMC							HD2017	H001035HAVA	HW0449	M090544WBCC
FL3	X004478GRMC							HD2030	H001278HAVA		M090544DRSS
FL35	X004480GRMC							HD2031	H001279HAVA			
FL4	X004482GRMC							HD2036	H001284HAVA			
FL404	P206616RKRM							HD2190	M045123HAVA			
FL4A	X006203GRMC							HD2200	M060037HAVA			
									HD2210	M060038HAVA			

(See first page of this section for Manufacturer's Code Listing)

Mfgs. No.	Our No.	Mfg. Code	Mfgs. No.	Our No.	Mfg. Code	Mfgs. No.	Our No.	Mfg. Code	Mfgs. No.	Our No.	Mfg. Code	Mfgs. No.	Our No.	Mfg. Code
I500K	P270838	EAGL		J024748	GRMC	KYX00448210	X004484	DART	L35300404A	J009631	GRMC	L490181A	P206345	GRMC
IE00001	P206340	HOIST	K424SBC	J024749	GRMC	KYX004536	X004536	FRTL	L35300404SA	J009635	GRMC	L500	P206348	RKRM
IE00002	P206393	HOIST	K436EXA	P208366	GRMC		X004536	DART	L35300808A	J009639	GRMC	L50015	P206396	RKRM
IE00006	P206372	HOIST	K436EXC	J034746	GRMC	KYX004537	X004537	WSTI	L35450909A	P206281	GRMC	L50030	J009633	RKRM
IE00012	M080018	HOIST	K436SBA	P208358	GRMC		X004537	DART	L35450909SA	P207352	GRMC	L50030NE	J009637	RKRM
IHO28	M065065	MRMT	K436SBC	P208359	GRMC	KYX004538	X004538	NFC	L35900808A	P206342	GRMC	L50045	P206283	RKRM
IHO859	M070008	FMC	K448EXA	P207295	GRMC		X004538	DART	L35900808SA	J190014	GRMC	L50045ALZ	P206283	RKRM
IHZ8	M065065	MRMT	K448EXC	P207320	GRMC	KYX004539	X004539	DART	L50045F	P207363	GRMC	L50045F	J190025	RKRM
IH859	M070008	FMC	K448SBA	P206382	GRMC	KYX005207	X005207	DART	L35901212A	P224669	GRMC	L50045FPL	P206286	RKRM
IHO0007	P207367	HOIST	K448SBC	P206386	GRMC	KYX005833	X007785	DART	L35901212SA	P207327	GRMC	L50045NEPL	P216169	RKRM
IHO0036	P206849	HOIST	K460EXA	P207290	GRMC	KYX006202	X006202	FRTL	L35901616A	P206343	GRMC	L50045SR	P206286	RKRM
IHO0037	P206850	HOIST	K460EXC	P207301	GRMC	KYX006203	X006203	FRTL	L35901616SA	P207328	GRMC	L50045SR	P207359	RKRM
IHO0038	P206336	HOIST	K460SBA	P208388	GRMC		X006203	WSTI	L35AA	J009605	TORCA	L50045SRPL	P216164	RKRM
IPS0848	M090544	CHLN	K460SBC	P208389	GRMC	KYX004484	X004484	CRAN	L35SA	J190061	TORCA	L50060	J009641	RKRM
IPS2453	M070050	CHLN	K472EXC	P216202	GRMC				L3900606SA	P207362	GRMC	L50060NE	J009645	RKRM
IPS4174	M060232	CHLN	K472SBC	J640005	GRMC				L3900707A	P206340	GRMC	L500F	P206347	RKRM
IPS4174Z	M065065	CHLN	K484EXC	P224635	GRMC				L3901010SA	P207326	GRMC	L500FCR	P206347	RKRM
IPS4586	M120154	CHLN	K496EXC	P224636	GRMC				L3901414A	P206341	GRMC	L500FNE	P207331	RKRM
			K524BC	J024751	GRMC				L3901414SA	J190013	GRMC	L500FPL	P207346	RKRM
			K524EXA	J024747	GRMC				L400	P206345	RKRM	L500NE	P206349	RKRM
			K524EXC	J024758	GRMC				L40015	P206395	RKRM	L500NE	P206354	RKRM
			K524SBC	J024751	GROCK				L40030	J009632	RKRM	L500SB	P206400	RKRM
			K536EXC	P216204	GRMC				L40030NE	J009636	RKRM	L500SR	P207365	RKRM
			K536SBA	P208374	GRMC				L40045	P206282	RKRM	L50AA	J009607	TORCA
			K536SBC	P208375	GRMC				L40045F	P206282	RKRM	L50BA	P227471	TORCA
			K548EXA	P207296	GRMC				L40045FPL	P206285	RKRM	L50SA	J009624	TORCA
			K548EXC	P207321	GRMC				L40045NE	P207353	RKRM	L510	P207339	RKRM
			K548SBA	P206383	GRMC				L40045SR	P207354	RKRM	L510PL	J009547	RKRM
			K548SBC	P206387	GRMC				L40060	J009640	RKRM	L512	P207339	RKRM
			K560EXC	P207302	GRMC				L40060NE	J009644	RKRM	L512CR	P207339	RKRM
			K560SBA	P208394	GRMC				L400CR	P206345	RKRM	L512NE	P207332	RKRM
			K560SBC	P208395	GRMC				L400F	P206282	RKRM	L512NEPL	J190019	RKRM
			K572EXC	P216205	GRMC				L400FNE	P206346	RKRM	L512PL	J009547	RKRM
			K572SBC	P224600	GRMC				L400FNEPL	J190016	RKRM	L5150404SA	P206396	GRMC
			K584EXC	P224638	GRMC				L400FPL	P207345	RKRM	L5300404A	J009633	GRMC
			K596EXC	P209910	GRMC				L400FS	P206344	RKRM	L5300404SA	J009637	GRMC
			K596SBC	P209912	GRMC				L400FSPL	P207345	RKRM	L5450808A	J190025	GRMC
			KC3015	M065071	VVBCO				L400NE	P207329	RKRM	L5450808C	P206286	GRMC
			KCY238A	J008681	CMWK				L400NECR	J190016	RKRM	L5450808SA	P207354	GRMC
			KCY239A	J009649	CMVVK				L400PL	P206353	RKRM	L5450808SC	P216169	GRMC
			KHH0199	X004476	JCB				L400SB	P206399	RKRM	L5451212A	P206283	GRMC
			KM3103	M085189	RKRM				L400SR	P207364	RKRM	L5601010A	J009641	GRMC
			KPFA015	P224684	KBCO				L401	P206345	RKRM	L5601010SA	J009645	GRMC
			KW14764L	J038611	GRMC				L40AA	J009606	TORCA	L5901010A	J190003	GRMC
			KW14764R	J038612	GRMC				L40BA	P222740	TORCA	L5901010C	J190004	GRMC
			KYX004476	X004476	EIMC				L40SA	J009623	TORCA	L5901010SA	P207365	GRMC
				X004476	DART				L4150404SA	P206395	GRMC	L590101A	J190003	GRMC
				X004476	NFC				L4300404A	J009632	GRMC	L5901212A	P207339	GRMC
				X004476	NFC				L4300404SA	J009636	GRMC	L5901212C	J009547	GRMC
				X004478	DART				L4450909A	P206282	GRMC	L5901212SA	P207332	GRMC
				X004478	DART				L4450909C	P206285	GRMC	L5901515A	P206347	GRMC
				X004478	DART				L4450909SA	P207353	GRMC	L5901515C	P207346	GRMC
				X004480	SLAR				L4451212A	J190023	GRMC	L5901515SA	P207331	GRMC
				X004480	VANAIR				L450F	J190002	RKRM	L5901515SC	J190019	GRMC
				X004480	NFC				L45AA	J190054	TORCA	L5901818A	P206348	GRMC
				X004480	DART				L45SA	J190062	TORCA	L5901818C	P206354	GRMC
				X004480	CNLC				L4600808A	J009640	GRMC	L5901818SA	P206349	GRMC
				X004482	CNLC				L4600808SA	J009644	GRMC	L600	P206350	RKRM
				X004482	PRVT				L46279	M080018	CASE	L60045	P207359	RKRM
				X004482	DART				L488	J008681	RKRM	L600F	P207341	RKRM
				X004482	NFC				L4900606SA	P206399	GRMC	L600FNE	P216175	RKRM
				X004482	VANAIR				L4900808A	J008681	GRMC	L600NE	P216175	RKRM
				X004482	NAVI				L4900808C	P224671	GRMC	L600SB	P207366	RKRM
				X004482	SLAR				L4900808SA	P207364	GRMC	L600SR	P207365	RKRM
				X004482	FRTL				L4901010A	P206344	GRMC	L60AA	J190055	TORCA
				X004482	PRVT				L4901010C	P207345	GRMC	L60BA	P222742	TORCA
				X004482	GRMC				L4901010SA	P207330	GRMC	L60SA	J190063	TORCA
				X004482	GRMC				L4901212SA	P206346	GRMC	L6451515A	P207359	GRMC
				X004482	GRMC				L4901818A	P206345	GRMC	L6451515SA	P207355	GRMC
				X004482	GRMC				L4901818C	P206353	GRMC	L6656	M080018	PETTI
				X004482	GRMC				L4901818SA	P207329	GRMC	L67657	P207362	GEHL
				X004482	GRMC				L4901818SC	J190016	GRMC	L6901313A	P207341	GRMC
				X004484	CRAN									
				X004484	SWEE									

CROSS REFERENCE

Cross Reference

(See first page of this section for Manufacturer's Code Listing)



CROSS REFERENCE

Mfgs. No.	Our No.	Mfg. Code	Mfgs. No.	Our No.	Mfg. Code	Mfgs. No.	Our No.	Mfg. Code	Mfgs. No.	Our No.	Mfg. Code	Mfgs. No.	Our No.	Mfg. Code
L847141	M060232	..PETTI		M070028	..PTBN	M115	M120154	..GRMC	M16307	J009645	..HOIST	M4510	M100695	..PDCI
LA1247	P270538	..PTBN	LN4590	M090781	..PDCI	M11576	P206393	..HOIST	M16323	P206509	..HOIST	M451051	M100695	..PDCI
LA99816	P206344	..PTBN	LN5590	M090074	..PDCI	M117	M120365	..GRMC	M16557	P206508	..HOIST	M45510X15	M120366	..PDCI
LBP5510	M100463	..PDCI	LND5510	M100582	..PDCI	M11997	P206510	..HOIST	M180	M122300	..GRMC	M45511	M110014	..PDCI
LE0201001	M120108	..NPRT	LNS5510	M100580	..PDCI	M11998	M085023	..HOIST	M185	M090563	..GRMC	M4590	M090781	..PDCI
	M120108	..NPLN	LP35095B	M065140	..PTBN	M120186	M120365	..DINA	M1902490	M070069	..ECLD	M4590SP	M090544	..TESSI
LG0203015	P206516	..NPLN	LP501	J009560	..RKRM	M120234	M120235	..CUMS		M070069	..CLRK	M465	M100944	..GRMC
LG503791	M100466	..BADG	LPP00200	P206544	..PTBN	M120450171	M120450	..PACC	M1925199	X004480	..ECLD	M5010	M100465	..RKRM
LG76402	P270539	..BADG	LPP12169	P206405	..PTBN	M121	M120131	..GRMC	M20125	M120100	..ACFT	M503	M120366	..GRMC
LG77619	P206410	..BADG	LPP19262	M085078	..PTBN	M121L	M120450	..GRMC	M20137	M065065	..ACFT	M5090	M090535	..RKRM
LG77625	M100464	..BADG	LPP32697	M085207	..PTBN	M12410	P206336	..HOIST	M20139	M085023	..ACFT	M511	M090548	..GRMC
LG78701	P270541	..BADG	LT350	M070028	..RKRM	M12429	P207326	..HOIST	M20147	M120108	..ACFT	M512	M090520	..GRMC
LI246819	M070069	..PTBN	LT359	M070028	..RKRM	M127	M085171	..GRMC	M20153	M090280	..ACFT	M514	M090781	..GRMC
LL240518	P226132	..PTBN	LT400	M090362	..RKRM	M12967141	H001039	..ECLD	M20183	M085172	..ACFT	M5209443	P207282	..ECLD
	P226144	..PTBN	LT409	M090072	..RKRM	M12969628	M090534	..ECLD	M20185	M090563	..ACFT	M5209756	M090158	..CLRK
LL3690391	P206341	..PTBN	LT509	M090362	..RKRM	M12969629	P206364	..ECLD	M20213	M090538	..ACFT		M090158	..ECLD
LL400	P207338	..RKRM	LVA13826	M001866	..JNDR	M12969630	X007784	..ECLD	M20512	M090520	..ACFT	M525	M085189	..GRMC
LL500	P207340	..RKRM	LVA13827	M001867	..JNDR	M12969930	M090538	..ECLD	M20529	M110189	..ACFT	M526	M100213	..GRMC
LL847117	M085056	..PTBN				M130	M100580	..GRMC	M22260	M060232	..PDCI	M529	M110189	..GRMC
LL847120	M120100	..PTBN	M			M13035	M085411	..HOIST	M2244	M045237	..PDCI	M5294859	X004482	..ECLD
	M120100	..PETTI	M00118	P226148	..HOIST	M13069	J000200	..HOIST	M22525662	M065065	..PDCI	M530	M110112	..GRMC
LL847127	M090158	..PTBN	M001756016210	M001756	..FLPW	M13070	P206340	..HOIST	M23385	M085023	..PDCI	M537	M090547	..GRMC
	M090158	..PETTI	M001867248147	M001867	..FLPW	M131	M090544	..GRMC	M23385X32	M085078	..PDCI	M5384540	P270534	..CLJL
LL847141	M060232	..PTBN	M002117248147	M002117	..DIND	M132	M090074	..GRMC	M235358X11	M090158	..PDCI	M542	M120566	..GRMC
LL847156	M120154	..PETTI	M002122248147	M002122	..GRVE	M13207	J009648	..HOIST	M235385	M085008	..PDCI	M54410	M100049	..PDCI
	M120154	..PTBN	M00369	P206540	..HOIST	M13209	P207353	..HOIST	M23548X11	M090520	..PDCI	M54410X15	M120154	..PDCI
LL847160	M100048	..PTBN	M003691	P206510	..HOIST	M13326	J008681	..HOIST	M24358X11	M090538	..PDCI	M5510	M100465	..PDCI
LL847181	M090146	..PETTI	M101028	P206376	..HOIST	M13327	P206346	..HOIST	M24410	M100048	..PDCI	M5510SP	M100465	..TESSI
LL847245	M090210	..PTBN	M03605	P207326	..HOIST	M13328	P227257	..HOIST	M24410X15	M120100	..PDCI	M5510X67	M100807	..PDCI
LL84726	M070008	..PETTI	M03843	P206511	..HOIST	M13329	P270539	..HOIST	M24411	M110012	..PDCI	M551X67	M100807	..PDCI
LL84729	M070008	..PTBN	M03844	J009429	..HOIST	M13653	P206399	..HOIST	M24411X36	M110189	..PDCI	M55510X15	M120131	..PDCI
	M070008	..PETTI	M03845	M090544	..HOIST	M139	M085023	..GRMC	M2448X11	M090534	..PDCI	M5590	M090535	..PDCI
LL847307	M080024	..PTBN	M0507064	M070008	..VLVO	M144	M090362	..GRMC	M250170	M090538	..RXRD	M595	M090595	..GRMC
LL847322	M070068	..PTBN	M0532603	M070028	..ECLD	M14410	P207318	..HOIST	M2501803	M090170	..VLVO	M6002355	M100048	..MIIN
LL847325	M090362	..PTBN	M060305	P206397	..HOIST	M145	M090072	..GRMC	M2510883	M090159	..ECLD	M6006049	M090072	..ECLD
LL84735	M120100	..PETTI	M06305	P206397	..HOIST	M147	M120108	..GRMC	M2512224	M170101	..VLVO	M6010469	M085056	..ECLD
LL84736	M120100	..PETTI	M06306	P207351	..HOIST	M149	M120382	..GRMC	M2513322	X004484	..ECLD	M669473	P206404	..CLJL
LL84737	M085023	..PETTI	M065072	M065044	..KUTK	M14954	P206410	..HOIST	M2520560	M070068	..ECLD	M70069	M070069	..VMER
	M085023	..PTBN	M06554	M045237	..HOIST	M14958	M090594	..HOIST	M252666	M065071	..PDCI	M724	M110479	..GRMC
LL847372	X007831	..PETTI	M08310	P226144	..HOIST	M150	M070028	..GRMC	M2527050	M120108	..VLVO	M790758	P206406	..CLJL
LL847373	X004480	..PTBN	M085141	M085056	..CUMS	M15035	P206346	..HOIST	M2528407	M090159	..VLVO	M824607	P206405	..CLJL
LL847375	P207281	..PTBN		M085056	..PKNS	M15036	J009644	..HOIST	M2531311	M120189	..VLVO	MA339C	X004480	..ALMD
LL847381	H001284	..PTBN	M085267Q	M085267	..AP	M1512238	M100049	..ECLD	M25510X15	M120108	..PDCI	MAM110014	M110014	..DART
LL847386	X004482	..PTBN	M085411248147	M085411	..BOSS		M100049	..VLVO	M25510X36	M120365	..PDCI	MAN090598	M090598	..DENY
LL847410	P206325	..PTBN	M09002	P207405	..HOIST	M1517515	M090091	..ECLD	M25511	M110077	..PDCI	MB0715	M090091	..WBCO
LL847413	M085207	..PTBN	M090161	M090535	..FLPW	M1518825	M120154	..VLVO	M2A252785	M085172	..PDCI		M090091	..DRSS
LL847414	X004478	..PTBN	M09605	J008671	..HOIST		M120154	..ECLD	M2A25385	M085189	..PDCI	MBT0323479000	H001034	..FRTL
	X004478	..ARDCO	M0M120108	M120108	..KW	M152238	M100049	..CLRK	M2A2748X11	M090563	..PDCI	MBTA0416422000	M120365	..FRTL
LL847427	M090598	..PTBN	M0M120450171	M120450	..KW	M153	M090280	..GRMC	M30510	M090547	..ACFT	MBTA0416704002	M110311	..FRTL
LL847428	X004476	..PTBN	M1000146	M100146	..VLVO	M1543567	M120108	..ECLD	M30511	M090548	..ACFT	MBTA3764920159	P206554	..FRTL
LL847429	M065044	..PTBN	M100582Q	M100582	..AP	M1545546	M090074	..ECLD	M30537	M090547	..ACFT	MBTA3764921340	X007784	..FRTL
LL847430	J190058	..PTBN	M100585	M100580	..FRTL		M090074	..CLRK	M3380	M080018	..PDCI	MBTA3764921940	X007830	..FRTL
LL847437	M090280	..PTBN		M100580	..VLVO	M15456	M085407	..HOIST	M34410X15	M120382	..PDCI	MBTA3764922104	P206311	..FRTL
LL847450	M085056	..PTBN	M10102	M090535	..ACFT	M15467	P206315	..HOIST	M344116X3	M110479	..PDCI	MD820228	X004478	..GM
LL847451	P207362	..PTBN	M10108	M090544	..ACFT	M15469	P206374	..HOIST	M34411X36	M110479	..PDCI	MDM120131	M120131	..KW
LL847458	M101169	..PTBN	M101134	M100580	..MF	M15470	P206386	..HOIST	M34510X15	M120566	..PDCI	ME355M	M065071	..ALMD
LL847462	P207329	..PTBN	M101135	M100582	..MF	M15542	P208389	..HOIST	M34590	M090823	..PDCI	ME421M	M065044	..ALMD
LL847463	M101168	..PTBN	M10127	M085171	..ACFT	M15620	P206512	..HOIST	M353570	M070028	..PDCI	ME423MH	M002118	..ALMD
LL847464	M002121	..PTBN	M10130	M100465	..ACFT	M15660	P206395	..HOIST	M353590	M090146	..PDCI	ME431M	M070028	..ALMD
LL847469	P206849	..PTBN	M10196	M100582	..ACFT	M15661	P206311	..HOIST	M35510	M100213	..PDCI	ME439M	M060158	..ALMD
LL847474	J009648	..PTBN	M102	M090535	..GRMC	M15666	P206543	..HOIST	M3612123	M065044	..KRAM	ME444B	X004536	..ALMD
LL847481	P207338	..PTBN	M10266	P206333	..HOIST	M15677	P206508	..HOIST	M3676064	X004478	..ECLD	ME450MB	M002117	..ALMD
LL847482	M091048	..PTBN	M10514	M090781	..ACFT	M15679	J009486	..HOIST	M4010	M100466	..RKRM	ME454M	M091048	..ALMD
LL847483	M002120	..PTBN	M10531	M100580	..ACFT	M15698	M002120	..HOIST	M4047421	X004484	..ECLD	ME455C	M002120	..ALMD
LL847485	P207352	..PTBN	M106	M090158	..GRMC	M1585116	H001034	..ECLD	M4090	M090544	..RKRM	ME458M	M090595	..ALMD
LL847493	P207402	..PTBN	M10682	M100465	..ACFT	M15877	M100580	..HOIST	M435408X11	M090548	..PDCI	ME459ES	P207298	..ALMD
LL847506	P206544	..PTBN	M10713	M090544	..ACFT	M15883	P207332	..HOIST	M435418X11	M090547	..PDCI	ME460C	J000232	..ALMD
LL84771	M085008	..PTBN	M10739	M090535	..ACFT	M15884	P206396	..HOIST	M4410	M100466	..PDCI	MH0811	P206520	..PDCI
	M085008	..PETTI	M10740	M090781	..ACFT	M15888	P206375	..HOIST	M4410	M100052	..PDCI	MH1000	P206519	..PDCI
LL84786	M045237	..PETTI	M1090074	M090074	..AJMC	M15894	P222759	..HOIST	M4410X15	M120367	..PDCI	MH1015	P206521	..PDCI
LL84788	M065065	..PETTI	M11058	J009636	..HOIST	M1								

Cross Reference

(See first page of this section for Manufacturer's Code Listing)



CROSS REFERENCE

Mfgs. No.	Our No.	Mfg. Code	Mfgs. No.	Our No.	Mfg. Code	Mfgs. No.	Our No.	Mfg. Code	Mfgs. No.	Our No.	Mfg. Code	Mfgs. No.	Our No.	Mfg. Code
R5040A.....	J009649.....	GRMC	RM13093075 ..	J009604.....	IR	S39263.....	M085008 ..	MJPR	SF412.....	J240006.....	GRMC	SPI50084PL....	P224611 ..	RKRM
R6150A.....	P207402.....	GRMC	RM13271606 ..	M091047	IR	S4120SBA.....	P206366 ..	GRMC	SF4120.....	P226146	GRMC	SPI50136PL....	P216227 ..	RKRM
RB35.....	P206409.....	GRMC	RM13861232 ..	P270543	IR	S418EXA.....	P206336 ..	GRMC	SF418.....	P206554	GRMC	SPI50148PL....	P216228 ..	RKRM
RC200.....	P270532	RKRM	RM43846880 ..	M001756	IR	S424EXC.....	P224627 ..	GRMC	SF424.....	J024836.....	GRMC	SP030048PL ..	J540008	RKRM
RC225.....	P270533	GRMC	RM43849355 ..	M002118	IR	S424SBA.....	J240012	GRMC	SF4300.....	P226156	GRMC	SP030024.....	P216191 ..	RKRM
RC250.....	P270534	RKRM	RM43897180 ..	P207596	IR	S436EXA.....	P208364 ..	GRMC	SF436.....	J034673.....	GRMC	SP030036.....	P208324 ..	RKRM
RC275.....	P270535	GRMC	RM43904515 ..	P222744	IR	S436EXC.....	P224628 ..	GRMC	SF512.....	J240007	GRMC	SP030048.....	P207285 ..	RKRM
RC300.....	P270536	RKRM	RM439919646 ..	M090210	IR	S448EXA.....	P207287 ..	GRMC	SF518.....	P226147	GRMC	SP030084PL ..	P207314 ..	RKRM
RC300C.....	P271507.....	GRMC	RM443927623 ..	P206325	IR	S448SBA.....	P206378 ..	GRMC	SF518.....	P206555	GRMC	SP030824.....	P206328 ..	RKRM
RC300PL.....	P271507.....	RKRM	RM46634150 ..	M065073	IR	S448SBC.....	P206388 ..	GRMC	SF524.....	J024838.....	GRMC	SP030836.....	P206376 ..	RKRM
RC350.....	P270538	RKRM	RM4664150 ..	M065073	IR	S460EXA.....	P207288 ..	GRMC	SF524.....	J024838.....	GRMC	SP030836PL ..	P206376 ..	RKRM
RC350C.....	P270536	RKRM	RM59801860 ..	H001039	IR	S460EXC.....	P207299 ..	GRMC	SF5300.....	P226158	GRMC	SP030848.....	P206376 ..	RKRM
RC350C.....	P271508.....	GRMC	RMH10.....	P206519	GRMC	S472SBA.....	J640001 ..	GRMC	SF536.....	J034674.....	GRMC	SP035024.....	J024735 ..	RKRM
RC350PL.....	P271508.....	RKRM	RMH11.....	P224841	GRMC	S48SBA.....	P206364 ..	GRMC	SF6120.....	P226153	GRMC	SP035036.....	P208348 ..	RKRM
RC400.....	P270539	GRMC	RMH85.....	P206517	GRMC	S505881.....	M100048 ..	CASE	SFA1214	P206303	AMC	SP035048.....	P207286 ..	RKRM
RC400C.....	P270837.....	GRMC	RMH9.....	P206518	GRMC	S508420.....	M090158 ..	CASE	SFA4332	P206303	XMN	SP035824.....	P208336 ..	RKRM
RC400PL.....	P270837.....	RKRM	RO430.....	P206321 ..	RKRM	S508699.....	M090170 ..	CASE	SFA5108	P206546	AMC	SP035836.....	P208324 ..	RKRM
RC450.....	P270540	RKRM	RO43075.....	M090158 ..	CASE	S5120SBA.....	P206337 ..	GRMC	SFA8601.....	P206303	XMN	SP035848.....	P206377 ..	RKRM
RC500.....	P270541	RKRM	RO435.....	P206322 ..	RKRM	S518EXA.....	P207283 ..	GRMC	SFA8601.....	P206303	AMC	SP040024.....	J024737 ..	RKRM
RC500C.....	P270838.....	GRMC	RO540.....	P206323 ..	RKRM	S524EXA.....	J024737 ..	GRMC	SFA8601.....	P206303	XMN	SP040036.....	P208364 ..	RKRM
RC500PL.....	P270838.....	RKRM	RO650.....	P207402 ..	RKRM	S524EXC.....	J240024 ..	GRMC	SFA8601.....	P206303	AMC	SP040048.....	P207287 ..	RKRM
RC600.....	P270542	RKRM	S			S524SBA.....	P224589 ..	GRMC	SFSN378.....	J190059.....	AMC	SP040060PL ..	P207288 ..	RKRM
RC600C.....	P270543	RKRM	S0029002.....	M080024 ..	HSTR	S524SBC.....	P224590 ..	GRMC	SFSN378.....	J190059.....	XMN	SP040060PL ..	P207299 ..	RKRM
RC600C.....	P271511	GRMC	S00290020002	M080024 ..	HSTR	S536EXA.....	P208380 ..	GRMC	SI1517.....	M090091	GM	SP040824PL ..	J240012 ..	RKRM
RC600C.....	P270532	RKRM	S0068322.....	P226140 ..	HSTR	S536EXC.....	J340023 ..	GRMC	SI1914.....	M080024	GM	SP040848.....	P206378 ..	RKRM
RC600C.....	P270533	RKRM	S0068525.....	H001278 ..	HSTR	S548EXA.....	P207292 ..	GRMC	SK326022.....	M090158 ..	HSTR	SP040848PL ..	P206388 ..	RKRM
RC600C.....	P270543	RKRM	S008481502.....	M070068 ..	HSTR	S548EXC.....	P207317 ..	GRMC	SKA1710.....	P206512	RKRM	SP040860PL ..	P206390 ..	RKRM
RC600C.....	P271511	GRMC	S008481503.....	P270536 ..	HSTR	S548SBA.....	P206379 ..	GRMC	SKA1740.....	P206508 ..	RKRM	SP040872.....	J640001 ..	RKRM
RC600C.....	P270543	RKRM	S008481505.....	P206600 ..	HSTR	S560EXA.....	P207289 ..	GRMC	SKA1750.....	P206509 ..	RKRM	SP050024.....	J024739 ..	RKRM
RC600C.....	P271511	GRMC	S00848153.....	P270536 ..	HSTR	S560EXC.....	P207300 ..	GRMC	SKA1760.....	P224492 ..	RKRM	SP050024PL ..	J240024 ..	RKRM
RC600C.....	P270532	RKRM	S00848155.....	P206600 ..	NACO	S560SBA.....	P208393 ..	GRMC	SKA1785.....	P206510 ..	RKRM	SP050036.....	P208380 ..	RKRM
RC600C.....	P270533	RKRM	S00848155.....	P206600 ..	HSTR	S560SBC.....	P206391 ..	GRMC	SKA1790.....	P206511 ..	RKRM	SP050036PL ..	J340023 ..	RKRM
RC600C.....	P270543	RKRM	S008706004.....	X004476 ..	NACO	S58SBA.....	P206365 ..	GRMC	SKB800935.....	M060158 ..	GRVE	SP050048.....	P207292 ..	RKRM
RC600C.....	P270543	RKRM	S008706005.....	M065030 ..	NACO	S6120SBA.....	P206338 ..	GRMC	SKB800936.....	M060037 ..	GRVE	SP050048PL ..	P207317 ..	RKRM
RC600C.....	P270543	RKRM	S008706006.....	P270534 ..	NACO	S99911.....	M080024 ..	CASE	SKB830246.....	M070069 ..	GRVE	SP050060.....	P207289 ..	RKRM
RC600C.....	P270543	RKRM	S008850805.....	P270532 ..	NACO	SA150.....	M060038 ..	PDCI	SKB830318.....	M090091 ..	GRVE	SP050060PL ..	P207300 ..	RKRM
RC600C.....	P270543	RKRM	S00933950010	M070068 ..	HSTR	SA200.....	M060037 ..	RKRM	SKC851446.....	M065030 ..	GRVE	SP050848.....	P206379 ..	RKRM
RC600C.....	P270543	RKRM	S00933950010	M070068 ..	HSTR	SA200.....	M060037 ..	PDCI	SKC852108.....	M080024 ..	GRVE	SP050848PL ..	P206389 ..	RKRM
RC600C.....	P270543	RKRM	S00965700030	P206326 ..	NACO	SA2009.....	M060037 ..	RKRM	SKC852117.....	M100048 ..	GRVE	SP050860.....	P208393 ..	RKRM
RC600C.....	P270543	RKRM	S00976760055	M100016 ..	NACO	SA250.....	M065030 ..	PDCI	SKC862037.....	M070069 ..	GRVE	SP050860PL ..	P206391 ..	RKRM
RC600C.....	P270543	RKRM	S00976760056	P207394 ..	NACO	SA250.....	M065030 ..	RKRM	SKS191521.....	M080024 ..	HSTR	SP060048.....	P216197 ..	RKRM
RC600C.....	P270543	RKRM	S00976760058	P271511 ..	NACO	SA2509.....	M065030 ..	RKRM	SKS326022.....	M090158 ..	HSTR	SS53600A.....	M001327 ..	PDCI
RC600C.....	P270543	RKRM	S00977470041	P206365 ..	NACO	SA300.....	M070068 ..	PDCI	SKS477902.....	M060037 ..	HSTR	ST7410136.....	M090538 ..	WHCO
RC600C.....	P270543	RKRM	S010168452.....	M100572 ..	NACO	SA300.....	M070068 ..	RKRM	SKS554702.....	M060037 ..	HSTR	ST95068.....	P206333 ..	CLRK
RC600C.....	P270543	RKRM	S01262720005	P270532 ..	NACO	SA300.....	M070068 ..	HDMI	SKS792071.....	M045193 ..	GRVE	ST95069.....	P206334 ..	CLRK
RC600C.....	P270543	RKRM	S0126272005 ..	P270532 ..	HSTR	SA3009.....	M070068 ..	RKRM	SM4490.....	M090594 ..	PDCI			
RDK8970.....	X004962.....	ROVR	S0126272005 ..	P270532 ..	HSTR	SA350.....	M070069 ..	RKRM	SM5590.....	M090595 ..	PDCI			
RDK9144.....	X004484.....	MULTI	S01351990029	P270533 ..	NACO	SA350.....	M070069 ..	RKRM	SMB.....	P207784	GRMC	T0260.....	P206411 ..	ROSS
RE20223.....	M001432.....	JNDR	S03660.....	P206334 ..	HOIST	SA3509.....	M070069 ..	PDCI	SP030024.....	P216191 ..	RKRM	T0262.....	P270541 ..	ROSS
RE223454.....	X007784.....	JNDR	S03775.....	P206337 ..	HOIST	SA400.....	M080024 ..	PDCI	SP13SS.....	P206543 ..	RKRM	T0263.....	M100463 ..	ROSS
RE223455.....	X007785.....	JNDR	S099911.....	M080024 ..	CASE	SA400.....	M080024 ..	HDMI	SP1410AL.....	P206542 ..	RKRM	T0411.....	M090535 ..	ROSS
RE35655.....	X007830.....	JNDR	S11732.....	M060005 ..	LEC	SA400.....	M080024 ..	HDMI	SP1410SS.....	X005207 ..	RKRM	T0936444.....	J000203 ..	CAME
RE42815.....	X007784.....	JNDR	S1671B.....	J190059.....	SOFI	SA4009.....	M080024 ..	RKRM	SP1485AL.....	P206540 ..	RKRM	T120287.....	P206342 ..	MRMT
RE42816.....	X007785.....	JNDR	S209070.....	M080018 ..	MJPR	SA408.....	M080024 ..	RKRM	SP1485SS.....	X005207 ..	RKRM	T120289.....	P206344 ..	MRMT
RE52768.....	M001668.....	JNDR	S219802.....	M065034 ..	CASE	SA408.....	M080024 ..	RKRM	SP1490AL.....	P206540 ..	RKRM	T13762.....	M070008 ..	PH
RH049688.....	M060005.....	DRSS	S220817.....	M085023 ..	CASE	SA408.....	M080024 ..	RKRM	SP1490SS.....	X005207 ..	RKRM	T1407.....	P206315 ..	ROSS
RH100260.....	X004484.....	OKSH	S222578.....	M120154 ..	CASE	SA500.....	M090091 ..	PDCI	SP14SS.....	X005207 ..	RKRM	T1408.....	P206340 ..	ROSS
RH49688.....	M060005.....	GALN	S224620.....	M090210 ..	MJPR	SA500.....	M090091 ..	RKRM	SP18.....	P206543 ..	RKRM	T1409.....	P206408 ..	ROSS
RI250.....	P207382.....	RKRM	S226198.....	M070069 ..	CASE	SA5009.....	M090091 ..	RKRM	SP1836SS.....	P206543 ..	RKRM	T1411.....	P206353 ..	ROSS
RI275.....	P207385.....	RKRM	S228668.....	M120189 ..	CASE	SA600.....	M100016 ..	PDCI	SP18SS.....	P206543 ..	RKRM	T1412.....	P270837 ..	ROSS
RI350.....	P206313.....	RKRM	S228672.....	M090091 ..	CASE	SA6009.....	M100016 ..	RKRM	SP19SS.....	P206543 ..	RKRM	T1430.....	P206336 ..	ROSS
RI353.....	P206314.....	RKRM	S230848.....	M060232 ..	CASE	SC015041039	H001039 ..	URIG	SP200A.....	P206331 ..	PDCI	T200.....	P206403 ..	AP
RI375.....	P207386.....	RKRM	S231674.....	M090301 ..	CASE	SC015042039	H001039 ..	URIG	SP250A.....	P206333 ..	PDCI	T212.....	P206405 ..	AP
RI430.....	P206315.....	RKRM	S237009.....	M100146 ..	CASE	SC015042057	P270543 ..	URIG	SP275A.....	J000127.....	PDCI	T214.....	P206404 ..	AP
RI435.....	P206316.....	RKRM	S226198.....	M070069 ..	CASE	SD53453.....	P226151 ..	PIE	SP5201.....	M120100 ..	WBICO	T234.....	P206406 ..	AP
RI540.....	P206317.....	RKRM	S228668.....	M120189 ..	CASE	SF3120.....	P226144 ..	GRMC	SPA1485PL.....	P206510 ..	RKRM	T2340474.....	P270539 ..	CASE
RI650.....	P206318.....	RKRM	S228672.....	M090091 ..	CASE	SF3300.....	P226132 ..	GRMC	SPA1710PL.....	P206512 ..	RKRM		P270539 ..	PTN
RI650PL.....	P206318.....	RKRM	S230848.....	M060232 ..	CASE	SF35120.....	P226145 ..	GRMC	SPA1750PL.....	P206509 ..	RKRM	T300.....	P206407 ..	TRUX
RJ430.....	J009648.....	RKRM	S231674.....	M090301 ..	CASE	SF3518.....	P206553 ..	GRMC	SPA1790PL.....	P206511 ..	RKRM		P206407 ..	AP
RJ540.....	J009649.....	RKRM												

(See first page of this section for Manufacturer's Code Listing)

Mfgs. No.	Our No.	Mfg. Code	Mfgs. No.	Our No.	Mfg. Code	Mfgs. No.	Our No.	Mfg. Code	Mfgs. No.	Our No.	Mfg. Code	Mfgs. No.	Our No.	Mfg. Code
T303602	M100572	COUG	TEC400	J000216	RKRM	UA500	J000232	RKRM	VB588C	P206607	GRMC	X14152005	M085090	ISZU
T303710	P206849	COUG	TEC450	J000219	RKRM	UA600	J000233	RKRM	VF140V	P206546	VLVO	X141520050	M085090	SRC
T304402	P206851	COUG	TEC500	J000217	RKRM	UAF300	P206600	RKRM	VP0644	M090009	FRHF	X14152007	P270536	ISZU
T312	P206409	AP	TEC600	J000218	RKRM	UAF300PL	P206608	RKRM	VP0673	M070008	FRHF	X141520070	P270536	SRC
	P206409	TRUX	TEL40090	P206344	TAC	UAF350	P206601	RKRM	VP19332	X004482	FRHF	X14152014	P270531	ISZU
T312Z	P206409	TRUX	TFC200	X004536	RKRM	UAF350PL	P206609	RKRM	VP20093	M120154	FAST	X141520140	P270531	ISZU
T314	P206408	TRUX	TFC225	X004537	RKRM	UAF400	P206602	RKRM		M120154	FRHF		P270531	SRC
	P206408	AP	TFC250	X004476	RKRM	UAF400PL	P206610	RKRM	VP20096	M120197	FRHF	X14152019	M065034	ISZU
T3626ID	P207619	GRMC	TFC275	X004538	RKRM	UAF500	P206603	RKRM		M120197	FAST	X14152022	M065044	ISZU
T378801	M060055	HSTR	TFC300	X004478	RKRM	UAF500PL	P206611	RKRM	VP20097	M120365	PLOC	X141520220	M065044	SRC
T384786	M065034	HSTR	TFC350	X004480	RKRM	UAF600	P207596	RKRM	VP20098	M070068	FRHF	X14152023	P207324	ISZU
T400	P205979	RKRM	TFC400	X004482	RKRM	UAF600PL	P207598	RKRM	VP644	M090009	FAST	X141520230	P207324	SRC
	P206410	TRUX	TFC500	X004484	RKRM	UF300PL	P206608	RKRM	VP673	M070008	FAST	X14152024	P270534	ISZU
	P206410	AP	TFC600	X004539	RKRM	UF400	P206602	RKRM	VT71457	M060037	UAC	X141520240	P270534	SRC
T400Z	P206410	TRUX	TFS400	X007784	RKRM	UF400PL	P206610	RKRM	VY6771	M085056	WBICO		P270534	ISZU
T412Z	J000231	TRUX	TFS500	X007785	RKRM	UF500	P206603	RKRM				X14152027	M090301	ISZU
T4256ID	P207581	GRMC	TJ700293000	P206340	PTBN	UF500PL	P206611	RKRM				X141520270	M090301	SRC
T4756ID	P207620	GRMC	TJ841074700	X007831	PTBN	UF600PL	P207598	RKRM	W0M090159	M090159	FRAM	X14152028	P206342	ISZU
T50	M045237	COMP	TJ841076000	X004478	PTBN	UH100	P206507	RKRM	W2440435	P270538	CASE	X141520280	P206342	SRC
T500	P206299	RKRM	TJF122164	J000202	PTBN		P206507	PDCI		P270538	PTN	X14152029	P270538	ISZU
	P206411	AP	TOHD2427	M070069	SCRM	UH340	P270543	RKRM	WFC3	X007830	GRMC	X141520290	P270538	SRC
	P206411	TRUX	TP4001015	M120100	TAC	UH450	P207784	RKRM	WFC4	X007784	GRMC	X14152030	P206409	ISZU
T500Z	P206411	TRUX	TP8275240	J009618	PTBN	UT46661	M090158	UAC	WFC4A	X007824	GRMC	X141520300	P206409	SRC
T5XA601M	M085208	COUG	TSC400	X007784	RKRM	UV250	P206606	RKRM	WFC5	X007785	GRMC	X141520300	P270539	SRC
T5XA605M	P270536	COUG	TSC500	X007785	RKRM	UV277	J009618	RKRM	WFC5A	X007805	GRMC	X141520430	P270539	ISZU
T5XB601M	M085208	COUG	TTA300	X007833	RKRM	UV300	P206604	RKRM	WM26002	M070069	TDSC	X141520480	P270532	SRC
T600	P207667	TRUX	TTA350	X007834	RKRM	UV350	P206605	RKRM	WR125158	M001702	AGCO	X150	P222748	MRMT
	P207667	AP	TTA400	X007824	RKRM	UV400	P206606	RKRM	WR125159	M085409	AGCO	X1750597	H001279	PTN
T600Z	P207667	TRUX	TTA500	X007805	RKRM	UV401	J009614	RKRM	WR125161	P206380	AGCO		H001279	CASE
TAA400	J000202	RKRM	TTA600	J190055	RKRM	UV478	P206605	RKRM	WR128453	M002119	AGCO	X205	X004536	MRMT
TAC360	M090680	TAC	TTS200	J190056	RKRM	UV500	P206607	RKRM	WR24908	M080018	AGCO	X230	X004537	MRMT
TAC370	M085172	TAC	TTS225	J190057	RKRM	UV501	P206607	RKRM	WR28656	X004482	AGCO	X2440436	M070069	CASE
TAC400BB	M090544	TAC	TTS250	X007829	RKRM				WR28658	P207297	AGCO		M070069	PTN
TAC427	M090146	TAC	TTS275	J190059	RKRM				WR32441	P206321	AGCO	X255	X004476	MRMT
TAC466	M090520	TAC	TTS300	X007830	RKRM	V1091149	X006202	VLVO	WR32821	X004478	AGCO	X270	J009612	MRMT
TAC800	M090280	TAC	TTS350	X007831	RKRM	V111111	M090535	VLVO	WR34818	M065044	AGCO	X275	J000224	MRMT
TAC800L	M090534	TAC	TTS400	X007784	RKRM	V1111110	M100465	VLVO	WR34821	J240004	AGCO	X280	X004538	MRMT
TAC801	M110189	TAC	TTS450	X007785	RKRM	V1111111	M090544	VLVO	WR37234	J014623	AGCO	X295	J009611	MRMT
TAC900	M090563	TAC	TTS500	X007785	RKRM	V1111112	M090535	VLVO		P206311	AGEM	X300	J000227	MRMT
TBA350	X006204	RKRM	TTS600	X009076	RKRM	V1111113	M090535	VLVO	WR37235	P206311	WILM	X305	X004478	MRMT
TBA4	P205976	GRMC				V1111112	M100464	VLVO		M100048	AGCO	X350	J000228	MRMT
TBA400	X006203	RKRM	U			V1111114	M100464	VLVO	WT200	P206331	RKRM	X355	X006204	MRMT
TBA5	P206300	GRMC	U112	P222748	AP	V1114917	M100463	VLVO	WT200CR	P206331	RKRM	X370	P206605	MRMT
TBA500	X006202	RKRM	U200	P206403	RKRM	V1116639	M100213	VLVO	WT250	P206333	RKRM	X400	J000230	MRMT
TBB61240011	M110674	FRTL		P206403	TRUX	V1119466	X006203	VLVO	WT250CR	P206333	RKRM	X405	X006203	MRMT
TBB61240169	M120713	FRTL	U200Z	P206403	RKRM	V6772734	X004480	VLVO	WT275CR	J000127	RKRM	X505	X006202	MRMT
TBE4	P205979	GRMC	U212	P206405	TRUX	V8056009	M100465	VLVO	WT300	P206334	RKRM	X5103064	M090091	GRDL
TBE5	P206299	GRMC	U214	P206404	TRUX	V8056472	X004962	VLVO	WT300CR	P206334	RKRM	X5103066	J009649	GRDL
TBS400	X007784	RKRM	U225	P206404	RKRM	V98HA5225AA	M100580	MERS	WT350	P206335	RKRM	X5103067	J009637	GRDL
TBS500	X007785	RKRM	U250	P206405	RKRM	VA21040004A	P270538	GRDL	WT350CR	P206335	RKRM	X5103068	J024750	GRDL
TCBH084	M070028	PTBN	U250Z	P206405	RKRM	VA21040034A	P270541	GRDL	WT400	P206336	RKRM	X8821116	P206605	LIBB
TCBH087	P206507	PTBN	U275	P206406	RKRM	VA21270018A	P206409	GRDL	WT400CR	P206336	RKRM	XA58300	M070028	CASE
TCBH135	M070325	PTBN	U275Z	P206406	RKRM	VA22750032	P206397	GRDL	WT500	P206337	RKRM	XD200	J000220	MRMT
TD001	M065065	MRMT	U300	P206407	RKRM	VA22750032A	P206397	GRDL	WT600	P206338	RKRM	XD225	J000222	MRMT
TD002	M085023	MRMT	U300PL	P206407	RKRM	VA22750033A	P206372	GRDL	WT600CR	P206338	RKRM	XD250	J000221	MRMT
TD017	M090535	MRMT	U300Z	P206407	RKRM	VA22750563	P206340	GRDL	WTM100104	M100464	DART	XD275	J000224	MRMT
TD019	M085008	MRMT	U325	P206408	RKRM	VA22599014	M090210	GRDL	WZM100464	M100464	FRTL	XD350	M085008	RKRM
TD022	M060232	MRMT	U325Z	P206408	RKRM	VA25990015	M090210	GRDL		M100464	DART	XD355	M085008	RKRM
TD1	M065065	MRMT	U350	P206409	RKRM	VA34160003	P270541	GRDL				XD4019	M100049	RKRM
TD17	M090535	MRMT	U350PL	P206408	RKRM	VA34200021	P207596	GRDL	X004482016147	X004482	AJMC	XD415	M090594	RKRM
TD19	M085008	MRMT	U350Z	P206409	RKRM	VA34240209	P206543	GRDL	X005164	X007831	TIPP	XD514	M085171	RKRM
TD2	M085023	MRMT	U400	P206410	RKRM	VA34240210	P206508	GRDL	X005265	X007829	SCRIM	XH4M2	M090680	NFC
TD22	M060232	MRMT	U400PL	J009486	RKRM	VA34240339	P206508	GRDL	X1034633	M060055	ELGN	XH4MD1	M090563	NFC
	M060232	MARE	U450Z	J000231	RKRM				X12209	M0600247	RKRM	XSC212	X004476	NFC
TDA400	P206304	TAC	U500	P206411	RKRM	VA48950705A	P206372	GRDL	X12259	M060005	RKRM	XSC214	X004537	NFC
TE840001	M080024	TREX	U500PL	J009487	RKRM	VA48951215	P206379	GRDL	X1230	M070008	RKRM	XSC234	X004538	NFC
TEC200	J000210	RKRM	U500Z	P206411	RKRM	VA601343	P206325	GRDL	X12309	M070008	RKRM	XSC312	X004480	NFC
TEC225	J000212	RKRM	U600	P207667	RKRM	VA602286	M070028	GRDL	X12359	M070050	RKRM	XSC4	X004482	NFC
TEC250	J000211	RKRM	UA300	J000227	RKRM	VA604749	J024735	GRDL	X12409	M090009	RKRM	XX0070722	P207332	SABI
TEC275	J000213	RKRM	UA350	J000228	RKRM	VB475C	P222018	GRMC	X14152004	P270531	ISZU	XX0070724	J024838	SABI
TEC300	J000214	RKRM	UA400	J000230	RKRM	VB475D	P206606	GRMC						
TEC350	J000215	RKRM												

Cross Reference

(See first page of this section for Manufacturer's Code Listing)



CROSS REFERENCE

Mfgs. No.	Our No.	Mfg. Code	Mfgs. No.	Our No.	Mfg. Code	Mfgs. No.	Our No.	Mfg. Code	Mfgs. No.	Our No.	Mfg. Code	Mfgs. No.	Our No.	Mfg. Code
XX0071216	X004484	SABI										
Y														
Y05667000	X004482	FDEN										
Y05667111	X004484	FDEN										
Y0602300162	..	M085208	DENY										
Y0602300395	..	M090598	DENY										
Y0602325066	..	M001432	DENY										
Y0602325088	..	X004476	DENY										
Y0602325089	..	X004478	DENY										
Y0602325097	..	X004536	DENY										
Y400	P206297	RKRM										
Y401NPA	P206297	GRMC										
Y500	P206298	RKRM										
Y500NPA	P206298	GRMC										
YB400A	J092679	GRMC										
YB500A	J092689	GRMC										
YS400	J092679	RKRM										
YS500	J092689	RKRM										
Z														
Z1540470	P270541	CASE										
		P270541	PTN										
Z1750597	H001279	CASE										
		H001279	PTN										
Z3036919	X004478	PTN										
		X004478	CASE										
ZDNP206336	..	P206336	NAVI										
ZF305	M060037	..	MRMT										
ZF306	M065030	..	MRMT										
ZF307	M070068	..	MRMT										
ZF308	M070069	..	MRMT										
ZF604	M080024	..	MRMT										
ZF605	M090091	..	MRMT										
ZF606	M090072	..	MRMT										
ZF615	M085172	..	MRMT										
ZF665	M085267	..	MRMT										
ZF855	M120100	..	MARE										
		M120100	..	MRMT										
ZF860	M090538	..	MRMT										
ZF868	M090280	..	MRMT										
ZF869	M090563	..	MARE										
		M090563	..	MRMT										
ZF895	M110012	..	MRMT										
ZF917	M090534	..	MRMT										
ZF947	M090520	..	MRMT										
ZF955	M090547	..	MRMT										
ZF956	M120154	..	MRMT										
ZH002	M120365	..	MRMT										
ZH003	M120197	..	MRMT										
ZH012	M110189	..	MRMT										
ZH201	M100464	..	MARE										
		M100464	..	MRMT										
ZH202	M090544	..	MRMT										
ZH203	M090544	..	MRMT										
ZH206	M090535	..	MRMT										
ZH209	M090146	..	MRMT										
ZZ8002001	P206400	NPRT										
		P206400	NEPN										

Shoptalk - Free Subscription!

www.shoptalk.donaldson.com

Maintenance tips, cost reduction ideas and product features and benefits from the filtration and emissions experts - simple facts every diesel owner can use!

Topics are presented by industries so you can easily find information relevant to your business.

Join the thousands of other vehicle owners who have signed up for our Shoptalk e-newsletter.

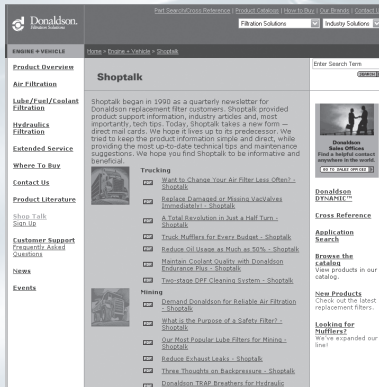

Section Index

- Shoptalk - Free Subscription!161
- Purpose of an Exhaust System.....162
- Muffler Design & Performance162
- Exhaust Product Materials.....163
- Noise Sources164
- Truck Noise Control.....165
- Rules of Thumb.....166
- Emissions Devices & Acoustic Silencing.....166
- Familiar Sounds on the dBA Noise Scale 166
- Emissions Mandates & Timing166
- Diesel Particulate Matter (PM) Allowed per Horsepower-Hour (soot vials)167
- Cutting & Installation Instructions for Flex Tubing.....168
- Donaldson & Industry Acronyms.....169
- Engine Brake & Exhaust Silencer169
- SealClamp™ Installation Instructions Flat Band Style.....170
- Stepped Preformed Style171
- Terms & Definitions172

Purpose of an Exhaust System

Exhaust system design specifications are typically defined by the OEs. They are looking for a solutions that can redirect engine exhaust, reduce exhaust noise and most recently, reduce emissions (hydrocarbons, carbon monoxide, soluble organic fraction (SOF)).

Diesel engines are a reliable and efficient power source for vehicle and equipment manufacturers. Governmental regulations across the globe are driving diesel engine users to consider buying new vehicles or retrofitting their existing engines to meet the new emissions regulations.

Muffler Design & Performance

Donaldson mufflers are designed and tested with specific focus on three performance variables: attenuation, backpressure and structural.

Attenuation

For exhaust systems, attenuation refers to the reduction in sound level measured between an engine without a muffler and the same engine with a muffler. This sound level is typically measured in a decibal scale (dBAs). Traditional mufflers use tubes, baffles, and expansion chambers and insulation to help control noise. Newer applications include emissions reduction devices installed in the exhaust system. Many of the devices also provide the needed noise attenuation either in part or in total.

Sound quality is an additional noise characteristic that is important to the end user. An example of a sound quality concern is the sound of fingernails on a chalk board – this screeching sound makes people wince, yet the measured sound level would not be significant. A low throaty rumble may seem even quiet (and almost desirable) but may be amplified and become annoying if it reverberates within the operator's cabin.

Heavy-duty mufflers typically employ one of four sound reduction techniques including:

Reactive silencing

What's important: the ratio of the body diameter to the tube

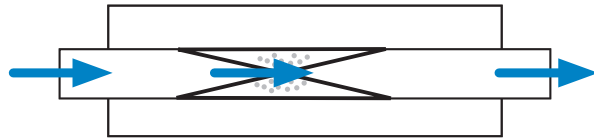

Resistive silencing

Exhaust flow is forced through a small area. It removes energy to reduce noise level.

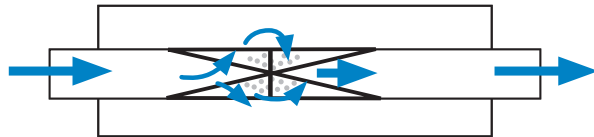

Absorptive silencing

Transforms wave energy into thermal energy. Uses acoustic packing (or wrap) just inside the outer shell of the muffler.

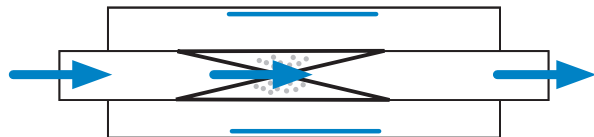

Engine manufacturers generally expect a reduction in engine exhaust sound level of 15-25 dBA. The overall noise level of a vehicle or piece of stationary equipment is the actual regulated value. The overall noise level is typically measured while driving past a microphone at a specific speed and distance. Maximum noise levels in the U.S. are regulated by the U.S. EPA (Environmental Protection Agency).

Backpressure

A key performance factor in selecting the proper muffler is backpressure. For the most efficient engine performance it is important to apply a muffler that minimizes backpressure.

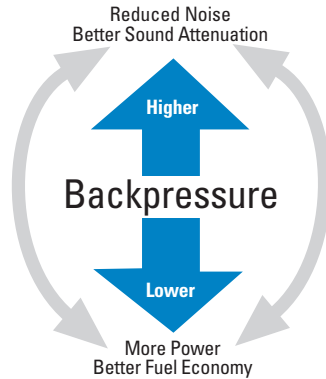

Backpressure is the force necessary to flow gasses through the Exhaust system, or the resistance to exhaust flow. System considerations include friction and momentum effects - expansion / contraction / elbows, and velocity head loss at outlet.

To minimize backpressure, long tube lengths, small tube diameters, and sudden contractions should be avoided.

Backpressure can reduce horsepower and fuel economy. For example, turbocharged diesel engines lose about 0.5% in horsepower and fuel economy per inch Hg backpressure. To help you minimize backpressure, our selection guide provides exhaust flow ratings at 1", 2" and 3" Hg (mercury).

Conversion: 1.0" Hg = 13.6" H₂O

Our muffler spec'ing section outlines the steps you need to take for proper muffler selection.

Structural

Another performance factor is the structural durability of the system configuration. Position, mounting support, weight and the type of material that the unit is made from are the key sub-components of system structure.

For example, the original OE stanchion or chassis mounting components are adequate for a replacement muffler. If you apply a heavier muffler, like one with an emissions device inside, it's critical to upgrade the hangers, brackets and stanchion with more robust and heavier components. Most exhaust system problems encountered by Donaldson field service are due to improper bracketing and/or use of clamps – not the muffler or muffler construction.

Exhaust Product Materials

There are a number of materials found in diesel exhaust applications. Some of the materials are appropriate for heavy duty applications and have the mechanical properties to provide good service life.

Since materials vary in strength, corrosion resistance, and price, a particular material may be preferred in individual applications and components. Some of the most common materials, their qualities, and their typical uses are listed in the following table.

Materials*	Used in	Qualities
Aluminized Mild Steel	Mufflers	Good Corrosion Resistance
	Exhaust Components	
Stainless Steel (with and without aluminized coating)	Flexible Tubing	Stronger Excellent Corrosion Resistance
	Mufflers	
	Exhaust components	
	Emissions Products	
Chrome	Accessories	Bright Mirror Finish
Galvanized	Flexible Tubing	Low Material Cost Temperature Limit 600°F
Cold Rolled	Accessories	Poor Corrosion Resistance Low Cost

Aluminized steel is the preferred material for traditional diesel exhaust applications. Aluminized steel is a low carbon steel with a thin layer of aluminum alloyed to the surface. The aluminum provides a barrier for protection of the base material. Aluminized steel parts have an ultimate service temperature of 1250°F with a continuous duty temperature limit of 1000°F. This material closely matches the expected service temperatures of diesel engine applications and has excellent corrosion resistance to acidic diesel exhaust gases. Aluminized steel parts provide good field life at a reasonable cost.

Series 400 stainless steels are used for many extended service life diesel applications, and often in gasoline applications due to their higher operating temperatures. This material family provides slightly better strength at exhaust system temperatures than aluminized steel.

Type 409 is the most common 400 series stainless

steel used in exhaust applications. Type 409 is stronger than aluminized but exhibits cosmetic problems at exhaust system temperature. At first exposure to high temperature it discolors. Over time it develops a nondestructive coating of surface rust. After an extended time in the field a 409 product will display external discoloration and look worse than a similar part made from aluminized steel, but will last much longer.

Another choice is 409 stainless steel with an aluminum coating. Aluminized 409 is used on diesel catalytic converter mufflers due to its excellent high temperature resistance and the corrosion protection of the aluminized coating. Aluminized 409 is found primarily on emission products or high temperature gasoline applications.

Series 300 stainless steels are also utilized in exhaust systems. The most common material is Type 304. This material has excellent corrosion resistance and very good high temperature strength and is used in some muffler applications where very high stresses occur. This is a premium material and is also used in many for gasoline applications. The most prevalent use of the material in heavy duty diesel applications is for flex pipe. Flex pipe produced from light gauge 304 stainless steel is an excellent choice considering all the factors of cost, durability, and service life.

Often chrome plated cold rolled steel parts are found on exhaust system parts. This material is a reasonable choice for cosmetic applications where a bright mirror finish is desired. Corrosion from the inside of the product can still occur. Chrome parts may be very challenging to produce. It is important to produce the parts with a high level of quality because surface irregularities are very visible to the end user.

An alternate choice for chrome parts is bright annealed stainless steel. This material provides a bright mirror like finish with excellent exhaust service life. Bright stainless steel is typically used for muffler heat shields and generally an expensive material choice.

Noise Sources

Five Major Sources of Noise in Trucks

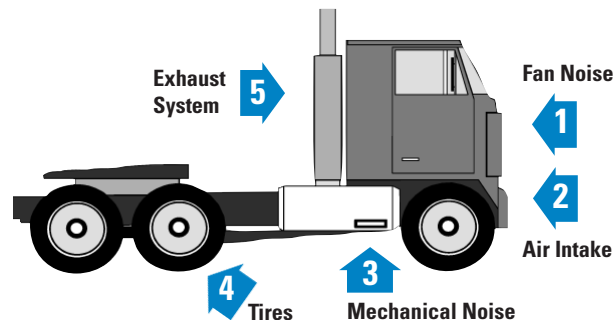

Easy Maintenance Tips Reduce Exhaust Noise

- 1 Check the exhaust tubing. Repair or replace worn or leaking components.
- 2 Make sure your exhaust system is properly supported.
- 3 Installing a resonator or wye connector muffler is an economical way to reduce noise.
- 4 Modify a single exhaust system to a dual.
- 5 Check stack and tailpipe position. A straight stack will be quieter than a curved stack on vertical exhaust systems. Turn your horizontal tailpipes toward the center of the road.

Truck Noise Control

(from U.S. EPA Web site)

In the past, the Environmental Protection Agency (EPA) coordinated all federal noise control activities through its Office of Noise Abatement and Control. However, In 1981, the Administration at that time concluded that noise issues were best handled at the State or local government level. As a result, the EPA phased out the office's funding in 1982 as part of a shift in federal noise control policy to transfer the primary responsibility of regulating noise to state and local governments. However, the Noise Control Act of 1972 and the Quiet Communities Act of 1978 were not rescinded by Congress and remain in effect today, although essentially unfunded. View more information about resources on noise pollution.

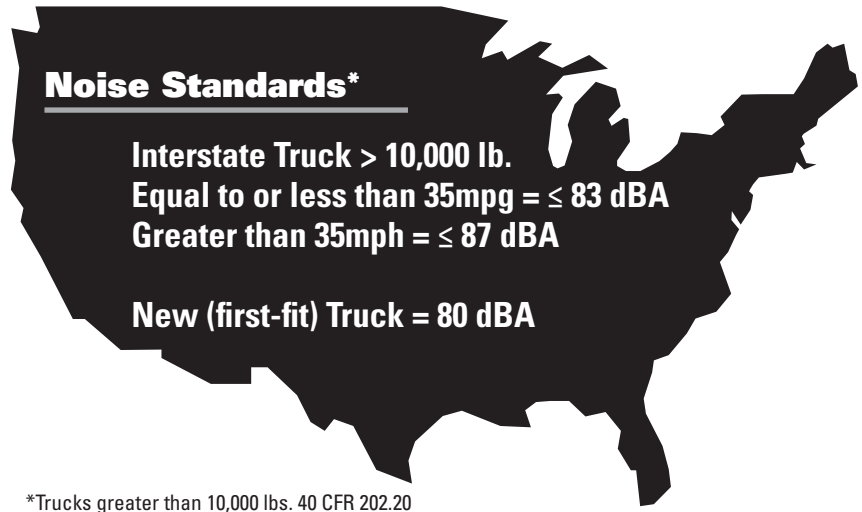

*Trucks greater than 10,000 lbs. 40 CFR 202.20

** Noise is measured at 50 feet (15.2 m) from the centerline of the lane of travel

Interstate Motor Carrier Noise

The Federal Highway Administration's Office of Motor Carrier and Highway Safety Web site includes information on the Interstate Motor Carrier Noise Emission Compliance Regulations from the Code of Federal Regulations (49 CFR 325)

Subparts for compliance of the interstate motor carrier noise emission standards
http://www.fmcsa.dot.gov/rules-regulations/administration/fmcsr/fmcsrguidedetails.aspx?rule_toc=730§ion_toc=730

Part	Regulation
Subpart A	General Provisions
Subpart B	Administrative provisions
Subpart C	Instrumentation
Subpart D	Measurement of noise emissions; highway operations
Subpart E	Measurement of noise emissions; stationary test
Subpart F	Correction factors
Subpart G	Exhaust systems and tires

Rules of Thumb

Combining Two Equal Noise Sources Increases Sound Level by 3 dBA

Two equal noise sources combine to create a sound level 3 dBA greater than either source.

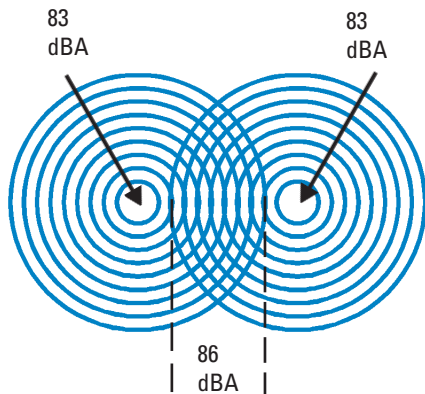

Twice the Loudness is a 10 dBA Increase

The increases are not linear! Increasing noise by 10 dB sounds twice as loud.

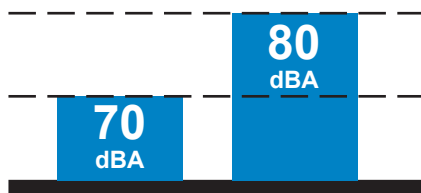

Sound Pressure Level Changes With Distance

Doubling the distance to a noise source decreases its sound level by 6 dB. Halving the distance to a noise source increases its sound level by 6 dB.

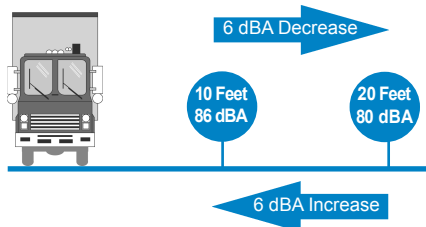

Emissions Devices & Acoustic Silencing

Various emissions reduction technologies are applied to exhaust systems to meet new emissions standards. The additional components can significantly change or eliminate the traditional acoustic silencing components common in older muffler designs. Depending on the application, emissions reduction devices may totally eliminate the need for further sound control and for others, minimal acoustic silencing may be required. The sound attenuation of emissions devices varies depending on the filtering substrates and configuration of the overall system.



Typical emissions aftertreatment substrates (ceramic and metal)

Familiar Sounds on the dBA Noise Scale

Other examples of sound levels:

70 dB Traffic jam; 90 dB Heavy machinery, 130 dB Jet engine at 10 meters.

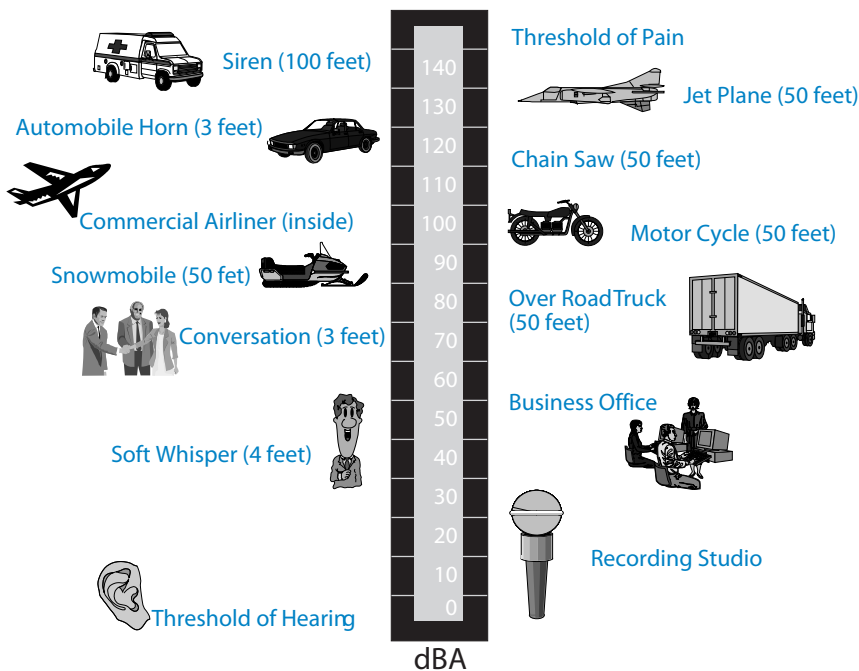

Diesel Particulate Matter (PM) Allowed per Horsepower-Hour

What does "Diesel PM per Horsepower-Hour" Mean?

A 200 horsepower (HP) engine could release as much as 200 times the amount shown in one vial during one hour of operation or a 300 HP engine could release as much as 300 times the amount shown in one vial during one hour of operation.

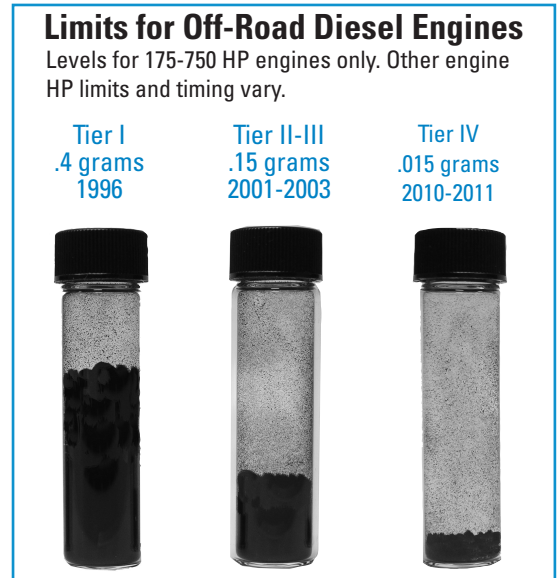
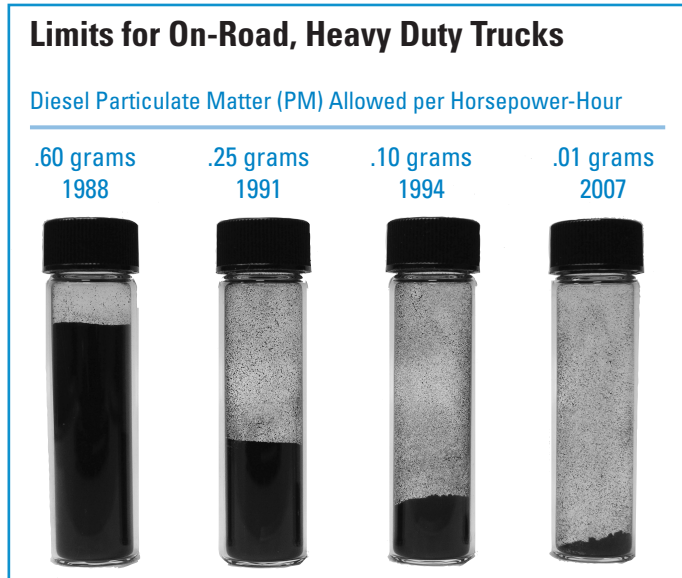

Soot vials are shown smaller than actual size (2-3/8" height).

Worldwide Emissions Mandates & Timing

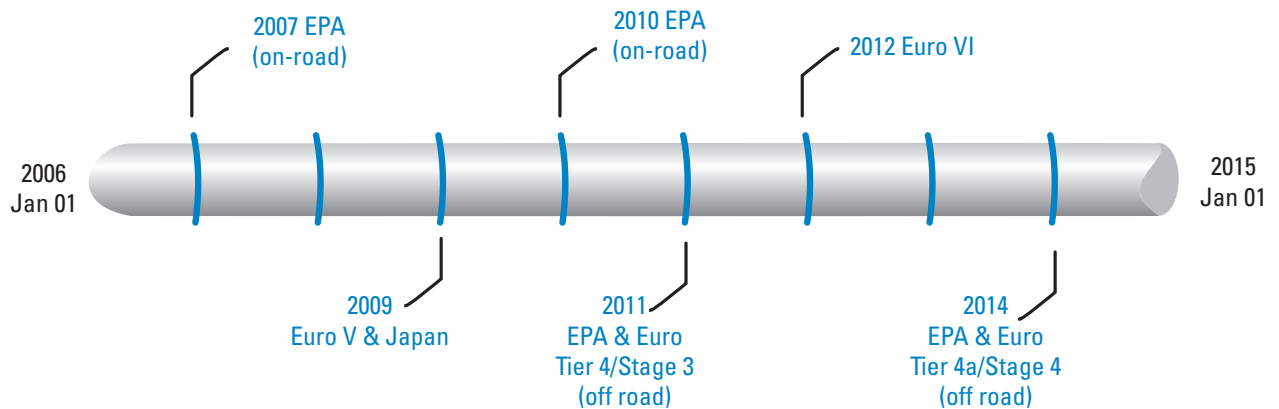

Flexible tubing can twist or unravel when cut, causing its diameter to change and making installation difficult. This occurs because flexible tubing must maintain flexibility in order to function properly, and, therefore, cannot be tightly wound in the manufacturing process. However, flexible tubing can be managed for trouble-free installation by following these guidelines.



Cutting

Step 1 - Prepare

Place a tack weld between convolutions on each side of the intended cut to keep ends from twisting or unraveling.

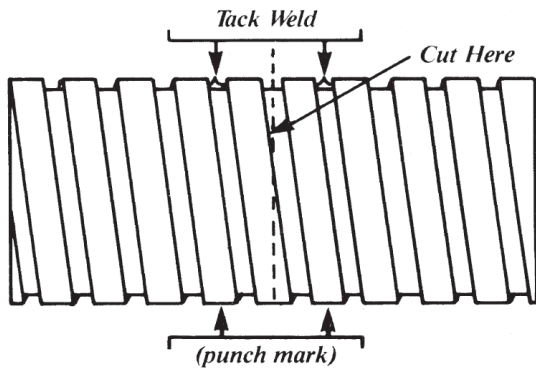

If a welder is not available, insert a mandrel or back-up pipe into the tubing and place a punch mark directly on convolutions on each side of the intended cut. Heavy-duty tape over a de-greased pair also works. Cut through tape and leave in place, clamp over tape.

Step 2 - Cut

Place the tubing securely in a vice. Cut with a metal cutting band saw or a hacksaw with 32 teeth per inch.

Step 3 - Trim

Each side of the cut will now have a spiral "tail" that must be removed to the point at which it is attached. Bend each tail until it breaks, or bend and use a cutting shears to remove.

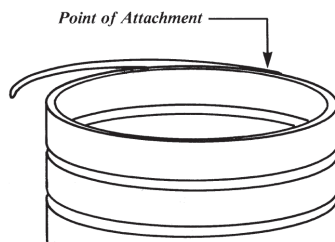

Step 4 - Deburr

Deburr both cut surfaces with a hand-operated drum sander or file.

Installation

Flexible tubing's function is to prevent excessive stress on exhaust system components by absorbing vibration and thermal expansion that would otherwise cause system components to shake loose and break.

To provide adequate flexibility, flex tubing should be installed in a half extended state. To reach half extension, place the middle of the tubing over the edge of a work bench, push down on both halves and bend as much as possible.

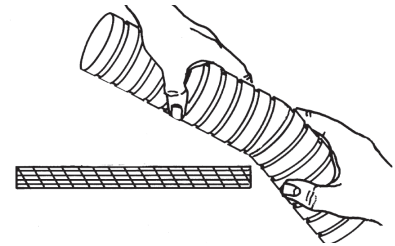

Then place the entire piece of tubing on the work bench and push the end down until straightened. The tubing is now at half extension.

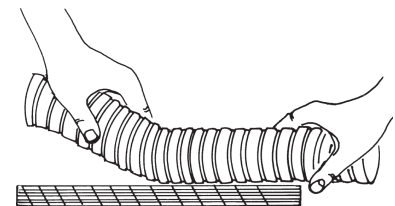

Note: Do not use flexible tubing to form an exhaust pipe bend. Use elbows instead.

Donaldson & Industry Acronyms

ATD	After Treatment Device
Bp.....	Backpressure
CARB	California Air Resources Board
CCM.....	Catalytic Converter Muffler (or DOC)
CCV.....	Crankcase Ventilation or Closed Crankcase Vent
CDPF.....	Catalyzed Diesel Particulate Filter
CFM	Cubic Feet per Minute
CFS.....	Crankcase Filtration System
CO	Carbon Monoxide
dBA.....	Decibel, A scale (noise level)
DMF.....	Diesel Multi-stage Particulate Filter
DOC.....	Diesel Oxidation Catalyst
DPF	Diesel Particulate Filter
EAT.....	Exhaust After Treatment
EDM.....	Emissions Device Monitor
EGR.....	Exhaust Gas Recirculation
EIEO	End In / End Out (muffler style)
EISO.....	End In / Side Out (muffler style)
EPA	Environmental Protection Agency
EPA Tier 4/IV.....	Off-road emissions standards
EPA07	U.S. EPA 2007 on-road regulation
EPA10	U.S. EPA 2010 on-road regulation
ERC	Emissions Resource Center
Euro Stage XX	European Emissions Reduction Regulations
FTP.....	Federal Test Procedure
HC	Hydrocarbon (unburned fuel)
HP	Horse Power
HTEF	High Temperature Exhaust Filter
ICC	Independent Catalytic Converter
ID.....	Inside Diameter
IOM.....	Installation Operation Manual
ISO.....	International Organization for Standardization
ISO/TS	ISO Technical Specification
LNF.....	Low NO ₂ Filter (muffler)
LXF.....	Low NO _x Filter (muffler)
LSD	Low Sulfur Diesel (fuel)
LTF.....	Low Temperature Filter (muffler)
NO _x	Nitrogen Oxides
OCV.....	Open Crankcase Ventilation
OD	Outside Diameter
PM	Particulate Matter
SC.....	Silicone Carbide
SCR.....	Selective Catalyst Reduction
SEF.....	Semi-active Electric Filter (muffler)
SIEO.....	Side In / End Out (muffler style)
SISO.....	Side In / Side Out (muffler style)
SRF.....	Standard Recirculation Filter
SS.....	Stainless Steel
ULSD.....	Ultra-Low Sulfur Diesel (fuel)
VOC.....	Volatile Organic Compound
VOF	Volatile Organic Fraction

Engine Brake & Exhaust Silencer



Designed to specifically address engine brake noise

- Addresses engine brake noise, silencing engine brake “bark”
- Reduces exhaust noise 66% versus a standard muffler

Silences engine brake “bark”

- Reduces driver fatigue
- Improves trucking industry image

All stainless steel construction available*

- Won’t rust out like conventional mufflers

Direct replacement

- Easy installation, can be applied on existing trucks

No increase in back pressure

- Silences without engine power loss
- Maintains fuel economy

*Models available in both stainless steel and aluminized steel



Flat Band SealClamp™ Installation Instructions

SHOPTALK



Step 1

Position 1/3 to 1/2 way onto the larger diameter tube or to completely cover slots.

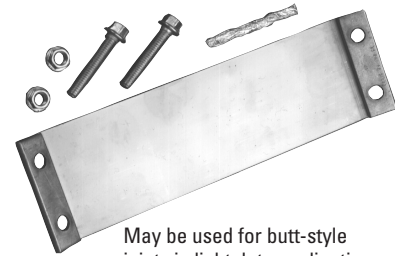

May be used for butt-style joints in light duty applications



Step 2

Assemble bolts between clamp bolts and tubes.



Step 3

For all models, tighten by alternating the wrench between fasteners several times to uniformly take up the slack, beginning with the large diameter side of the connection. Tighten the nuts for stainless clamps as illustrated. Tighten alternately until the gasket is fully compressed and the mating bars' surfaces are fully touching. The grade 8 bolts and nuts are rated to 100 ft. lbs. of torque. For best results use an impact wrench.

Important Application Notes

- Use either 9/16 inch (14mm) hex wrench
- Grease the clamps and the joint area before installing
- Do not use for exhaust system mounting support
- Do not use for exhaust manifold or turbocharger connections
- Do not reuse the clamps
- Do not use as a butt joint clamp—use for overlap connections only



Stepped Preformed SealClamp is Individually packaged with installation instructions

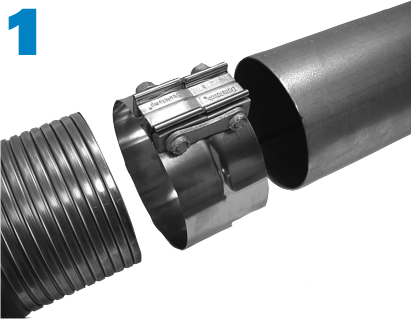

Unique design with fully assembled hardware!

1. Position the SealClamp over the smallest tube. Larger end of the clamp must be on the overlapping tube or flex.
2. Locate the step of the clamp to the overlapping tube at the joint.
3. Using the v-groove as a visual guide, alternately tighten bolts until the groove is approximately half closed (~50 ft. lbs). Do not exceed 70 ft. lbs. torque as clamp damage may occur.

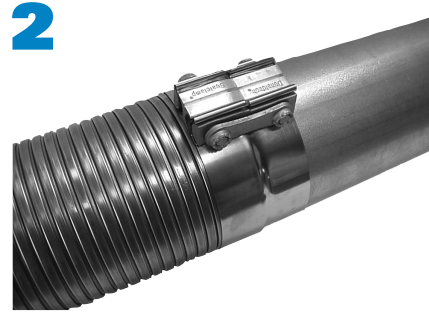

Diseño único para un ensamble completo!

1. Colocar el SealClamp sobre el tubo más pequeño. El diámetro mayor del SealClamp debe estar sobre el tubo rígido o flexible a sobrepasar.
2. Ubicar el escalón de la abrazadera en la unión del tubo sobrepuesto.
3. Usando la ranura como guía visual, apriete alternadamente los pernos hasta que la ranura esté aproximadamente a medio cerrar. No exceda 47,5 N(m (35 lbs-pie) de par de apriete por que puede producir daños en la abrazadera.

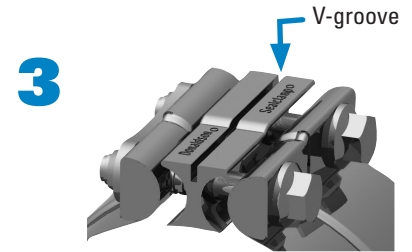

Before / Antes / Avant



After / Después / Après

Conception unique avec pièces entièrement assemblées!

1. Placer le collier sur le tuyau de diamètre inférieur. La portion la plus grande du collier doit se trouver sur le tuyau qui chevauche.
2. Positionner la partie étagée du collier sur la portion chevauchante du tuyau en l'alignant sur le joint.
3. En utilisant la rainure comme guide visuel, serrer alternativement les boulons, jusqu'à ce que la rainure soit à moitié fermée. Ne pas dépasser une force de torsion de 35 pied-livre, cela risquerait d'endommager le serre-joint.

Attenuation

In an exhaust system, attenuation refers to the reduction in sound level measured between an engine without a muffler and the same engine with a muffler.

Backpressure

Backpressure is the force necessary to flow exhaust gas through the system. Backpressure reduces horsepower and fuel economy - for turbocharged diesel engines - about 0.5% decrease in horsepower and fuel economy per inch Hg backpressure. Typically measured in inches of mercury (Hg) or inches of water (H₂O) - 1.0" Hg - 13.6" H₂O

CFM

Cubic feet per minute of airflow.

dBA

The sound level measured in decibels using a sound level meter weighted for the "A" scale frequency response. It has over 82% correlation with loudness as determined by the typical human ear (dB without the "A" scale weighting overall has only 70% correlation to loudness).

Decibel (dB)

A unit used to express the relative difference in acoustic power. Whenever dB is used a reference level is implied. The reference value of 0.0002 dynes/cm² = 0dB.

DOC Muffler

Diesel Oxidation Catalyst (DOC) Muffler. This muffler design contains a catalyst inside that reduces emissions while reducing exhaust noise. Also referred to as a catalytic converter muffler (CCM).

DPF Muffler

Diesel Particulate Filter (DPF) Muffler. This muffler design contains a particulate filter that requires Ultra Low Sulfur Diesel fuel. The filter eliminates a greater amount of particulate matter compared to a DOC Muffler, but has a higher activation temperature (260°C). Like a DOC, it also reduces emissions while reducing exhaust noise.

Dynamometer Test

A test that allows an engine to be run to full horsepower and rated RPM while remaining stationary.

Exhaust Noise Level

Sound level of the exhaust system, typically measured in dBA.

N/A

Naturally aspirated

Resonator

A device inserted in the exhaust system ahead of the muffler that provides additional exhaust noise silencing without adding significant backpressure.

Sound Level Meter

A sound level measuring device that includes a microphone, an amplifier, an output meter and sound frequency networks for measuring sound levels in decibels,

Total Vehicle Noise

The sum of exhaust noise level measurement plus fan, intake, mechanical and tire noise. Noise levels add logarithmically (equal noise levels combined add 3 dB; example 75 dB + 75 dB = 78 dB).

If the airflow information is not available from the engine manufacturer, the calculations on page 7 may be helpful as you validate and specify mufflers and components.

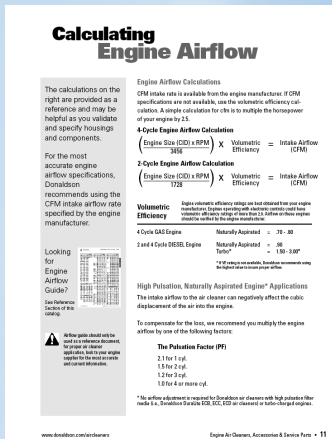

For assistance in calculating engine flow, please contact Donaldson customer service.



The data on engines in this section is to be used as a reference only. If specifying a new muffler for an engine, Donaldson recommends that you acquire this information directly from the engine manufacturer. If you can not acquire the information from the engine manufacturer, we recommend that you calculate the flow based on our instructions on page 7.



DO NOT use this information for the selection of retrofit emissions devices.

For the most accurate engine flow specifications, Donaldson recommends using the flow rates specified by the engine manufacturer.

Engine Manufacturers

- | | |
|--------------------|----------------------|
| Allis Chalmers | Lombardini |
| Case | Mack |
| Caterpillar | Mercedes-Benz |
| Continental Motors | Mitsubishi |
| Cummins | MTU of North America |
| Detroit Diesel | Navistar |
| Deutz | Nissan |
| Ford | Perkins |
| Hatz Diesel | Renault |
| Hino | Same |
| Isuzu | Teledyne |
| Iveco | Volkswagon |
| John Deere | Volvo |
| Kohler | Waukesha |
| Kubota | White Eng |
| Lister | Yanmar |

EXHAUST FLOW REFERENCE

Engine Model	RPM	HP	Intake CFM	Temp. (°F)	Flow (CFM)
ALLIS CHALMERS					
10000.....	2200	145	265		
11000.....	2200	220	560		
16000.....	2100	250	420		
17000 MKII ..	2100	300	780		
2000.....	2100	59	97		
21000 MKII ..	2100	375	875		
213.....	3600	32	75		
2200.....	2100	55	97		
25000 MKII ..	2100	450	1050		
2800.....	2600	85	200		
2900.....	2600	135	340		
320.....	3600	53	114		
3400.....	2400	125	240		
3500.....	2400	175	380		
3700.....	2400	200	400		
426.....	3600	72	150		
433I.....	2400	100	247		
433T.....	2400	90	242		
6000.....	2200	104	218		
61000.....	2100	800	2300		
6138I.....	2100	450	1060		
6138LT.....	2100	325	790		
6138T.....	2100	375	875		
649I.....	2600	155	430		
649T.....	2600	135	390		
65000.....	2100	900	2400		
670I.....	2400	200	490		
670T.....	2400	175	460		
685I.....	2200	266	680		
685T.....	2200	220	555		
7000.....	2200	160	300		
D175.....	2200	52	85		
D262.....	2200	78	128		
D344.....	1800	88	143		
CASE					
301BD.....	2200	94	153	1000	414
336BD.....	2200	104	171	1000	462
336BDT.....	2200	126	267	850	648
451BD.....	2200	142	360	1000	973
451BDT.....	2200	181	380	900	957
504BD.....	2200	155	275	950	718
504BDT.....	2200	221	440	900	1108
504BDTI.....	2200	256	600	950	1567
A267D.....	2000	73	123	1000	333
A284.....	2000		136	1000	368
A377.....	1800		139	1000	376
A451D.....	2000	145	200	1000	541
G188.....	2000	49	82	1000	222
G188D.....	2250	62	138	1000	373
CATERPILLAR					
1160.....	2800	225	410	1050	1146
1673T.....	2200	250	600	950	1567
1674TA.....	2200	270	690	900	1738
1693TA.....	2100		1080	900	2720
3116.....	2600	200	618	856	1511
	2600	250	713	867	1755
	2450	275	685	929	1773
	2600	300	745	984	2006

Engine Model	RPM	HP	Intake CFM	Temp. (°F)	Flow (CFM)
3126B.....	2200	175	1239	660	2640
	2300	190	1355	716	3017
	2200	210	1327	741	3031
	2200	230	593	808	1471
	2200	250	635	821	1595
	2200	275	649	867	1683
	2200	300	660	916	1778
	2400	330	709	931	1937
3140.....	2800		410	1000	1109
3145.....	2800		410	1050	1146
3150.....	2800		410	1000	1109
3160.....	2800		410	1080	1169
3176.....	1800	275	692	676	1458
	1800	300	738	693	1579
	1800	350	802	760	1819
	1800	365	805	808	1900
3204NA.....	2400	66	193	980	515
3208ATAC.....	up to 300			950	
3208N.....	2200	165	325	1076	930
3208NA.....	2800	210	410	1000	1109
3208T.....	2800	250	646	900	1627
	2200	215	591	855	1443
3208T-DIATAAC	2600	275	752	854	1837
	2800	300	871	874	2162
3208T-DIT.....	2600	250	649	976	1740
3304B.....	up to 165			950	
3304NA.....	2200	102	206	1050	576
3304T.....	2200	165	264	900	665
3306.....	1900	300	745	1019	2059
3306B.....	1800	285	745	825	1781
	1800	300	777	843	1887
3306NA.....	2200	150	325	950	849
3306T.....	2200	250	600	900	1511
	up to 300			850	
3306TA.....	2200	270	624	950	1629
3406.....	1900	425	1109	880	2758
3406B.....	1800	300	930	655	1917
	1800	330	986	705	2125
	1800	350	1016	739	2255
	1800	400	1052	753	2364
	1800	425	1077	806	2532
	1900	460	1108	847	2694
3406E.....	1800	355	967	762	2301
	1800	375	1023	899	2717
	1800	435	1066	901	2872
	1800	455	1083	919	2925
	1800	475	1105	937	3017
	1800	500	1119	954	3098
	1800	575	1164	959	3236
	1800	600	1164	959	3236
3406T.....	2100	339	910	900	2292
3406TA.....	2100	375	1000	900	2519
3408T.....	2100	425	980	900	2468
3408TA.....	2100	475	1220	900	3073
3412T.....	2100	650	1719	870	4234
3412TA.....	2100	750	2426	900	6420
3508.....	1800	1000	2490	900	6271
3512.....	1800	1500	3695	900	9306
3516.....	1800	2000	4830	900	12164
3606.....	1000	2475	5850	850	14192
3608.....	1000	3330	7235	800	16882
3612.....	1000	4950	11700	800	27300
3616.....	1000	6655	14470	800	33763
5.4-6.....	2000	437	1041	950	2718
5.4-8.....	1900	614	1477	950	3857

Engine Model	RPM	HP	Intake CFM	Temp. (°F)	Flow (CFM)
5.4V12.....	1900	896	1936	900	4876
5.75-6.....	1330	317	780	950	2037
6.25-6.....	1375	440	1111	950	2901
C-10.....	1800	305	755	821	1888
	1800	335	766	918	2078
	1800	350	752	892	1997
	1800	370	766	918	2078
C-12.....	1800	335	805	876	2110
	1800	355	815	859	2121
	1800	380	826	898	2202
	1800	395	833	924	2265
	1800	410	836	937	2287
	1800	425	815	922	2220
	1800	430	826	948	2276
	1800	455	819	953	2269
C-15.....	1800	355	963	762	2294
	1800	375	1023	899	2714
	1800	435	1066	902	2830
	1800	455	1083	919	2925
	1800	475	1105	937	3017
	1800	500	1119	954	3098
C-16.....	1800	575	1154	941	3165
	1800	600	1164	959	3236
D330NA.....	2200	100	227	1050	635
D330T.....	2200	165	418	950	1091
D333NA.....	2200	150	349	1000	944
D333T.....	2200	250	613	900	1544
D334TA.....	2200	280	689	950	1799
D336TA.....	2200	350	895	950	2337
D342NA.....	1300	200	418	1050	1169
D342T.....	1300	300	887	950	2316
D343T.....	2000	315	786	950	2052
D343TA.....	2000	425	996	900	2508
D346TA.....	2000	565	1350	900	3400
D348TA.....	2000	850	2048	900	5158
D349TA.....	2000	1130	2827	900	7120
D353TA.....	1300	490	1091	900	2748
D379TA.....	1300	650	1501	900	3780
D398TA.....	1300	975	2323	900	5851
D399T.....	1300	1300	3009	900	7578
CONTINENTAL MOTORS					
E201.....	2400		104	1100	300
F124.....	2400		65	1100	188
F135.....	2000	40	58	1100	168
F140.....	2400		84	1100	243
F162.....	2400	60	84	1100	243
F186.....	2400		101	1100	292
F209.....	2400		109	1100	315
F226.....	2400		115	1100	332
F227.....	2400	78	116	1100	335
F244.....	2400		126	1100	364
F245.....	2400	88	127	1100	367
G134.....	2000		58	1100	168
G157.....	2000		68	1100	196
H227.....	2000		96	1100	277
H243.....	2000		104	1100	300
H260.....	2000		112	1100	324
J382.....	2000		160	1100	462
L478.....	2400	162	265	1100	766
M271.....	2400		141	1100	407
M290.....	2400		151	1100	436
M330.....	2400		172	1100	497
M363.....	2400	122	201	1100	581
N56.....	2200		27	1100	78
N62.....	2400		31	1100	90

Engine Model	RPM	HP	Intake CFM	Temp. (°F)	Flow (CFM)
CONTINENTAL MOTORS CONTINUED					
R513	2400		267	1100	771
R572	2400		298	1100	861
R602	2400	191	313	1100	904
S749	2200		358	1100	1034
S802	2200		392	1100	1132
S820	2400	250	455	1100	1314
T&B371	2400		193	1100	558
T&B427	2400	133	241	1100	696
U501	2400		260	1100	751
V603	2800		313	1100	904
Y112	2400	37	58	1100	168
Y69	2400		37	1100	107
Y91	2400	27	91	1100	263

Engine Model	RPM	HP	Intake CFM	Temp. (°F)	Flow (CFM)
CUMMINS					
3B2.9	2500	56	115	1000	311
4B3.9	2500	76	150	1050	419
4BT	2500	105	289	890	750
4BT	2500	120	336	970	922
4BT3.9	2500	100	253	1000	684
4BT3.9-G1	1800	86	147	850	357
4BT3.9-G2	1800	102	157	850	381
4BTA3.9	2500	120	298	900	751
6B5.9	2500	116	226	1000	611
6BT	2500	190	590	780	1290
	2500	230	535	1031	1531
	2300	230	520	910	1380
6BT5.9	2500	152	381	900	960
6BT5.9-G1	1800	135	224	900	564
6BT5.9-G2	1800	166	285	900	718
6BTA5.9	2500	180	449	900	1131
6C8.3	2500		316	1000	854
6CT	2300	250	570	930	1740
	2200	300	742	1000	2140
	2000	275	590	985	1665
6CT8.3	2500		555	900	1398
6CTA8.3	2500	250	632	900	1592
C-160	2500	153	300	900	756
C-180	2500	173	350	900	881
C-190	2500	190	495	900	1247
FLEET 270	1600	270	710	900	1788
FLEET 300	1600	300	765	900	1927
	1600	300	710	900	1788
Formula 240	1800	240	630	900	1587
	1800	240	618	900	1556
Formula 270	1800	270	720	900	1813
Formula 300	1800	300	761	900	1917
	1800	300	745	900	1876
	1800	300	744	900	1874
Formula 315	1800	315	735	900	1851
Formula 350	1800	350	821	900	2068
	1800	350	800	900	2015
	1800	350	857	900	2158
Formula 400	1900	400	1060	900	2670
	1900	400	930	950	2428
	1900	400	986	900	2483
Formula 450	1900	450	1110	950	2898
Formula L10-240					
	1900	240	522	900	1315
	1900	240	580	900	1461
	1900	240	585	900	1473

Engine Model	RPM	HP	Intake CFM	Temp. (°F)	Flow (CFM)
-- Exhaust --					
Formula L10-270					
	1900	270	556	900	1400
	1900	270	618	900	1556
	1900	270	606	900	1526
Formula L10-300					
	1900	300	609	900	1534
GNH-220-IP	1800	177	250	900	630
GNH-250-IP	1800	204	265	900	667
GV-12-525-IP	1800	408	580	900	1461
ISB	2500	185	578	698	1257
	2600	190	526	801	1250
	2500	205	508	831	1246
	2600	210	526	857	1313
	2500	225	510	892	1311
	2500	240	610	812	1456
	2500	245	610	812	1456
	2600	260	622	886	1592
	2500	275	620	956	1673
ISC	2400	225	708	706	1417
	2400	240	721	746	1485
	2400	260	743	765	1578
	2200	285	682	833	1531
	2200	300	688	860	1578
	2200	315	682	919	1686
	2200	330	693	927	1758
	2200	350	706	966	1841
ISL	2100	310	689	891	1682
	2100	330	708	933	1740
ISM	2100	280	777	670	1523
	1800	310	734	721	1528
	1800	330	773	742	1610
	2100	350	888	720	1778
	2100	370	918	737	1853
	2100	400	918	737	1853
	2100	425	855	969	2171
	2100	450	974	789	2030
	2100	500	940	965	2341
ISX	1800	400	1063	655	2036
	1800	450	1129	696	2218
	2000	475	1126	842	2504
	2000	500	1125	905	2633
	2000	600	1227	975	3202
KT-1150-C	2100	450	1130	900	2846
KT-2300-C	2100	900	2400	880	5956
KT-450	2100	450	1130	850	2741
KTA-1150-C	2100	600	1400	900	3526
	2100	525	1410	880	3499
KTA-2300-C	2100	1200	2900	900	7304
	2100	1050	2700	900	6800
KTA-3067-C	2100	1600	3760	900	9470
	2100	1350	3455	900	8701
KTA-525	2100	525	1425	850	3457
KTA-525-FORM					
	1900	525	1200	850	2911
KTA-600	2100	600	1400	850	3396
KTTA-19-C		650		900	
KTTA-38-C		1350		900	
KTTA-50-C		2000		900	
L10	1700	260	615	745	1300
	1700	280	640	760	1407
	1600	310	638	825	1470
	2100	270	670	900	1687
	2100	300	659	900	1660

Engine Model	RPM	HP	Intake CFM	Temp. (°F)	Flow (CFM)
-- Exhaust --					
M11	1600	280	615	817	1476
	1600	310	670	813	1390
	1600	350	760	822	1554
	1600	370	770	828	1641
	1600	400	840	832	1801
N-855-C	2100	220	460	850	1116
	2100	235	460	850	1116
N-927	1950	240	465	880	1154
	2100	260	495	880	1228
	2100	240	495	880	1228
N14	1800	330	1014	657	1997
	1800	400	1126	723	2354
	2100	350	1212	606	2254
	2100	370	1283	651	2474
	2100	460	1329	737	2737
	2100	500	1380	802	2984
	2100	525	1380	802	2984
	2100	410	1164	670	2614
	2100	435	1302	714	2639
	2100	550	1380	802	2984
	2100	525	1380	802	2984
NH-220	2100	212	470	900	1184
NH-230	2100	220	460	900	1159
NH-230S	1800	186	460	900	1159
NH-250-M	2100	240	460	950	1201
	1800	190	395	1050	1105
	1800	200	395	900	995
	2100	210	460	900	1159
NHC-250	2100	240	460	900	1159
	2300	240	710	900	1788
NHC-250-D	2100	240	460	900	1159
NHD-230	2100	220	495	900	1247
NHF-240	2300	230	505	900	1272
NHF-265	2300	255	505	900	1272
NHH-250	2100	240	460	900	1159
NHHTC-335	2100	335	850	850	2062
NHTF-295	2300	295	710	900	1788
NT-335-M	1800	235	625	950	1632
	1800	265	650	900	1637
	2100	285	775	950	2024
	2100	335	800	950	2089
NT-380-M	2300	380	950	950	2481
	2000	253	700	1000	1893
	2000	300	750	900	1889
	2300	320	900	980	2400
NT-855-C	2100	310	895	880	2221
	2100	280	860	850	2086
	2100	250	825	850	2001
	2100	335	920	900	2317
	2100	335	900	900	2267
	2100	280	820	900	2065
	2100	250	680	880	1687
	2100	310	835	900	2103
NTA-370	1950	335	810	850	1965
	2100	370	950	850	2305
NTA-400	2100	400	1000	850	2426
NTA-420	2300	420	1080	900	2720
NTA-855-C	2100	400	1000	880	2481
	2100	360	960	880	2382
	2100	360	980	900	2468
	2100	400	1050	900	2644
NTC-270-CT	2100	240	740	850	1795
	2100	225	760	900	1914
	2100	270	825	900	2078

EXHAUST FLOW REFERENCE

Engine Exhaust Flow & Air Consumption Guide



EXHAUST FLOW REFERENCE

Engine Model	RPM	HP	Intake CFM	-- Exhaust --	
				Temp. (°F)	Flow (CFM)
CUMMINS CONTINUED					
NTC-290	2100	270	665	950	1736
	2100	290	685	900	1725
	1950	255	580	920	1482
NTC-300	2100	300	936	900	2357
NTC-335	2100	280	780	880	1936
	2100	300	805	880	1998
	2100	335	850	900	2141
	2100	320	830	900	2090
NTC-350	2100	350	885	900	2229
	2100	335	865	880	2146
	2100	320	845	880	2097
	1950	310	760	850	1844
	2100	350	986	900	2483
	2100	350	930	900	2342
NTC-400	2100	400	1165	950	3042
	2100	400	1030	900	2594
NTCC-300	2100	300	868	900	2186
NTCC-350	2100	350	1000	900	2519
NTCC-400	2100	400	1090	900	2745
NTF-295	2300	295	710	850	1722
NTF-365	2300	365	960	920	2453
P.TORQ 240	2100	240	618	900	1556
P.TORQ 270	2100	240	735	900	1851
	2100	270	840	900	2116
P.TORQ 315	2100	315	890	950	2324
P.TORQ L10-240					
	2100	240	645	900	1624
	2100	240	577	900	1453
	2100	240	647	900	1629
P.TORQ L10-270					
	2100	270	630	900	1587
Signature	2000	500	1072	959	2638
	2000	565	1117	986	2777
	2000	600	1164	1013	2936
SUPER 250	2100	240	495	900	1247
V-12-500-M	2100	480	840	900	2116
	1800	370	720	950	1880
	1800	400	720	900	1813
	2100	425	840	950	2193
V-378-C	3000	145	277	900	698
V-504-C	3000	195	357	900	899
V-504-M	3300	202	425	950	1110
	2500	158	322	900	811
	3300	197	386	900	972
V-555	3300	216	470	880	1166
V-555-C	3000	215	430	850	1043
V-555-E	3300	202	470	900	1184
V-903	2600	307	610	900	1536
	2600	255	610	900	1536
	2600	269	610	900	1536
	2600	288	610	880	1514
V-903-C	2600	295	610	880	1514
	2600	265	610	850	1480
V-903-M	2600	307	610	950	1593
	2300	250	545	900	1373
	2500	302	585	900	1473
V-9035	2200	250	520	880	1290
V5-120-635-M					
	1800	435	1060	900	2670
V5-120-635-M					
	2100	540	1380	900	3476
V6-155	3300	149	318	950	830
V8-185-E	3300	178	425	950	1110
V8-210	3300	202	425	950	1110

Engine Model	RPM	HP	Intake CFM	-- Exhaust --	
				Temp. (°F)	Flow (CFM)
V8-300	3000	288	580	970	1536
V8-300-M	3000	288	585	950	1528
	2600	220	505	900	1272
	2800	260	545	950	1423
VT-12-635-M					
	2100	635	1460	950	3812
	1800	490	1100	900	2770
VT-12-700-M					
	2100	700	1600	980	4267
	1800	480	1130	900	2846
	1800	545	1190	900	2997
	2100	595	1500	950	3917
VT-12-800-M					
	2100	800	1820	950	4752
	1800	550	1325	900	3337
	1800	620	1400	900	3526
	2100	680	1700	950	4439
VT-1710-C	2100	635	1700	900	4281
VT-555	3000	220	625	900	1574
VT-555-C	3000	230	585	850	1419
VT-903	2600	307	850	900	2141
		350	1050	900	2644
	2600	320	930	900	2342
VT-903-C	2600	350	920	900	2317
	2600	320	905	900	2279
VT8-370-M	3000	370	930	950	2428
	2600	270	760	900	1914
	2800	320	865	950	2259
VTA-1710-C	2100	700	1880	950	4909
	2100	800	2100	980	5600
VTR-28-C		900		900	
DETROIT DIESEL					
12V-149	1900	800	2800	850	6793
12V-149T	1900	1000	3600	850	8733
12V-149TI	1900	1200	4300	850	10431
12V-71	1800	350	1128	850	2736
	2300	471	1430	850	3469
	2100	456	1309	850	3176
12V-71T	2100	525	1800	850	4367
	1800		1650	850	4003
16V-149	1900	1060	3600	850	8733
16V-149T	1900	1325	4800	850	11644
16V-149TI	1900	1600	5500	850	13343
16V-71	2100	608	1748	850	4241
	1800	466	1506	850	3653
16V-71T	1800		2240	850	5434
	2100	700	2300	850	5580
16V-92	1800	600	1960	850	4755
	2100	720	2300	850	5580
16V-92T	2100	860	3200	850	7763
	1800		2600	850	6307
2-53	1800		130	850	315
	1200		91	850	221
	200		142	850	344
2-71	200	65	223	850	541
	1800	48	200	850	485
	1200		131	850	318
3-53/2-VAL	2200	75	242	850	587
	1800	59	202	850	490
	2200		253	850	614
	2800	98	319	850	774
3-53T	2500	125	500	850	1213
	2500	125	500	850	1213
3-71	1800	82	319	850	774
	2100	109	375	850	910
	1200		207	850	502

Engine Model	RPM	HP	Intake CFM	-- Exhaust --	
				Temp. (°F)	Flow (CFM)
4-35T	2500	170	596	850	1446
4-53/2-VAL	2200	103	340	850	825
	1000		282	850	684
	2200		356	850	864
	2800	136	450	850	1092
4-53T	2500	170	596	850	1446
	1200		275	850	667
	2300	159	550	850	1334
	1800	117	425	850	1031
	2100	152	500	850	1213
6-71	2300	236	825	850	2001
	1800	175	637	850	1545
	2100	228	750	850	1819
	1200		413	850	1002
6-71T	2100	275	1045	850	2535
6-71TT	1950	230	930	850	2256
6-V-71	2300	236	715	850	1735
	1800	175	564	850	1368
	2100	228	655	850	1589
6V-53	2200		534	850	1295
	2800	210	675	850	1638
	2600		627	850	1521
6V-53T	2500	230	855	850	2074
6V-92	1800	225	730	850	1771
	2100	270	860	850	2086
6V-92T	1800		1000	850	2426
	2100	322	1200	850	2911
6V-92TA	2100	335	1225	850	2972
6V-92TT	1950		1030	850	2499
6V-92TTA	1950	270	1050	850	2547
8.2LN	3000	165	376	850	912
8.2LT	3000	205	553	850	1342
8V-53	2200		693	850	1681
	2500		786	850	1907
8V-71	1800	233	753	850	1827
	2300	314	954	850	2314
	2100	304	874	850	2120
8V-71T	2100	350	1200	850	2911
	1800		1100	850	2669
8V-71TA	2100	370	1240	850	3008
8V-71TT	1950		1240	850	3008
8V-71TTA	1950	305	1055	850	2559
8V-92	1800	300	980	850	2377
	2100	360	1150	850	2790
8V-92T	2100	430	1600	850	3881
	1800		1300	850	3154
8V-92TA	2100	435	1434	850	3479
8V-92TT	1950		1300	850	3154
8V-92TTA	1950	365	1250	850	3032
Series 40E (7.6 LTA)					
	2300	175	675	670	1450
	2600	190	705	710	1575
	2600	210	740	765	1730
	2600	230	700	885	1810
	2400	195	715	720	1610
	2400	250	700	885	1810
Series 40E (8.7 LTA)					
	2200	250	685	850	1725
	2200	275	705	955	1890
	2200	300	710	965	1930
	2200	320	715	985	1995

Engine Model	RPM	HP	-- Exhaust --	
			Intake Temp. (°F)	Flow (CFM)
DETROIT DIESEL CONTINUED				
Series 50 (8.5 Ltr)				
2100	250	760	625	1575
2100	275	790	680	1720
2100	300	820	715	1845
2100	320	815	730	1861
2100	350	815	850	2055
Series 60 (12.7 Ltr)				
2100	330	1050	610	2157
2100	350	1090	645	2310
2100	370	1010	725	2300
2100	400	1050	780	2500
2100	430	1080	820	2652
2100	470	1170	825	2877
2100	500	1170	825	2877
Series 60 (14 Ltr)				
2100	550	1231	986	3402
2100	575	1271	867	3221

DEUTZ					
BF12L 714	2300	390	695	850	1686
BF6L 913	2800	175	396	850	961
F10L 413	2650	310	595	850	1443
F10L 714	2300	275	577	850	1400
F12L 413	2650	370	714	850	1732
F12L 714	2300	330	695	850	1686
F1L 208	3600	9	70	850	170
F1L 210	3000	16	96	850	233
F1L 411D	3000	16	98	850	238
F2L 411D	3000	32	133	850	323
F2L 411W	3000	30	133	850	323
F2L 912	2500	36	150	850	364
F2L 912W	2500	34	150	850	364
F3L 912	2800	60	176	850	427
F3L 912W	2500	50	158	850	383
F4L 912	2800	80	202	850	490
F4L 912W	2500	67	180	850	437
F5L 912	2800	100	210	850	509
F5L 912W	2500	84	187	850	454
F6L 413	2650	185	357	850	866
F6L 714	2300	165	347	850	842
F6L 912	2800	120	252	850	611
F6L 912W	2500	101	224	850	543
F8L 413	2650	250	476	850	1155
F8L 714	2300	220	463	850	1123

FORD					
00	2400	59	101	900	254
172DF	2400	59	101	900	254
175DF	2500	52	108	900	272
183D	2200	52	99	900	249
192DF	2400	65	113	900	285
201DF	2250	66	111	900	280
220	2400	69	130	900	327
233D	2100	68	120	900	302
242D	2230	76	133	900	335
242DF	2500	79	149	900	375
254DF	2500	80	157	900	395
256DF	2500	89	157	900	395
3320DF	2500	111	203	900	511
362DF	2500	121	223	900	562
363DFT	2400	150	214	900	539
380DF	2500	120	233	900	587
401DF	2500	132	246	900	620
401DFT	2500	167	246	900	620

Engine Model	RPM	HP	-- Exhaust --		
			Intake Temp. (°F)	Flow (CFM)	
67GF	3600	32	60	900	151
98GF	3600	45	87	900	219
X	2250	60	122	900	307
Y	2250	96	183	900	461

HATZ DIESEL					
2L30	3000	30	68	1100	196
2L40	3000	37	82	1100	237
2M40	3000	40	85	1100	246
3L30	3000	45	101	1100	292
3L40	3000	55	123	1100	355
3M40	3000	60	130	1100	376
4L30	3000	60	135	1100	390
4L40	3000	74	164	1100	474
4M40	3000	80	170	1100	491
E573	3000	3	14	1100	40
E673	3000	5	16	1100	46
E75	3000	7	18	1100	52
E780	3000	10	25	1100	72
E786	3000	14	30	1100	87
E79	3000	8	20	1100	58
E88	2600	10	28	1100	81
E89	2600	12	30	1100	87
E950	3000	17	36	1100	104
Z788	3000	23	55	1100	159

HINO					
Z790	3000	30	61	1100	176
DK10	2000	132	325	900	819
DK10T	1800	160	425	900	1070
DM100	2400	62	165	900	416
EB300	2000	132	315	900	793
EC100	2600	76	208	900	524
EF550	2200	230	572	900	1441
EF750	2200	245	589	900	1483
EF750T	2200	272	850	900	2141
EH100	2600	93	244	900	615
EH500	2800	114	277	900	698
EH700	2800	118	290	900	730
EK100	2200	196	467	900	1176
EL100	2600	132	327	900	824
EL100T	2400	145	440	900	1108
EM100	2400	148	362	900	912
ER100	2200	160	407	900	1025
EV700	2200	298	700	900	1763

ISUZU					
QD100	3200	87	185	900	466
QD130	2800	115	230	900	579
QD145	3200	129	280	900	705
QD145T	2500	139	305	900	768
QD200	2200	194	410	900	1033
QD200T	2000	218	515	900	1297
QD27	2800	26	50	900	126
QD40	2800	40	80	900	201
QD60	3800	55	140	900	353
QD85	3000	68	162	900	408
QD90	2800	75	150	900	378
QT15	3600	14	55	900	139
QT23	3600	22	75	900	189
QT35	3000	32	96	900	242

Engine Model	RPM	HP	-- Exhaust --		
			Intake Temp. (°F)	Flow (CFM)	
IVECO					
803 i 3L-NA	2500	51	120	1100	347
804 i 4L-NA	2500	68	155	1100	448
805 i 5L-NA	2500	84	74	1100	214
806 i 6L-NA	2500	102	235	1100	679
806 i tc 6L-TC	2500	131	340	900	856
8210 i 6L-NA	2000	205	440	1100	1271
8280 i V8-NA	2200	287	600	1100	1733
8281 SRi V8-TCA	2200	424	900	900	2267
8281 Si V8-TC	2000	331	790	900	1990
8361 Si 7L-TC	2400	157	450	900	1133
8361 i 6L-NA	2500	139	322	1100	930

JOHN DEERE					
3164D	2500	52	100	900	252
3179D	2500	58	100	900	252
3179T	2500	79	178	900	448
4219D	2500	70	135	900	340
4239A	2500	117	277	900	698
4239D	2500	80	148	900	373
4239T	2500	109	258	900	650
4276D	2500	82	160	900	403
4276T	2200	98	266	900	670
6076A	2200	240	568	900	1431
6076H	2200	250	647	900	1629
6076T	2200	190	505	900	1272
6329D	2500	104	200	900	504
6359A	2500	176	470	900	1184
6359D	2500	121	228	900	574
6359T	2500	163	370	900	932
6414D	2200	118	228	900	574
6414T	2200	146	360	900	907
6466A	2100	233	579	900	1458
6466D	2200	138	258	900	650
6466T	2200	185	484	900	1219
6619A	2100	301	680	900	1713
8955A	2100	456	1130	900	2846
8955T	2100	356	978	900	2463

KOHLER					
K161	3600	7	14	1150	42
K181	3600	8	16	1150	48
K241	3600	10	20	1150	60
K301	3600	12	24	1150	72
K321	3600	14	26	1150	78
K341	3600	16	30	1150	89
K582	3600	23	48	1150	143
K91	3600	4	7	1150	21
KT17	3600	17	35	1150	104
KT19	3600	19	39	1150	116

KUBOTA				
---------------	--	--	--	--

Engine Exhaust Flow & Air Consumption Guide



EXHAUST FLOW REFERENCE

Engine Model	RPM	HP	Intake CFM	-- Exhaust --	
				Temp. (°F)	Flow (CFM)
D1402-B	2800	31	62	900	156
D3200-B	2400	66	123	900	310
D600-B	3600	16	35	900	88
D850-BW	3000	20	41	900	103
DH850-B	3600	23	49	900	123
S2800-B	2600	58	116	900	292
V1100-B	3000	26	55	900	139
V1702-B	2800	40	77	900	194
V1902-B	2800	42	83	900	209
V4300-B	2400	88	164	900	413
VH1100-B	3600	31	66	900	166
Z400-B	3600	11	23	900	58
Z600-BW	3200	14	29	900	73
ZB400-B	3200	10	21	900	53
ZB600C-1-B	3200	14	29	900	73
ZH600-B	3600	16	33	900	83

LISTER

HL3	2500		125	900	315
HL4	2500		167	900	421
HL6	2500		250	900	630
HLT6	2100		300	900	756
HR2	2200		73	900	184
HR3	2200		110	900	277
HRW2	2200	31	74	900	186
HRW3	2200	47	110	900	277
HRW4	2200	62	146	900	368
HRW6	2200	93	220	900	554
HRWS6	2000	102	200	900	504
LT1	3600	8	24	900	60
LV1	3600	9	28	900	71
LV2	3600	18	55	900	139
ST1	3000	10	31	900	78
TL2	3000	27	74	900	186
TL3	3000	40	111	900	280
TS2	3000	22	61	900	154
TS3	3000	33	91	900	229

LOMBARDINI

10LD 400-2	3000	16	34	1000	92
10LD 400-2/B1					
3600	18	41	1000	111	
11LD 535-3	3000	33	74	1000	200
11LD 625-3	3000	38	84	1000	227
3LD 450	3000	10	20	1000	54
3LD 510	3000	11	22	1000	59
3LD 510/L	2200	8	17	1000	46
4LD 640	3000	14	28	1000	76
4LD 640/L	2200	10	22	1000	59
4LD 705	2600	15	27	1000	73
4LD 820	2600	18	32	1000	87
4LD 820/L	2200	14	27	1000	73
5LD 675-2	3000	29	58	1000	157
5LD 675-3	3000	44	87	1000	235
5LD 825-2	2600	34	63	1000	170
5LD 825-2/L	2200	27	53	1000	143
5LD 825-3	2600	52	94	1000	254
5LD 825-3/L	2200	40	80	1000	216
5LD 825-4	2600	67	125	1000	338
5LD 825-4/L	2200	54	106	1000	287
5LD 930-3	2600	54	105	1000	284
5LD 930-4	2600	72	140	1000	379
6LD 260	3600	5	15	1000	41
6LD 260/C	1800	5	14	1000	38
6LD 325	3600	7	17	1000	46

Engine Model	RPM	HP	Intake CFM	-- Exhaust --	
				Temp. (°F)	Flow (CFM)
6LD 325/C	1800	7	17	1000	46
6LD 360	3600	8	19	1000	51
6LD 360 V	3600	8	19	1000	51
6LD 400	3600	8	21	1000	57
7LD 665	3000	15	29	1000	78
7LD 665/F	3000	15	29	1000	78
7LD 740/L	3000	16	32	1000	87
8LD 600-2	3000	26	52	1000	141
8LD 665-2	3000	29	58	1000	157
8LD 665-2/L	2200	22	44	1000	119
8LD 740-2	2600	29	52	1000	141
9LD 561-2	3000	26	48	1000	130
9LD 561-2/L	2200	18	37	1000	100

MACK

E6	NA	350	NA	750	1950
E7	NA	300	NA	728	1561
	NA	350	NA	742	1679
	NA	400	NA	791	1934
	NA	427	NA	795	2136
	NA	460	NA	814	2315
	NA	310/330	NA	728	1550
	NA	330/355	NA	735	1653
	NA	355/380	NA	736	1767
E9	NA	500	NA	740	3050
EN291	2800		178	900	448
EN331	2800		206	900	519
EN402	2800		246	900	620
EN438	2600		247	900	622
EN540	2400		280	900	705
EN707C	2100		306	900	771
END465	2600		325	900	819
END475	2400		280	900	705
END5673C	2100	250	600	900	1511
END5864	2300	270	850	900	2141
END673E	2100	180	400	900	1007
END707	2100	200	410	900	1033
END864BC	2450		540	900	1360
ENDT475	2400		460	900	1159
ENDT673	2100	225	600	900	1511
ENDT675	2100	237	625	900	1574
ENDT676			800	900	2015
ENDT864A	2300		860	900	2166
ENDT865	2600	325	960	900	2418
ENDT866	2400	275	1050	900	2644
ENDTF673	2300		665	900	1675
ENDTF673C	2200		625	900	1574

MERCEDES-BENZ

OM314	2800	85	170	900	428
OM346	2800		427	900	1075
OM352	2800	130	260	900	655
OM352A	2800	168	336	900	846
OM355	2000	200	327	900	824
OM360	2500	190	308	900	776
OM401	2500	195	340	900	856
OM402	2500	260	340	900	856
OM403	2500	325	463	900	1166
OM404	2500	430	738	900	1859
OM407	2200	240	480	900	1209
OM407A	2200	280	560	900	1410
OM407h	2200	240	480	900	1209
OM407hA	2200	280	560	900	1410
OM421	2300	216	432	900	1088
OM422	2300	280	560	900	1410

Engine Model	RPM	HP	Intake CFM	-- Exhaust --	
				Temp. (°F)	Flow (CFM)
OM422A	2300	330	660	900	1662
OM422LA	2300	375	750	900	1889
OM423	2300	355	710	900	1788
OM423LA	2100	470	940	900	2367
OM424	2300	420	840	900	2116
OM424A	2300	530	1060	900	2670
OM424LA	2300	615	1230	900	3098
OM616	3600	67	134	900	337
OM617	3600	82	164	900	413
OM636	3500	40	95	900	239

MITSUBISHI

S12A-PT	1800	660	1620	900	4080
S12A-PTA	1800	850	2080	900	5239
S12A-PTK	1800	900	2190	900	5516
S12N-PT	1800	1000	2440	900	6145
S12N-PTA	1800	1130	2750	900	6926
S12N-PTK	1800	1230	3000	900	7556
S12U-PTA	1200	3100	7910	900	19921
S12U-PTK	1200	3300	8400	900	21156
S16N-PT	1800	1320	3210	900	8084
S16N-PTA	1800	1500	3670	900	9243
S16N-PTK	1800	1620	3960	900	9973
S6A-PT	1800	330	810	900	2040
S6A-PTA	1800	425	1020	900	2569
S6A-PTK	1800	450	1100	900	2770
S6B-PT	1800	260	640	900	1612
S6B-PTA	1800	320	780	900	1964
S6B-PTK	1800	360	880	900	2216
S6N-PT	1800	500	1240	900	3123
S6N-PTA	1800	565	1380	900	3476
S6N-PTK	1800	615	1480	900	3727
S6U-PTA	1200	1550	3960	900	9973
S6U-PTK	1200	1650	4200	900	10578
S8N-PT	1800	660	1620	900	4080
S8N-PTA	1800	750	1840	900	4634
S8N-PTK	1800	810	1980	900	4987

MTU OF NORTH AMERICA

12V-396-TB-83					
1845	1560	3919		3338	
12V-396-TB-93					
1845	1200	4534		3862	
12V-396-TC-82					
1745	1300	2902		2472	
8V-396-TB-83					
1845	1050	2436		2075	
8V-396-TB-93					
1845	1800	2944		2508	
8V-396-TC-82					
1745	870	1864		1588	

NAVISTAR

4-196	3800	86	162	1150	483
6.9 L	3000	170	330	1000	892
7.3 LT (T444)	2600	190	605	753	1359
7.3 L	3000	175	349	1000	944
9.0 L (DV550)	2800	185	410	1050	1146
C-200	2500	74	109	1150	325
C-221	2600	90	124	1150	370
C-263	2800	109	160	1150	477
C-301	2800	118	183	1150	546
C-345	3000	160	224	1150	668

NAVISTAR CONTINUED

C-392	3000	180	255	1150	760
-------	------	-----	-----	------	-----

Engine Model	RPM	HP	Intake CFM	-- Exhaust --	
				Temp. (°F)	Flow (CFM)
C-549.....	3200	232	381	1150	1136
C135B.....	2400	46	70	1150	209
C153.....	2400	53	80	1150	239
C175.....	2500	63	95	1150	283
D155.....	2500	48	95	900	239
D179.....	2400	59	99	900	249
D188.....	2400	62	104	900	262
D206.....	2500	56	119	900	300
D236.....	2400	65	131	900	330
D239.....	2500	80	138	900	348
D268.....	2500	85	165	900	416
D282.....	2400	95	156	900	393
D310.....	2300	101	165	900	416
D312.....	3000	117	216	900	544
D360.....	3000	136	250	900	630
D370.....	2200	105	188	900	473
D407.....	2600	127	245	900	617
D414.....	3000	157	287	900	723
D466.....	3000	165	323	900	813
D550B.....	3000	200	382	900	962
D554.....	2300	150	294	900	740
D691.....	1600	150	256	900	645
DT239.....	2500	110	225	900	567
DT358.....	2400	130	340	900	856
DT360.....	2700	190	588	850	1426
DT361.....	2600	146	341	900	859
DT402.....	2400	165	380	900	957
DT407.....	2500	160	368	900	927
DT414.....	3000	220	449	900	1131
DT420.....	2600	225	403	900	1015
DT466.....	2400	195	664	737	1520
DT466.....	2400	210	650	765	1530
DT466.....	2400	230	677	855	1710
DT466.....	2400	250	650	845	1640
DT466.....	2400	275	650	984	1820
DT573.....	2600	300	539	900	1357
DT573B.....	2600	260	525	900	1322
DT817.....	2100	385	975	900	2456
DT817B.....	2100	320	975	900	2456
DT817C.....	2200	420	975	900	2456
DVT800.....	2600	310	752	900	1894
MV-404.....	3600	188	315	1150	939
MV-446.....	3600	235	348	1150	1038
UC60.....	2500	17	33	1150	98
UR-450.....	2400	158	234	1150	698
UV-401.....	2800	165	243	1150	725
V-304.....	4400	180	298	1150	888
V-345.....	3800	172	284	1150	847
V-345.....	3800	168	284	1150	847
V-392.....	3600	236	306	1150	912
V-537.....	3200	208	372	1150	1109
VS-478.....	3400	224	352	1150	1049
VS-549.....	3200	243	381	1150	1136

NISSAN

A-12.....	4800	58	74	900	186
A-15.....	4800	78	95	900	239
ED-33.....	3200	83	168	900	423
FD-33T.....	3200	105	235	900	592
FD-6.....	2700	131	243	900	612
FD-6T.....	2700	148	340	900	856
H-20.....	3100	55	82	900	207
H-30.....	2600	66	102	900	257
J-15.....	2800	32	55	900	139
LD-20.....	2600	38	80	900	201
LD-28.....	2600	53	115	900	290

Engine Model	RPM	HP	Intake CFM	-- Exhaust --	
				Temp. (°F)	Flow (CFM)
ND-6.....	2400	130	260	900	655
P-40.....	2300	80	120	900	302
PD-6.....	2200	173	360	900	907
PD-6T.....	2200	227	505	900	1272
PE-6.....	2200	200	408	900	1028
PE-6T.....	2200	250	570	900	1436
RD10.....	2400	330	682	900	1718
RD10T.....	2400	415	1000	900	2519
RD10TA.....	2300	485	1200	900	3022
RD8.....	2400	265	545	900	1373
RD8T.....	2400	320	763	900	1922
SD-16.....	3200	36	85	900	214
SD-22.....	3200	51	110	900	277
SD-25.....	3200	60	126	900	317
SD-33.....	3200	79	165	900	416
SD-33T.....	3200	92	230	900	579

PERKINS

3.1522.....	2500	44	95	900	239
4-107.....	4000	57	99	900	249
4-108.....	4000	60	100	900	252
4-154.....	3600	80	128	900	322
4-203.....	2600	63	122	900	307
4-236.....	2800	80	153	900	385
4-248.....	2500	85	144	900	363
4-270.....	2000	62	125	900	315
4-300.....	2200	90	152	900	383
4-302.....	2300	76	161	900	405
4-318.....	2000	75	147	900	370
4-99.....	4000	55	92	900	232
4.108.....	4000	49	102	900	257
4.165.....	3600	70	135	900	340
4.2032.....	2250	58	117	900	295
4.236.....	2800	82	157	900	395
4.248.....	2500	84	152	900	383
4.318.....	2000	140	140	900	353
6-305.....	2600	89	184	900	463
6-354.....	2800	120	230	900	579
6-372.....	2500	121	215	900	541
6.247.....	3600	101	205	900	516
6.3544.....	2800	238	238	900	599
6.3724.....	2500	227	227	900	572
D3-152.....	2500	52	88	900	222
D3.152.....	2500	49	3	900	8
D4.203.....	2500	3	3	900	8
T6-354.....	2400	150	307	900	773
T6-354-3.....	2500	140	320	900	806
T6.3544.....	2600	370	370	900	932
TV8.640.....	2600	685	685	900	1725
V8-510.....	2800	185	331	900	834
V8-540.....	2500	166	312	900	786
V8-605.....	2500	200	350	900	881
V8.540.....	2600	370	370	900	932
V8.640.....	2600	411	411	900	1035

RENAULT

18TS/GTS.....	5750	92	230	1150	686
20 TL/GTL.....	5500	98	200	1150	596
20 TX.....	5500	112	230	1150	686
20 TX.....	5000	112	230	1150	686
4 GTL.....	4000	33	70	1150	209
4L/TL.....	4250	20	40	1150	119
9 TD/GTD.....	4800			900	
FUEGO TURBO D.....	4250	85	211	900	531

Engine Model	RPM	HP	Intake CFM	-- Exhaust --	
				Temp. (°F)	Flow (CFM)
TRAFIC.....	4750	46	90	1150	268
TRAFIC.....	5000	46	90	1150	268
TRAFIC PROP.....	4000	56	140	900	353

SAME

1052 LP.....	2500	39	83	900	71
1053 P.....	2500	64	124	900	106
1054 P.....	2500	85	165	900	141
1054 PT.....	2300	90	152	900	129
1055 P.....	2500	105	206	900	175
1056 P.....	2500	126	248	900	211
1056 PS.....	2300	148	228	900	194
1056 PT.....	2300	160	228	900	194
916.3A.....	3000	61	131	900	112
916.4A.....	3000	81	175	900	149

TELEDYNE

ACN.....	3600	6	13	900	11
AENL.....	3600	9	20	900	17
AGND.....	3200	12	26	900	22
BKN.....	3600	7	16	900	14
EY18-3W.....	3600	5	10	900	9
EY21W.....	3800	17	33	900	28
EY25W.....	3600	6	15	900	13
EY27W.....	3600	8	16	900	14
EY44W.....	3600	10	22	900	19
NH4D.....	2800	30	75	900	64
R08.....	5000	27	60	900	51
R11.....	4200	34	73	900	62
R14.....	4200	48	105	900	89
R17.....	5000	83	180	900	153
R22.....	5500	101	220	900	187
RD16.....	4800	54	135	900	115
RD21.....	4200	62	155	900	132
S-12D.....	3600	12	31	900	26
S-14D.....	3600	14	30	900	26
S-8D.....	3600	8	18	900	15
TJD.....	3600	18	48	900	41
TM13.....	3000	33	70	900	60
TM13.....	3000	22	45	900	38
TM20.....	3000	52	100	900	85
TM20.....	3000	44	90	900	77
TM27.....	3000	69	125	900	106
TM27.....	3000	59	120	900	102
TMD13.....	3000	29	72	900	61
TMD20.....	3000	44	110	900	94
TMD27.....	3000	121	300	900	256
TRA-12D.....	3600	12	25	900	21
V-465D.....	3000	66	133	900	113
V460D.....	3000	65	65	900	55
VE4.....	2400	48	48	900	41
VF4.....	2400	56	56	900	48
VG4D.....	2400	37	75	900	64
VH4.....	2800	61	61	900	52
VH4D.....	2800	30	65	900	55
VR4D.....	2200	37	122	900	104
W2-1230.....	3600	25	55	900	47
W2-1235.....	3600	30	68	900	58
W2-880.....	3600	20	44	900	37
W4-1770.....	3000	35	72	900	61
WD1-340.....	3000	7	18	900	15

TELEDYNE CONTINUED

WD1-350.....	3000	8	20	900	17
WD1-430.....	3000	10	24	900	20

Engine Exhaust Flow & Air Consumption Guide



EXHAUST FLOW REFERENCE

Engine Model	RPM	HP	Intake CFM	-- Exhaust --	
				Temp. (°F)	Flow (CFM)
WD1-450.....	3400	10	26		22
WD1-660.....	3000	15	38		32
WD1-670.....	3000	16	40		34
WD1-750.....	3000	17	43		37
WD2-1000.....	3000	21	52		44
WD2-860.....	3000	19	48		41
WI-145.....	4000	4	8		7
WI-145V.....	3600	4	8		7
WI-185.....	3600	5	10		9
WI-185V.....	3600	5	10		9
WI-340.....	3600	9	20		17
WI-390.....	3600	11	22		19
WI-588.....	3600	16	34		29

VOLKSWAGON

026.2.....	2200	70	140	1150	417
068.5.....	4000	48	90	900	227
068.A.....	4000	60	120	900	302
075.1.....	4000	75	145	900	365
126A.....	2000	45	90	1150	268

VOLVO

D45BPP.....	2300	75	195	900	491
TD100G.....	2000	223	460	900	1159
TD100GPP.....	2000	223	460	900	1159
TD120HP.....	2000	286	575	900	1448
TD121G.....	2000	284	575	900	1448
TD45B.....	2200	90	235	900	592
TD61A.....	2500	154	330	900	831
TD61AP.....	2500	165	350	900	881
TD61AW.....	2500	162	350	900	881
TD71A.....	2200	189	360	900	907
TD71AP.....	2200	192	360	900	907
TD71AW.....	2400	190	360	900	907
TID100KPP.....	2000	249	515	900	1297
TID121KP.....	2000	343	695	900	1750
TID121LP.....	1800	401	800	900	2015
TID71A.....	2200	216	380	900	957
TID71AP.....	2200	209	400	900	1007

WAUKESHA

190DLC.....	2800	84	128		109
197DLC.....	2800	91	208		177

Engine Model	RPM	HP	Intake CFM	-- Exhaust --	
				Temp. (°F)	Flow (CFM)
197DLCS.....	2800	131	320		273
D317D.....	2400	118	285		243
D317DS.....	2400	142	340		290
F1197D.....	1800	258	620		528
F1197DS.....	1800	400	960		818
F1197DSI.....	2400	462	1100		937
F1905DS.....	1200	397	860		733
F1905DSI.....	2200	514	1015		865
F2896D.....	1200	415	804		685
F2896DS.....	1200	695	1032		879
F2896DSI.....	1200	877	1305		1112
F475D.....	2400	182	440		375
F475DS.....	2400	216	520		443
F674D.....	2200	226	540		460
F674DS.....	2200	229	550		469
H1077D.....	2400	346	630		537
H1077DS.....	2400	522	1080		920
H1077DSI.....	2400	557	1190		1014
H866DS.....	2300	384	920		784
L1616D.....	2400	520	940		801
L1616DS.....	2400	785	1680		1431
L1616DSI.....	2400	836	1850		1576
L5100D.....	1200	830	1420		1210
L5100DS.....	1200	1232	2170		1849
L5100DSI.....	1200	1375	2560		2181
L5790D.....	1200	905	1710		1457
L5790DS.....	1200	1235	2600		2215
L5790DSI.....	1200	1754	3080		2624
LRDCS.....	1200	695	1032		879
NKDC.....	1200	297	566		482
NKDCS.....	1200	390	860		733
P2154D.....	2200	592	1420		1210
P2154DS.....	2200	1017	2450		2087
P2154DSI.....	2200	1077	2600		2215
VLRD.....	1200	905	1710		1457
VLRDS.....	1200	1235	2600		2215
VRD232.....	2200	68	160		136
VRD283.....	2200	76	180		153
VRD310.....	2400	106	255		217
WAKD.....	1800	258	530		451
WAKDS.....	1800	400	810		690

WHITE ENG

D-2000.....	2600	70	120		102
D-2300.....	2400		137		117

Engine Model	RPM	HP	Intake CFM	-- Exhaust --	
				Temp. (°F)	Flow (CFM)
D-2300T.....	2400		211		180
D-3000.....	2800	110	193		164
D-3000T.....	2600	130	280		239
D-3300T.....	1800		175		149
D-3400.....	2400		210		179
D-3400T.....	2400		333		284
D-4800.....	2400		260		221
D-4800T.....	2400		400		341
D-4800TA.....	2400		400		341
D-4800TAH.....	1800		431		367
G-1600.....	2400		102		87
G-2000.....	2800	84	120		102
G-2300.....	2400		130		111
G-3000.....	2800	130	181		154
G-3400.....	2400		210		179

YANMAR

12LAAL-DT.....	1800	1060	2772	900	6981
3T95LE.....	2800	51	114	900	287
4HAL.....	1800	110	260	900	655
4T95LE.....	2800	68	150	900	378
4T95LTE.....	2800	85	208	900	524
6HAL.....	1800	165	390	900	982
6HAL-DT.....	1800	330	837	900	2108
6HAL-HT.....	1800	264	692	900	1743
6HAL-T.....	1800	209	512	900	1289
6LAAL-DT.....	1800	530	1370	900	3450
6T95LE.....	2800	102	233	900	587
6T95LTE.....	2800	128	314	900	791
8LAAL-DT.....	1800	705	1800	900	4533

When all you have is a Donaldson part number, this section will lead you to the proper page in the catalog where specific information on that part number can be found.

In some cases you will find two separate page numbers listed, for products such as: mufflers (with references to the specifications section and the muffler selection by engine performance section); and clamps (with references to both dimensional and application information).

Part No.	Page	Part No.	Page	Part No.	Page	Part No.	Page	Part No.	Page	Part No.	Page
H000165.....	48	H001661.....	46	J000220.....	16	J009635.....	28	J034743.....	19	J240006.....	19
H000170.....	48	H001742.....	48	J000221.....	16	J009636.....	28	J034744.....	19	J240007.....	19
H000275.....	48	H001756.....	48	J000222.....	16	J009637.....	28	J034746.....	31	J240012.....	30
H000276.....	48	H001773.....	48	J000224.....	16	J009639.....	27	J038611.....	27	J240016.....	31
H000339.....	48	H001946.....	48	J000227.....	16	J009640.....	27	J038612.....	27	J240024.....	30
H000349.....	50	H001947.....	48	J000228.....	16	J009641.....	27			J340023.....	30
H000350.....	50	H001948.....	48	J000230.....	16	J009644.....	27	J092679.....	23	J540008.....	30
H000351.....	50	H002023.....	51	J000231.....	16	J009645.....	27	J092689.....	23	J640001.....	30
H000466.....	48	H002068.....	47	J000232.....	16	J009648.....	23			J640005.....	31
H000467.....	48	H002070.....	51	J000233.....	16	J009649.....	23	J190002.....	25		
H000468.....	48	H002129.....	37	J008167.....	24	J009650.....	23	J190003.....	25	M001327.....	29
H000469.....	48	H002132.....	37	J008671.....	25			J190004.....	25	M001432.....	14
H000470.....	48	H008441.....	51	J008681.....	25	J014621.....	31	J190013.....	26	M001502.....	14
H000471.....	48	H008442.....	51	J008942.....	22	J014622.....	31	J190014.....	26	M001503.....	14
H000472.....	48	H008443.....	51	J009391.....	21	J014623.....	31	J190016.....	26	M001504.....	14
H000473.....	48	H008444.....	51	J009393.....	21	J018110.....	27	J190017.....	26	M001505.....	14
H000483.....	49			J009429.....	33			J190019.....	26	M001506.....	14
H000484.....	49	H770037.....	50	J009479.....	21	J024735.....	30	J190020.....	26	M001566.....	14
H000604.....	48			J009486.....	16	J024737.....	30	J190023.....	27	M001593.....	14
H000605.....	48	J000127.....	29	J009487.....	16	J024739.....	30	J190025.....	27	M001668.....	14
H000606.....	48	J000200.....	16	J009514.....	36	J024746.....	31	J190027.....	27	M001702.....	14
H000607.....	48	J000201.....	16	J009516.....	36	J024747.....	31	J190041.....	22	M001703.....	14
H000722.....	38	J000202.....	16	J009518.....	36	J024748.....	31	J190042.....	23	M001756.....	14
H001023.....	38	J000203.....	16	J009547.....	25	J024749.....	31	J190044.....	23	M001799.....	14
H001032.....	38	J000204.....	16	J009560.....	26	J024750.....	31	J190045.....	23	M001865.....	14
H001033.....	38	J000205.....	16	J009604.....	16	J024751.....	31	J190046.....	22	M001866.....	14
H001034.....	38	J000206.....	16	J009605.....	16	J024754.....	19	J190054.....	16	M001867.....	14
H001035.....	38	J000207.....	16	J009606.....	16	J024755.....	19	J190055.....	16	M002117.....	17
H001039.....	38	J000208.....	16	J009607.....	16	J024757.....	31	J190056.....	16	M002118.....	17
H001053.....	48	J000209.....	16	J009611.....	20	J024758.....	31	J190057.....	16	M002119.....	17
H001063.....	48	J000210.....	16	J009612.....	20	J024835.....	19	J190058.....	16	M002120.....	17
H001200.....	46	J000211.....	16	J009613.....	20	J024836.....	19	J190059.....	16	M002121.....	17
H001278.....	38	J000212.....	16	J009614.....	20	J024837.....	19	J190060.....	16	M002122.....	17
H001279.....	38	J000213.....	16	J009618.....	20	J024838.....	19	J190061.....	16	M002123.....	17
H001284.....	38	J000214.....	16	J009623.....	16	J024850.....	19	J190062.....	16	M002134.....	14
H001377.....	47	J000215.....	16	J009624.....	16	J028528.....	27	J190063.....	16	M002135.....	14
H001378.....	47	J000216.....	16	J009629.....	21					M002164.....	14
H001379.....	47	J000217.....	16	J009631.....	28	J034673.....	19	J240003.....	19		
H001654.....	46	J000218.....	16	J009632.....	28	J034674.....	19	J240004.....	19		
H001660.....	46	J000219.....	16	J009633.....	28	J034725.....	31	J240005.....	19		

Part Number Index



Part No.	Page	Part No.	Page	Part No.	Page	Part No.	Page	Part No.	Page	Part No.	Page
M045123.....	32	M085421.....	61-66	M101181.....	61-66	P007191.....	50	P114313.....	40	P206286.....	27
M045193.....	61-66			M101182.....	61-66			P114314.....	39	P206297.....	23
M045237.....	61-66	M090009.....	61-66	M101263.....	61-66	P013722.....	50	P114315.....	40	P206298.....	23
		M090072.....	32			P016845.....	50	P114316.....	40	P206299.....	23
M060005.....	61-66	M090074.....	61-66	M110012.....	61-66			P114317.....	41	P206300.....	23
M060037.....	32	M090091.....	32	M110014.....	61-66	P100089.....	45	P114318.....	39	P206301.....	31
M060038.....	32	M090095.....	61-66	M110077.....	61-66	P101290.....	40	P114319.....	41	P206302.....	31
M060055.....	61-66	M090146.....	61-66	M110112.....	61-66	P101291.....	40	P115200.....	43	P206303.....	31
M060158.....	61-66	M090158.....	61-66	M110148.....	61-66	P101292.....	40	P115201.....	43	P206304.....	31
M060232.....	61-66	M090159.....	61-66	M110189.....	61-66	P101293.....	40	P115202.....	43	P206305.....	31
M060247.....	61-66	M090170.....	61-66	M110311.....	61-66	P101294.....	40	P115203.....	43	P206306.....	31
M060250.....	61-66	M090210.....	61-66	M110479.....	61-66	P101891.....	40	P115204.....	43	P206308.....	31
M060251.....	61-66	M090280.....	61-66	M110674.....	61-66	P102820.....	40	P115205.....	43	P206309.....	31
M060479.....	61-66	M090301.....	61-66	M110849.....	61-66	P102948.....	41	P115206.....	43	P206310.....	31
M060480.....	61-66	M090362.....	32	M111024.....	61-66	P103198.....	44	P115207.....	43	P206311.....	31
M060481.....	61-66	M090520.....	61-66	M111025.....	61-66	P103516.....	40	P115208.....	43	P206312.....	31
M060482.....	61-66	M090534.....	61-66	M111026.....	61-66	P104087.....	41	P115209.....	43	P206313.....	22
M060483.....	61-66	M090535.....	61-66	M111028.....	61-66	P104088.....	41	P117724.....	39	P206314.....	22
M065030.....	32	M090538.....	61-66	M111029.....	61-66	P104089.....	41			P206315.....	22
M065034.....	61-66	M090544.....	61-66	M120100.....	61-66	P104090.....	41	P121482.....	39	P206316.....	22
M065044.....	61-66	M090547.....	61-66	M120108.....	61-66	P105220.....	44	P122067.....	45	P206317.....	22
M065065.....	61-66	M090548.....	61-66	M120131.....	61-66	P105529.....	39	P123462.....	39	P206318.....	22
M065071.....	61-66	M090563.....	61-66	M120135.....	61-66	P105530.....	39	P126530.....	40	P206319.....	22
M065073.....	61-66	M090594.....	61-66	M120154.....	61-66	P105531.....	39	P128990.....	39	P206320.....	22
M065074.....	61-66	M090595.....	61-66	M120176.....	61-66	P105532.....	39	P129660.....	40	P206321.....	22
M065138.....	61-66	M090598.....	61-66	M120189.....	61-66	P105533.....	39	P133338.....	40	P206322.....	22
M065139.....	61-66	M090680.....	61-66	M120197.....	61-66	P105534.....	39	P133339.....	40	P206323.....	22
M065140.....	61-66	M090781.....	61-66	M120225.....	61-66	P105535.....	39	P136494.....	40	P206324.....	22
M065141.....	61-66	M090823.....	61-66	M120235.....	61-66	P105536.....	39			P206325.....	22
M065142.....	61-66	M091046.....	61-66	M120365.....	61-66	P105541.....	40	P143422.....	43	P206326.....	22
M070008.....	61-66	M091047.....	61-66	M120366.....	61-66	P105542.....	40	P143895.....	39	P206327.....	22
M070028.....	61-66	M091048.....	61-66	M120367.....	61-66	P105543.....	40	P148337.....	43	P206328.....	22
M070050.....	61-66	M091049.....	61-66	M120382.....	61-66	P105544.....	40	P148338.....	43	P206331.....	29
M070068.....	32	M091050.....	61-66	M120417.....	61-66	P105545.....	40	P148339.....	43	P206333.....	29
M070069.....	32			M120418.....	61-66	P105546.....	40	P148340.....	43	P206334.....	29
		M100016.....	32	M120448.....	61-66	P105547.....	40	P148341.....	43	P206335.....	29
M080018.....	61-66	M100043.....	61-66	M120450.....	61-66	P105548.....	40	P148342.....	43	P206336.....	29
M080024.....	32	M100048.....	61-66	M120566.....	61-66	P105608.....	41	P148343.....	43	P206337.....	29
M085008.....	61-66	M100049.....	61-66	M120598.....	61-66	P105609.....	41	P148344.....	43	P206338.....	29
M085023.....	61-66	M100052.....	61-66	M120713.....	61-66	P105610.....	41	P148345.....	43	P206339.....	25
M085056.....	61-66	M100146.....	61-66	M120747.....	61-66	P105611.....	41	P148346.....	43	P206340.....	25
M085078.....	61-66	M100213.....	61-66	M120748.....	61-66	P105612.....	41	P148347.....	43	P206341.....	25
M085080.....	61-66	M100463.....	61-66	M120749.....	61-66	P105613.....	41	P148348.....	43	P206342.....	25
M085084.....	61-66	M100464.....	61-66	M120750.....	61-66	P105622.....	45	P148349.....	43	P206343.....	25
M085090.....	61-66	M100465.....	61-66	M120751.....	61-66	P106593.....	44	P148350.....	43	P206344.....	25
M085171.....	61-66	M100466.....	61-66	M122300.....	61-66	P107844.....	39	P149099.....	44	P206345.....	25
M085172.....	61-66	M100572.....	61-66	M140048.....	61-66	P109021.....	40			P206346.....	26
M085189.....	61-66	M100580.....	61-66	M170101.....	61-66	P109331.....	40	P158914.....	44	P206347.....	25
M085206.....	61-66	M100582.....	61-66	M190002.....	61-66			P159820.....	39	P206348.....	25
M085207.....	61-66	M100695.....	61-66							P206349.....	26
M085208.....	61-66	M100807.....	61-66	P002348.....	50	P111414.....	41			P206350.....	25
M085226.....	61-66	M100944.....	61-66	P002351.....	50	P112605.....	39	P205834.....	36	P206353.....	25
M085267.....	61-66	M101158.....	61-66	P003245.....	50	P112606.....	40	P205976.....	23	P206354.....	25
M085293.....	61-66	M101159.....	61-66	P004073.....	50	P112607.....	40	P205979.....	23	P206355.....	25
M085407.....	61-66	M101167.....	61-66	P004076.....	50	P112608.....	41	P206279.....	27	P206361.....	22
M085408.....	61-66	M101168.....	61-66	P004079.....	50	P112609.....	40	P206280.....	27	P206362.....	22
M085409.....	61-66	M101169.....	61-66	P004307.....	50	P112610.....	40	P206281.....	27	P206363.....	22
M085410.....	61-66	M101170.....	61-66	P004906.....	50	P112611.....	40	P206282.....	27	P206364.....	22
M085411.....	61-66	M101171.....	61-66	P007189.....	50	P112803.....	44	P206283.....	27	P206365.....	22
						P113733.....	39	P206285.....	27	P206366.....	22

Part No.	Page	Part No.	Page	Part No.	Page	Part No.	Page	Part No.	Page	Part No.	Page
P206367	22	P206540	33	P207318	31	P207581	21	P222744	16	P224696	30
P206368	22	P206542	33	P207319	31	P207582	21	P222745	16	P224698	30
P206369	22	P206543	25	P207320	31	P207584	21	P222746	16	P224699	30
P206370	22	P206544	19	P207321	31	P207596	16	P222747	16	P224701	30
P206371	22	P206546	19	P207322	26	P207598	16	P222748	16	P224703	30
P206372	22	P206547	19	P207324	26	P207619	21	P222749	16	P224706	31
P206373	22	P206552	19	P207325	26	P207620	21	P222750	16	P224707	31
P206374	22	P206553	19	P207326	26	P207667	16	P222751	16	P224709	31
P206375	22	P206554	19	P207327	26	P207784	24	P222752	16	P224710	31
P206376	30	P206555	19	P207328	26	P208324	30	P222753	16	P224711	31
P206377	30	P206556	19	P207329	26	P208326	31	P222754	16	P224841	33
P206378	30	P206559	19	P207330	26	P208328	30	P222755	16	P226129	18
P206379	30	P206600	16	P207331	26	P208330	31	P222756	16	P226132	18
P206380	31	P206601	16	P207332	26	P208336	30	P222757	16	P226133	18
P206381	31	P206602	16	P207333	25	P208338	31	P222758	16	P226135	18
P206382	31	P206603	16	P207335	25	P208348	30	P222759	16	P226137	18
P206383	31	P206604	20	P207338	25	P208350	31	P222760	16	P226138	18
P206384	31	P206605	20	P207339	25	P208358	31	P224412	19	P226140	18
P206385	31	P206606	20	P207340	25	P208359	31	P224415	19	P226141	18
P206386	31	P206607	20	P207341	25	P208364	30	P224418	19	P226142	18
P206387	31	P206608	16	P207345	25	P208366	31	P224421	19	P226143	18
P206388	30	P206609	16	P207346	25	P208374	31	P224479	19	P226144	18
P206389	30	P206610	16	P207347	28	P208375	31	P224481	19	P226145	18
P206390	30	P206611	16	P207349	28	P208380	30	P224492	25	P226146	18
P206391	30	P206612	21	P207350	28	P208382	30	P224515	19	P226147	18
P206393	28	P206613	21	P207351	28	P208385	30	P224518	19	P226148	18
P206394	28	P206614	21	P207352	28	P208386	31	P224521	19	P226149	18
P206395	28	P206615	21	P207353	28	P208388	31	P224581	29	P226150	18
P206396	28	P206616	36	P207354	28	P208389	31	P224582	29	P226151	18
P206397	26	P206617	36	P207355	28	P208392	31	P224589	30	P226152	18
P206398	26	P206641	36	P207359	27	P208393	30	P224590	30	P226153	18
P206399	26	P206849	29	P207361	26	P208394	31	P224600	31	P226154	18
P206400	26	P206850	29	P207362	26	P208395	31	P224604	30	P226155	18
P206403	16	P206851	29	P207363	26	P209910	31	P224605	30	P226156	18
P206404	16	P206927	31	P207364	26	P209912	31	P224606	30	P226157	18
P206405	16	P207281	30	P207365	26	P209913	31	P224607	30	P226158	18
P206406	16	P207282	30	P207366	26	P210110	20	P224608	30	P226164	18
P206407	16	P207283	30	P207367	29	P212925	20	P224609	30	P226165	18
P206408	16	P207285	30	P207368	29	P213191	20	P224611	30	P226166	18
P206409	16	P207286	30	P207369	29	P216169	28	P224614	30	P226167	18
P206410	16	P207287	30	P207382	22	P216172	25	P224616	30	P226914	34
P206411	16	P207288	30	P207385	22	P216174	26	P224617	31	P226914	34
P206507	24	P207289	30	P207386	22	P216175	26	P224618	31	P227167	34
P206508	25	P207290	31	P207389	22	P216191	30	P224627	30	P227167	34
P206509	25	P207292	30	P207394	22	P216197	30	P224628	30	P227170	34
P206510	33	P207293	31	P207397	22	P216200	31	P224633	31	P227170	34
P206511	33	P207295	31	P207401	22	P216202	31	P224635	31	P227175	34
P206512	33	P207296	31	P207402	22	P216204	31	P224636	31	P227175	34
P206515	33	P207297	31	P207405	22	P216205	31	P224638	31	P227178	34
P206516	33	P207298	31	P207408	22	P216206	31	P224641	31	P227178	34
P206517	33	P207299	30	P207411	22	P216227	30	P224654	31	P227179	33
P206518	33	P207300	30	P207413	22	P216228	30	P224669	25	P227179	33
P206519	33	P207301	31	P207414	22			P224671	25	P227182	35
P206520	33	P207302	31	P207415	31	P222017	20	P224684	29	P227182	35
P206521	33	P207308	31	P207419	31	P222018	20	P224685	29	P227215	34
P206523	24	P207309	31	P207559	31	P222740	16	P224686	29	P227215	34
P206524	24	P207312	31	P207566	21	P222741	16	P224687	29	P227728	34
P206525	24	P207314	30	P207567	21	P222742	16	P224692	29	P227728	34
P206526	24	P207317	30	P207568	21	P222743	16	P224693	29	P227750	20

Part Number Index



PART NUMBER INDEX

Part No.	Page	Part No.	Page	Part No.	Page	Part No.	Page	Part No.	Page
P227750	20	P525956	44	X001966	47				
P227803	17	P532919	43	X001988	47				
P227803	17	P532920	43	X002014	47				
P227804	17	P532921	43	X002015	47				
P227804	33	P532922	43	X002017	47				
P227805	34	P532923	43	X002018	47				
P227805	34	P532924	43	X002019	47				
P227839	35	P532925	43	X002101	45				
P227839	35	P532926	43	X002102	45				
P228241	17	P532927	43	X002103	45				
P228241	33	P532928	43	X002275	45				
P228258	34	P532929	43	X002277	45				
P228258	34	P532943	42	X002278	45				
P228260	35	P532944	42	X003691	49				
P228260	35	P532945	42	X004476	15				
P229114	35	P532948	42	X004478	15				
P229114	35	P532949	42	X004480	15				
P229513	17	P532950	42	X004482	15				
P229513	33	P532951	42	X004484	15				
P229851	20	P532952	42	X004536	15				
P229851	20	P532953	42	X004537	15				
		P532954	42	X004538	15				
P230045	17	P532956	42	X004539	15				
P230046	34	P532957	42	X004962	15				
P230047	34	P532958	42	X005207	33				
P230241	33	P532959	42	X006202	15				
P230281	17	P532960	42	X006203	15				
P230282	17	P532961	42	X006204	15				
P230283	17	P532962	42	X007276	45				
P230284	34	P535571	42	X007335	45				
P230761	33	P535572	42	X007784	15				
P230762	33	P535573	42	X007785	15				
P233421	33	P536163	39	X007805	15				
P233422	33	P537468	39	X007824	15				
P270530	24			X007829	15				
P270531	24	P540256	40	X007830	15				
P270532	24	P547694	41	X007831	15				
P270533	24			X007832	15				
P270534	24	P600325	41	X007833	15				
P270535	24	P600326	41	X007834	15				
P270536	24	P600327	41	X007968					
P270538	24	P600328	41	X009076	15				
P270539	24	P604045	40						
P270540	24								
P270541	24	P617632	44						
P270542	24								
P270543	24	P776008	44						
P270837	24	P777151	51						
P270838	24	P777730	51						
P271507	24	P777731	51						
P271508	24	P777732	51						
P271511	24	P778810	51						
P520882	40	P780532	51						
P520883	40	P780594	51						
P520884	40								
P522439	50	X001744	49						
P522958	44	X001746	49						
P524552	50	X001747	49						



Global Presence with Local Touch

Donaldson has established a global distribution network to serve our customers locally as well as worldwide. We operate as a global company with a network of primary distribution locations that support a mature hub of regional distribution centers and warehouses.

Donaldson distribution centers are strategically located to quickly and accurately deliver filtration and exhaust products wherever replacement products are needed. We work with a

network of transportation, third party logistics companies, consolidators, and cross-docking facilities to meet or exceed our customers' requirements.

All regions of the world benefit from our global umbrella of distribution centers. We focus our efforts on local support and the capabilities of our staff. We continue to make significant investments in facilities, systems, supply chain relationships and staffing to offer the best order fulfillment options available.



Donaldson Company, Inc.
PO Box 1299
Minneapolis, MN
55440-1299

www.donaldson.com
www.buydonaldson.com

North America 800-374-1374
Mexico +52-449-910-6150
Latin Am. +52-449-910-6150
Brazil +55-11-2119-1604
Europe +32-16-38-3811

Catalog No. F110028 ENG (11/12)

South Africa +27-11-997-6000
South East Asia 65-6311-7373
Greater China 852-2405-8388
Japan 81-42-540-4112
South Korea 82-2-517-3333
Australia 61-02-4350-2033
India +91-124-2290060